

General Catalog

Cutting Tools and Tool Holders

Metric Catalog 60

Providing the World with the Cutting Edge!

for
38 Years!

Building 1 - Main Offices

7803 Hansen Road • Houston, TX 77061

Houses the administration offices and the insert manufacturing facilities.



Building 2 - Engineering/Mill Department

7811 Hansen Road • Houston, TX 77061

Houses the engineering department as well as manufacturing of standard and special tool holders.



Since 1978 Tool-Flo has been providing quality cutting tools for companies around the world.

Our corporate mission calls for us to achieve and maintain leadership by designing and manufacturing standard and special cutting tools and tool holders that bring our customers an unparalleled level of satisfaction. Tool-Flo's ongoing commitment in pursuit of that goal is to produce "ultimate quality" cutting tools that exceed customer's expectations through meticulous manufacturing and innovative use of the latest state of the art CNC machine tools.

Grade Crossover Chart

	Carboloy®	Iscar®	Kennametal®	Sandvik®	Teledyne	Valenite®	Vardex®
GF1			K1				
GP4						V1N	
AC4							
C22							
GP22	CP50	IC908	KC722	GC1020		VC927	
AC22	CP500						
GP222							
AC222							
C25	HX	IC20	K68		HTA		VK2
GP25					TP21		
AC25							
C26S							
GP26							
AC26							
C2	883	IC20					
GP2							
AC2							
C3			K313	H13A			
GP3			KC730				VKX
AC3			KC5010				VTX
GP50	CP30	IC250	KC810/KC850	225G		VN8	
AC50	CP300		KC5025	225G			VSX
AG50	560		KC950				
G50							
C5H	P30		K420	S4			
GP5			KC710/KC810	GC135		VN5	
AC5							
C6H	S10M	IC50M		SM			V30
GP6	550	IC656				VN8	
AC6							VSX
M6		IC20N	KT175		SD5	VC671	VX5
GPM6			KT315				
M3							
CB200			KD120			VC722	
CB400			KD050	CB20		VC734	
DX200							
PC33			KD100			VC727	

Building 3 - Training Center/Shipping/Coating

8930 Tallyho • Houston, TX 77061

Technical training for end users, distributors and representatives, shipping, coating and inspection.



Building 4 - Manufacturing

7815 Hansen Road • Houston, TX 77061

Houses the sales department and the insert manufacturing processes.



Coolant-Fed Clamps

Patent pending

Can be used with low pressure
or high pressure coolant
(rated up to 1500 psi)

- Available for #2, 3 & 4 Flo-Lock right and left hand inserts

- Fits other brand's standard holders

- Available in 6 and 12 pack quantities for an added cost savings!



Use Your Existing Holders!

Simply replace the top clamp on your standard holder.

6mm High Pressure Coolant Kit

6MM COOLANT KIT HIGH PRESSURE

EDP code: 9HCPKIT6MHP

Kit comes complete with:

1 pc	M6X1 Elbow Coolant Fitting
1 pc	M6x1 Straight Coolant Fitting
1 pc	.125 (1/8")x1 Elbow Coolant Fitting
1 pc	.125 (1/8")x1 Straight Coolant Fitting
1 pc	6mm High Pressure Coolant Hose

Clamp not included. Sold separately.

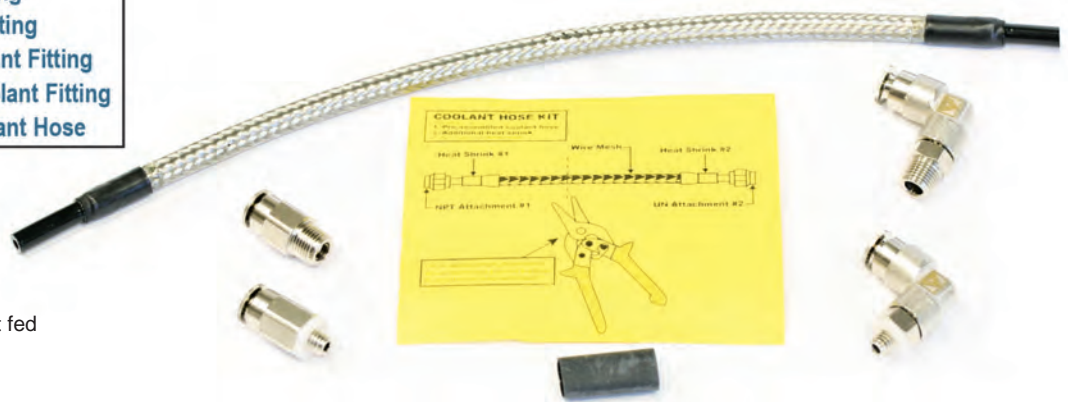

See page 60 for listing of coolant fed clamps.

INDEX

ALPHABETICAL INDEX. . . . 3

FLO LOCK CROSS REFERENCE. .84

GRADE CHART IBC

INSERTS

ACME THREADING

Bantam Series BHR4	56
Flo Lock	94
LT-Series Laydown	111
L-Series Laydown	125, 126
On Edge	142, 143
Threadmilling	176
Vee Bottom	208, 215

ACME THREADING (Partial topping)

Flo-Lock	95
LT-Series Laydown	111
On-Edge	144, 147

ACME STUB THREADING

Bantam Series BHR4	56
Flo Lock	94, 95
LT-Series Laydown	111
L-Series Laydown	126, 127
On Edge	143-145
Vee Bottom	208, 215

ACME STUB THREADING (Partial topping)

Flo-Lock	95
LT-Series Laydown	111
On-Edge	146, 147

AMERICAN STANDARD BUTTRESS

Flo Lock	96
On Edge	147

API BUTTRESS THREADING

Chasers	6, 62
Flo Lock	8, 96
LT-Series Laydown	10, 112
L-Series Laydown	14, 127
On Edge	18, 147, 148
Vee Bottom	20, 208

API HUGHES H90 THREADING

L-Series Laydown	14, 127
On Edge	18, 148
Vee Bottom	208

API ROTARY SHOULDER

CONNECTION THREADING

Flo Lock	8, 97
LT-Series Laydown	12, 112
L-Series Laydown	15, 16, 127, 128
On Edge	19, 148, 149
Vee Bottom	20, 208

API ROUND THREADING

Chasers	6, 62
Flo Lock	8, 9, 97
LT-Series Laydown	12, 13, 112, 113
L-Series Laydown	17, 129
On Edge	19, 149
Threadmilling	175
Vee Bottom	20, 209

API VAM THREADING

LT-Series Laydown	13, 113
L-Series Laydown	17, 130
On Edge	149
Vee Bottom	20, 209

API V0.055 (MT) THREADING

LT-Series Laydown	13, 113
-----------------------------	---------

API X-LINE THREADING

LT-Series Laydown	13, 113
L-Series Laydown	17, 130
On Edge	150
Vee Bottom	21, 209

BALLNOSE

Finishing	36, 37
Roughing	37
Flat Bottom	39
Back Draft	39

BORING

Bantam Series	45-49
-------------------------	-------

BSPP THREADING

Threadmilling	174
-------------------------	-----

BSPT THREADING

LT-Series Laydown	117
Threadmilling	174

CHIP BREAKERS

Chaser	7, 63, 64
Flo-Lock	33, 78, 80, 85, 87, 89-91
Laydown (LT)	10, 16, 117, 119
Laydown (L)	128
Vee Bottom	81, 210, 211

COOLANT FED CLAMPS. . . . 2, 6, 106

CUTOFF 68-70

DEEP GROOVING

Flo Lock	73, 74, 90-92
Vee Bottom	72, 210

FACE GROOVING

Flo Lock	78, 79
Vee Bottom	80, 81

GROOVING

Bantam Series	49-51
Flo Lock	85-92
LT-Series Laydown	114
Milling	139, 179
On Edge	150-152
Vee Bottom	210-212, 215

ISO THREADING

Bantam	52, 53, 55
LT-Series Laydown	114, 115
Threadmilling	174, 176-178

KITS .

Bantam Series	57
Flo Lock	104
High Pressure Coolant	60, 105
Threadmill	179

MILLING 138, 139

NPT THREADING

Bantam Series	52-55
Chasers	7, 63
Flo Lock	9, 97, 98
LT-Series Laydown	10, 11, 115, 116
L-Series Laydown	14, 15, 130
On Edge	152
Threadmilling	173, 212
Threadmilling (Solid)	175, 178
Vee Bottom	212

NPTF DRYSEAL THREADING

LT-Series Laydown	116
Threadmilling	178

PCBN 159-163

PITTSBURG ACME

L-Series Laydown	15, 131
----------------------------	---------

POLY-VEE

Flo Lock	33, 101
PV Series	32

PROFILING 166, 167

RING GROOVERS 21

TRAPEZOIDAL THREADING

LT-Series Laydown	116
-----------------------------	-----

TUBE SCARFING 26

TURNING 182-184

UN THREADING

Bantam Series	52-55
Flo Lock	99
LT-Series Laydown	117, 118
Threadmilling	173-176
Threadmilling (Solid)	178

UNJ THREADING

Flo Lock	98, 99
LT-Series Laydown	119, 120
Threadmilling	173-177

V- THREADING

Bantam Series	52-57
Flo Lock	100, 101
LT-Series Laydown	119
L-Series Laydown	131
On Edge	152, 153
Vee Bottom	212, 215

WHEEL TURNING

DBV Series	34
----------------------	----

WHITWORTH THREADING

LT-Series Laydown	120, 121
On-Edge	153

BRAZED TOOLS 27, 28

TOOLHOLDERS/BARS

BALLNOSE	37-39
BANTAM SERIES	45-57
CHASERS	64
COMBO BAR	65
CUT OFF	68-70
DEEP GROOVING	73-75
FACE GROOVING	79, 80
FLO LOCK	101-104
GROOVEMILLING	179
LT-SERIES LAYDOWN	121, 122
L-SERIES LAYDOWN	132-134
ON EDGE	154-156
PROFILING	167-170
PV SERIES	33
RING GROOVING	22
SWISS TOOLING	59
THREADMILLING	173, 174, 177
TURNING	185-200
VEE BOTTOM	81, 213, 214, 216
WHEEL TURNING (DBV)	34

INTERCHANGABLE HEADS. 22-26, 104, 122, 201-214, 216

PARTS. 218-221

TECHNICAL DATA. 222-228

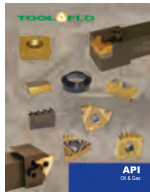

API

Inserts.....	6-21
Holders.....	22
Interchangeable Heads.....	22-25
Brazed.....	27,28
Technical.....	29,30

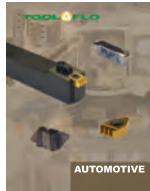

AUTOMOTIVE

Inserts.....	32-34
Holders.....	33,34
Technical.....	34

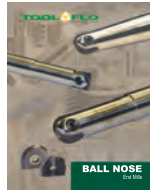

BALLNOSE

Inserts.....	36,37,39
Holders.....	37-39
Technical.....	40-42



BANTAM/SWISS TOOLING

Inserts.....	45-57
Holders.....	45-57
Kits.....	57
Technical.....	58



CHASERS

Inserts.....	62-64
Inserts.....	62-64
Holders.....	64
Technical.....	65,66



CUT OFF

Inserts.....	68
Holders.....	68-70
Technical.....	70



DEEP GROOVING

Inserts.....	72-74
Holders.....	73,75
Technical.....	76



FACE GROOVING

Inserts.....	78-81
Holders.....	79-81
Technical.....	82



FLO-LOCK

Inserts.....	85-92,94-101
Holders.....	101-104
Kits.....	104
Technical.....	93,107,108



LAYDOWN

	LT STYLE	L STYLE
Inserts.....	111-121	125-131
Holders.....	121-122	132-134
Technical.....	123-124	

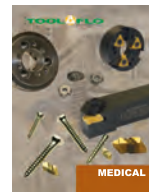

MEDICAL

General.....	136
--------------	-----



MILLING

Inserts.....	138, 139
Groove Milling.....	139
Technical.....	140



ON EDGE

Inserts.....	142-153
Holders.....	154-156



PCBN

Inserts.....	159-163
Technical.....	164



PROFILING

Inserts.....	166,167
Holders.....	167-170



THREADMILLING

Inserts.....	172-177
Holders.....	173,174,177
Kits.....	179
Solids.....	178
Technical.....	180



TURNING

Inserts.....	182-184
Holders.....	185-200
Interchangeable Heads.....	201-204
Technical.....	205,206



VEE BOTTOM

Inserts.....	208-212,215
Holders.....	213,214,216
Interchangeable Heads.....	216



SPARE PARTS

GENERAL TECHNICAL

Parts.....	217-221
Technical.....	222-228

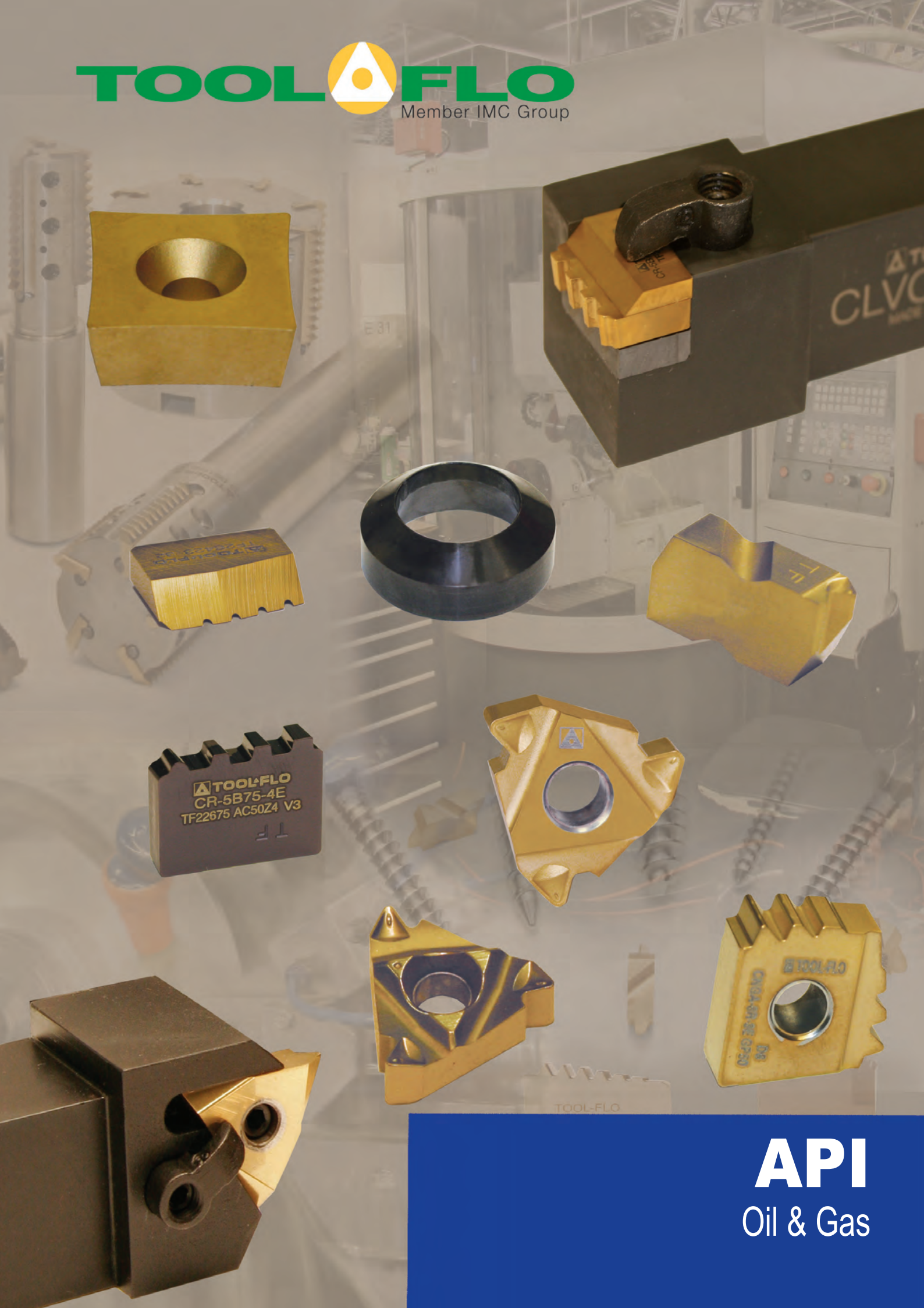

CHASERS

External API Buttress

■ For holders see pg. 64

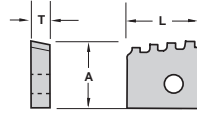

Description	EDP Code	TPI	TPF	Dimensions (mm)			No. of Teeth				
				L	A	T		G50	GP50	ZA3	AC50
CR-5B75-3E #1	M16415188	5	3/4	17.02	14.55	5.21	3	●	●	●	●
CR-5B75-3E #2	M16415189	5	3/4	17.02	14.78	5.21	3	●	●	●	●
CR-5B75-3E #3	M16426149	5	3/4	17.02	14.99	5.21	3	●	●	●	●
CR-5B75-4E	M16422675	5	3/4	20.42	15.88	5.08	4	●	●	●	●
CR-5B1-4E	M1741130	5	1	20.32	16.26	5.08	4	●	●	●	●
CR-8B75-4E	M2145353	8	3/4	20.32	15.37	5.08	4	●	●	●	●

CVD Coated	TiN Coated	AlTiN Coated
●	●	●
●	●	●
●	●	●
●	●	●
●	●	●
●	●	●

Internal API Buttress

■ For bars see pg. 64

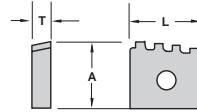

Description	EDP Code	TPI	TPF	Dimensions (mm)			No. of Teeth				
				L	A	T		G50	GP50	ZA3	AC50
CR-5B75-2I	M16828936	5	3/4	16.00	15.79	5.18	2	●	●	●	●
CR-5B75-3I	M1681847	5	3/4	16.00	14.66	5.18	3	●	●	●	●
CR-5B75-4I	M1681347	5	3/4	20.32	14.78	5.21	4	●	●	●	●
CR-5B75-5I	M16815688	5	3/4	25.40	14.99	5.21	5	●	●	●	●
CR-5B1-3I	M1782052	5	1	16.13	16.13	5.08	3	●	●	●	●
CR-5B1-4I	M1782051	5	1	20.32	16.26	5.08	4	●	●	●	●
CR-8B75-4I	M2185353	8	3/4	20.32	14.99	5.21	4	●	●	●	●

G50	GP50	ZA3	AC50
●	●	●	●
●	●	●	●
●	●	●	●
●	●	●	●
●	●	●	●
●	●	●	●

External API Round

■ For holders see pg. 64

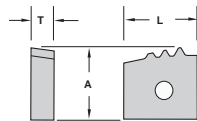

Description	EDP Code	TPI	TPF	Dimensions (mm)			No. of Teeth				
				L	A	T		G50	GP50	AC50	
CR-8R-3E #1	M32416731	8	3/4	16.00	14.66	5.18	3	●	●	●	
CR-8R-3E #2	M32416732	8	3/4	16.00	14.88	5.18	3	●	●	●	
CR-8R-3E #3	M32416733	8	3/4	16.00	15.01	5.18	3	●	●	●	
CR-8R-3E	M32419310	8	3/4	16.00	15.04	5.18	3	●	●	●	
CR-8R-4E 6°	M3241136	8	3/4	16.26	15.88	5.08	4	●	●	●	
CR-8R-4E 12°	M3241163	8	3/4	16.13	15.88	5.08	4	●	●	●	
CR-10R-3E #1	M34416728	10	3/4	15.95	14.30	5.18	3	●	●	●	
CR-10R-3E #2	M34416729	10	3/4	15.95	14.53	5.18	3	●	●	●	
CR-10R-3E #3	M34416730	10	3/4	15.95	14.61	5.18	3	●	●	●	
CR-10R-3E	M3441291	10	3/4	16.00	15.88	5.18	3	●	●	●	

G50	GP50	AC50
●	●	●
●	●	●
●	●	●
●	●	●
●	●	●
●	●	●
●	●	●
●	●	●
●	●	●
●	●	●

External API Round and Buttress Chaser Style

CNGA - Double Sided (2 cutting edges)

■ For holders see pg. 64

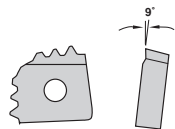

Description	EDP Code	TPI	TPF	No. of Teeth	G50	GP50	ZA3	AC50
CNGA-8R-3E	M32427407	8	3/4	3	●	●	●	●
CNGA-10R-3E	M34427408	10	3/4	3	●	●	●	●
CNGA-5B75-3E	M16427408	5	3/4	3	●	●	●	●

G50	GP50	ZA3	AC50
●	●	●	●
●	●	●	●
●	●	●	●

Internal API Round

■ For bars see pg. 64

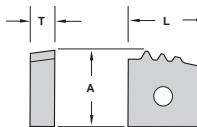

Description	EDP Code	TPI	TPF	Dimensions (mm)			No. of Teeth				
				L	A	T		G50	GP50	AC50	
CR-8R-3I	M3287464	8	3/4	16.26	15.04	5.08	3	●	●	●	
CR-8R-4I 6°	M3281136	8	3/4	16.26	15.88	5.08	4	●	●	●	
CR-8R-4I	M32819437	8	3/4	16.26	15.88	5.08	4	●	●	●	
CR-8R-4I	M32825150	8	3/4	16.26	15.88	5.08	4	●	●	●	
CR-8R-7I	M32814828	8	3/4	25.40	15.88	5.08	7	●	●	●	
CR-8R-7I	M32817968	8	3/4	25.40	15.88	5.08	7	●	●	●	
CR-10R-3I	M3481291	10	3/4	16.00	15.88	5.08	3	●	●	●	

G50	GP50	AC50
●	●	●
●	●	●
●	●	●
●	●	●
●	●	●
●	●	●

In an effort to improve our stock standard grade offering, there are periodic changes. Please see current price list for up to date grade offering.

- High performance choice in optimal conditions.
- ▲ Recommended grade under general conditions.

J-Series	▲	●
K-Series	▲	●
L-Series	▲	●
N-Series	●	▲
P-Series	●	▲
Q-Series	●	●



CHASERS

External LPT/NPT

■ For holders see pg. 64

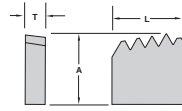

Description	EDP Code	TPI	TPF	Dimensions (mm)			No. of Teeth	CVD Coated	TIN Coated	AlTiN* Coated
				L	A	T				
CR-8NPT-4E	M3648996	8	3/4	15.88	15.75	5.16	4	●	●	●
CR-11.5NPT-4E	M3649668	11.5	3/4	15.88	15.75	4.76	4	●	●	●
CR-8P-3E WW	M50928966	8	0	16.00	15.03	5.16	3	●	●	●

Internal LPT/NPT

■ For bars see pg. 64

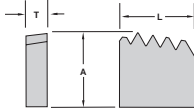

Description	EDP Code	TPI	TPF	Dimensions (mm)			No. of Teeth	G50	GP50	AC3	AC50
				L	A	T					
CR-8NPT-4I	M3689804	8	3/4	15.88	15.75	5.16	4	●	●	●	●
CR-11.5NPT-4I	M3689804	11.5	3/4	15.88	15.75	4.76	4	●	●	●	●
CR-8NPT-7I	M3689804	8	3/4	25.40	15.62	5.08	7	●	●	●	●
CR-8P-3I	M50828192	8	0	16.00	15.03	5.16	3	●	●	●	●

CHIPBREAKERS

External

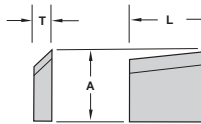

Description	EDP Code	Dimensions (mm)			Inserts
		L	A	T	
CR-5B75/5B1-4E-CB	TF2993	20.32	12.70	3.18	CR-5B75-4E/CR-5B1-4E
CR-8R/10R-3E/4E-CB	TF1353E	16.00	11.68	3.18	CR-8R-3E/CR-8R-4E/CR-10R-3E/CR-8NPT-4E
#3 CB W/O COOLANT GROOVES .170	TF26424	15.70	11.68	4.32	CR-8R-3E/CR-8R-4E/CR-10R-3E/CR-8NPT-4E

External

with coolant grooves

Also available at -0.25, -0.50 and -0.76 off the A dimension.

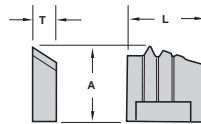

Description	EDP Code	Dimensions (mm)			Coolant Grooves	Inserts
		L	A	T		
TD4601 5B75-1-CB	TF16660	16.89	13.97	4.32	✓	CR-5B75-3E #1
TD4602 5B75-2-CB	TF16661	16.97	13.97	4.32	✓	CR-5B75-3E #2
TD4603 5B75-3-CB	TF16662	16.89	14.22	4.32	✓	CR-5B75-3E #3
TD3931 8R-1-CB	TF16657	15.95	13.16	4.19	✓	CR-8R-3E #1
TD3932 8R-2-CB	TF16658	16.13	13.36	4.19	✓	CR-8R-3E #2
TD3933 8R-3-CB	TF27129	15.95	13.21	4.19	✓	CR-8R-3E #3
TA2237 10R-1-CB	TF16760	15.95	12.78	4.45	✓	CR-10R-3E #1
TA2238 10R-2-CB	TF16761	15.95	13.00	4.45	✓	CR-10R-3E #2
TA2239 10R-3-CB	TF16762	15.95	13.08	4.45	✓	CR-10R-3E #3
#3 CB W/COOLANT GROOVES .170	TF26423	15.70	11.68	4.32	✓	CR-8R-3E

External

with coolant grooves and cavity

Also available at -0.25, -0.50 and -0.76 off the A dimension.

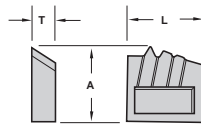

Description	EDP Code	Dimensions (mm)			Coolant Grooves	Inserts
		L	A	T		
TD4601 5B75-1-CB W/CAVITY	TF30297	16.89	13.97	4.32	✓	CR-5B75-3E #1
TD4602 5B75-2-CB W/CAVITY	TF30298	16.97	13.97	4.32	✓	CR-5B75-3E #2
TD4603 5B75-3-CB W/CAVITY	TF30299	16.89	14.22	4.32	✓	CR-5B75-3E #3
TD3931 8R-1-CB W/CAVITY	TF28130	15.95	13.16	4.19	✓	CR-8R-3E #1
TD3932 8R-2-CB W/CAVITY	TF28131	16.13	13.36	4.19	✓	CR-8R-3E #2
TD3933 8R-3-CB W/CAVITY	TF28132	15.95	13.21	4.19	✓	CR-8R-3E #3

Internal

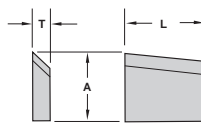

Description	EDP Code	Dimensions (mm)			Coolant Grooves	Inserts
		L	A	T		
CR-5B75/5B1-4I-CB	TF16104	20.32	12.70	3.18		CR-5B75-4I/CR-5B1-4I
CR-8R/10R-3I/4I-CB	TF1353I	16.00	12.40	3.18		CR-8R-3I/CR-8R-4I/CR-10R-3I/CR-8LPT-4I
CR-5B75-5I-CB	TF28765	25.40	13.72	3.18	✓	CR-5B75-5I
CR-8R-7I-CB	TF3435	25.40	13.21	3.18		CR-8R-7I
CR-8R-7I-CB	TF18096	25.40	12.95	3.18	✓	CR-8R-7I



FLO-LOCK

API Buttress Threading

■ For holders and bars see pgs. 101-104

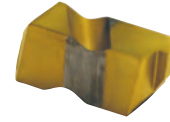
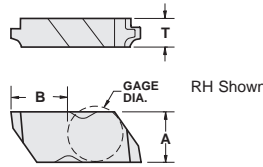

Description	EDP Code	TPI	TPF	Dimensions (mm)					Gage Dia.	C3	Uncoated	GP3	GP50	AC3	AC50
				T	A	B									
FLDC-3-5B75E	553616E	5	3/4	6.35	8.74	10.23	9.53					●			
FLDC-3-5B75I	553616I	5	3/4	6.35	8.74	10.23	9.53					●			
FLDC-3-5B1E	553617E	5	1	6.35	8.74	10.23	9.53					●			
FLDC-3-5B1I	553617I	5	1	6.35	8.74	10.23	9.53					●			
FLDC-4-5B75E	554616E	5	3/4	6.48	11.51	16.05	9.53					●			
FLDC-4-5B75I	554616I	5	3/4	6.48	11.51	16.05	9.53					●			
FLDC-4-5B1E	554617E	5	1	6.48	11.51	16.05	9.53					●			
FLDC-4-5B1I	554617I	5	1	6.48	11.51	16.05	9.53					●			

API Threading Non-Topping

■ For holders and bars see pgs. 101-104

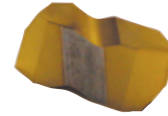
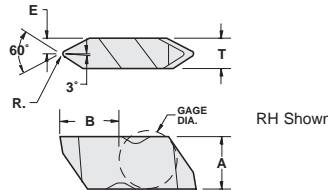

Description	EDP Code	TPI	Dimensions (mm)					Gage Dia.	C3	Uncoated	GP3	GP50	AC3	AC50
			R	T	E	A	B							
FLD-3038R	553438R	4	0.84/0.97	4.95	2.08	8.74	10.14	9.53				●		
FLD-3038L	553438L	4	0.84/0.97	4.95	2.08	8.74	10.14	9.53				●		
FLD-3040R	553440R	5	0.38/0.51	4.95	2.08	8.74	10.14	9.53				●		
FLD-3040L	553440L	5	0.38/0.51	4.95	2.08	8.74	10.14	9.53				●		
FLD-4038R	554438R	4	0.84/0.97	6.48	3.25	11.51	15.98	9.53				●		
FLD-4038L	554438L	4	0.84/0.97	6.48	3.25	11.51	15.98	9.53				●		
FLD-4040R	554440R	5	0.38/0.51	6.48	3.25	11.51	15.98	9.53				●		
FLD-4040L	554440L	5	0.38/0.51	6.48	3.25	11.51	15.98	9.53				●		
FLD-4050R	554450R	4	0.51/0.64	6.48	3.25	11.51	15.98	9.53				●		
FLD-4050L	554450L	4	0.51/0.64	6.48	3.25	11.51	15.98	9.53				●		

API Rotary Shoulder Connexion Threading

■ For holders and bars see pgs. 101-104

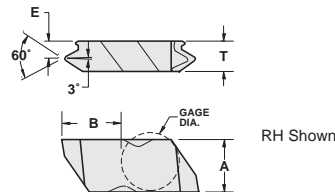

Description	EDP Code	TPI	TPF	Dimensions (mm)					Gage Dia.	Conn. No. or Size	GP3	GP50	AC22	AC3	AC50
				T	E	A	B								
FLDC-3-530E	553613E	5	3	6.35	3.73	8.74	10.23	9.53	3-1/2 FH, 2-3/8-4-1/2 Reg.		●				
FLDC-3-530I	553613I	5	3	6.35	3.73	8.74	10.23	9.53	3-1/2 FH, 2-3/8-4-1/2 Reg.		●				
FLDC-4-425E	554609E	4	2	7.92	4.65	11.51	16.05	9.53	5-1/2 FH, 6-5/8 FH & Reg.		●				
FLDC-4-425I	554609I	4	2	7.92	4.65	11.51	16.05	9.53	5-1/2 FH, 6-5/8 FH & Reg.		●				
FLDC-4-428E	554610E	4	2	7.92	4.65	11.51	16.05	9.53	NC23-NC50, 2-3/8-5-1/2IF		●	●			●
FLDC-4-428I	554610I	4	2	7.92	4.65	11.51	16.05	9.53	NC31-NC50, 2-7/8-5-1/2IF		●	●			●
FLDC-4-435E	554611E	4	3	7.92	4.65	11.51	16.05	9.53	5-1/2, 7-5/8, 8-5/8 Reg.		●				
FLDC-4-435I	554611I	4	3	7.92	4.65	11.51	16.05	9.53	5-1/2, 7-5/8, 8-5/8 Reg.		●				
FLDC-4-438E	554612E	4	3	7.92	4.65	11.51	16.05	9.53	NC56 - NC71		●				
FLDC-4-438I	554612I	4	3	7.92	4.65	11.51	16.05	9.53	NC56 - NC71		●				

API Round Threading

■ For holders and bars see pgs. 101-104

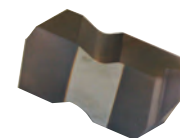
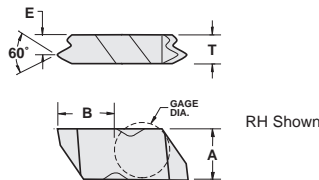

Description	EDP Code	TPI	TPF	Dimensions (mm)					Gage Dia.	C3	Uncoated	GP3	GP50	AC3	AC50
				T	E	A	B								
FLDC-3-8RDR75	553632R	8	3/4	4.95	3.18	8.74	10.19	9.53				●	●	●	●
FLDC-3-8RDL75	553632L	8	3/4	4.95	3.18	8.74	10.19	9.53				●	●	●	●
FLDC-3-10RDR75	553634R	10	3/4	4.95	3.18	8.74	10.19	9.53				●	●	●	●
FLDC-3-10RDL75	553634L	10	3/4	4.95	3.18	8.74	10.19	9.53				●	●	●	●

In an effort to improve our stock standard grade offering, there are periodic changes. Please see current price list for up to date grade offering.

- High performance choice in optimal conditions.
- ▲ Recommended grade under general conditions.

Cast Iron					
Non-Ferrous					
Stainless/High Temp					
Steel				▲	



FLO-LOCK

API Round Threading with Chipbreaker

■ For holders and bars see pgs. 101-104

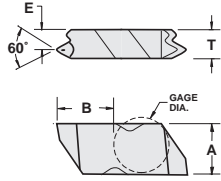

RH Shown

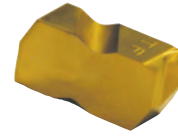

Description	EDP Code	TPI	TPF	Dimensions (mm)					Gage Dia.					
				T	E	A	B	C3		GP3	GP50	AC3	AC50	
FLDC-3-8RDR75-CB	553632PR	8	3/4	4.95	3.18	8.74	10.19	9.53						
FLDC-3-8RDL75-CB	553632PL	8	3/4	4.95	3.18	8.74	10.19	9.53		●	●	●	●	●

API Round Threading Multi-Tooth

■ For holders and bars see pgs. 101-104

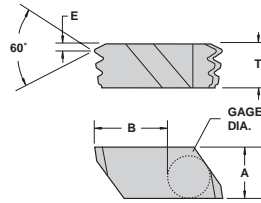

RH Shown



Description	EDP Code	TPI	TPF	Dimensions (mm)					Gage Dia.					
				T	E	A	B	C3		GP3	GP50	AC3	AC50	
FLDC-6-8RDR-75M	556632R	8	3/4	1.78	9.73	11.51	16.15	9.53						
FLDC-6-10RDR-75M	556634R	10	3/4	4.67	9.73	11.51	16.15	9.53		●	●	●	●	●

NPT Threading

■ For holders and bars see pgs. 101-104

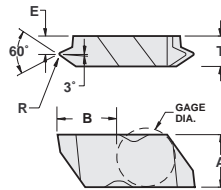

RH Shown

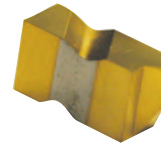

Description	EDP Code	TPI	TPF	Dimensions (mm)					Gage Dia.					
				T	E	A	B	C3		GP3	GP50	AC3	AC50	
FLDC-38VR-75	553608R	8	3/4	4.95	2.54	8.74	10.16	9.53		●	●	●	●	●
FLDC-38VL-75	553608L	8	3/4	4.95	2.54	8.74	10.16	9.53		●	●	●	●	●
FLDC-3115VR-75	553611R	11.5	3/4	4.95	3.66	8.74	10.16	9.53		●	●	●	●	●
FLDC-3115VL-75	553611L	11.5	3/4	4.95	3.66	8.74	10.16	9.53		●	●	●	●	●
FLDC-314VR-75	553614R	14	3/4	4.95	3.76	8.74	10.22	9.53		●	●	●	●	●
FLDC-314VL-75	553614L	14	3/4	4.95	3.76	8.74	10.22	9.53		●	●	●	●	●
FLDC-318VR-75	553618R	18	3/4	4.95	3.91	8.74	10.22	9.53		●	●	●	●	●
FLDC-318VL-75	553618L	18	3/4	4.95	3.91	8.74	10.22	9.53		●	●	●	●	●
FLDC-327VR-75	553627R	27	3/4	4.95	4.11	8.74	10.22	9.53		●	●	●	●	●
FLDC-327VL-75	553627L	27	3/4	4.95	4.11	8.74	10.22	9.53		●	●	●	●	●

NPT Threading Multi-Tooth

■ For holders and bars see pgs. 101-104

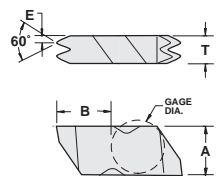

RH Shown



Description	EDP Code	TPI	TPF	Dimensions (mm)					Gage Dia.					
				T	E	A	B	C3		GP3	GP50	AC3	AC50	
FLDC-3-8 NPT-2E	553708E	8	3/4	6.35	1.47	8.74	10.29	9.53			●	●	●	●
FLDC-3-8 NPT-2I	553708I	8	3/4	6.35	1.47	8.74	10.29	9.53			●	●	●	●
FLDC-3-11.5 NPT-2E	553711E	11.5	3/4	6.35	1.22	8.74	10.29	9.53			●	●	●	●
FLDC-3-11.5 NPT-2I	553711I	11.5	3/4	6.35	1.22	8.74	10.29	9.53			●	●	●	●

In an effort to improve our stock standard grade offering, there are periodic changes. Please see current price list for up to date grade offering.

- High performance choice in optimal conditions.
- ▲ Recommended grade under general conditions.

Cast Iron		▲		●	
Non-Ferrous		▲		●	
Stainless/High Temp				●	
Steel			▲		



LAYDOWN-LT

API Buttress Threading

■ For holders and bars see pgs. 121-122

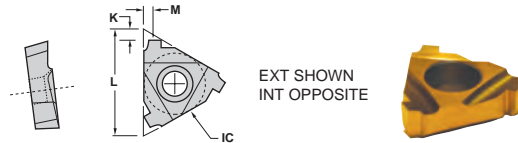

Description	EDP Code	TPI	TPF	IC	Dimensions (mm)			Connection	Coating					
					L	M	K		C22	GP22	GP50	AC22	AC50	
22ER 8B75	5102100	8	3/4	1/2	22.10	2.59	1.85	U.S. Improved Buttress		●	●	●	●	●
22ER 5B75	5101600	5	3/4	1/2	22.10	2.21	2.21	4-1/2 - 13-3/8		●	●	●	●	●
22ER 5B1	5101700	5	1	1/2	22.10	2.41	2.21	16 and larger		●	●	●	●	●
22NR 8B75	5122100	8	3/4	1/2	22.10	2.59	1.85	U.S. Improved Buttress			●	●	●	●
22NR 5B75	5121600	5	3/4	1/2	22.10	2.21	2.21	4-1/2 - 13-3/8			●	●	●	●
22NR 5B1	5121700	5	1	1/2	22.10	2.41	2.29	16 and larger			●	●	●	●

NPT Threading with Chipbreaker

Exclusive patented design!

■ For holders and bars see pgs. 121-122

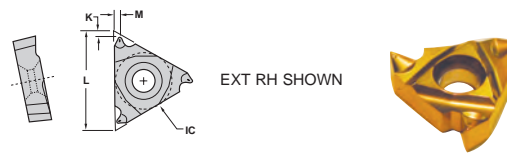

Description	EDP Code	TPI	IC	Dimensions (mm)			Coating				
				L	M	K	C22	GP22	GP50	AC22	AC50
16ER 27NPT-CB	5003627P	27	3/8	16.51	0.76	0.51	●	●	●	●	●
16ER 18NPT-CB	5003618P	18	3/8	16.51	0.76	0.51	●	●	●	●	●
16ER 14NPT-CB	5003614P	14	3/8	16.51	1.52	1.02	●	●	●	●	●
16ER 11.5NPT-CB	5003611P	11.5	3/8	16.51	1.52	1.02	●	●	●	●	●
16ER 8NPT-CB	5003608P	8	3/8	16.51	1.52	1.02	●	●	●	●	●
16NR 27NPT-CB	5023627P	27	3/8	16.51	0.76	0.51	●	●	●	●	●
16NR 18NPT-CB	5023618P	18	3/8	16.51	0.76	0.51	●	●	●	●	●
16NR 14NPT-CB	5023614P	14	3/8	16.51	1.52	1.02	●	●	●	●	●
16NR 11.5NPT-CB	5023611P	11.5	3/8	16.51	1.52	1.02	●	●	●	●	●
16NR 8NPT-CB	5023608P	8	3/8	16.51	1.52	1.02	●	●	●	●	●

NPT Threading

■ For holders and bars see pgs. 121-122

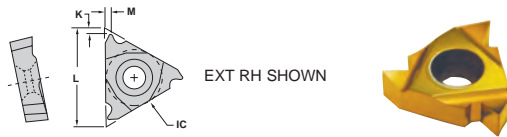

Description	EDP Code	TPI	IC	Dimensions (mm)			Coating				
				L	M	K	C22	GP22	GP50	AC22	AC50
16ER 27NPT	5003627	27	3/8	16.51	0.76	0.76	●	●	●	●	●
16EL 27NPT	5043627	27	3/8	16.51	0.76	0.76	●	●	●	●	●
16ER 18NPT	5003618	18	3/8	16.51	0.76	0.76	●	●	●	●	●
16EL 18NPT	5043618	18	3/8	16.51	0.76	0.76	●	●	●	●	●
16ER 14NPT	5003614	14	3/8	16.51	1.27	1.02	●	●	●	●	●
16EL 14NPT	5043614	14	3/8	16.51	1.27	1.02	●	●	●	●	●
16ER 11.5NPT	5003611	11.5	3/8	16.51	1.52	1.02	●	●	●	●	●
16EL 11.5NPT	5043611	11.5	3/8	16.51	1.52	1.02	●	●	●	●	●
16ER 8NPT	5003608	8	3/8	16.51	1.78	1.27	●	●	●	●	●
16EL 8NPT	5043608	8	3/8	16.51	1.78	1.27	●	●	●	●	●
11NR 18NPT	4923618	18	1/4	10.92	1.02	0.76	●	●	●	●	●
11NR 27NPT	4923627	27	1/4	10.92	1.02	0.76	●	●	●	●	●
16NR 27NPT	5023627	27	3/8	16.51	0.76	0.76	●	●	●	●	●
16NL 27NPT	5063627	27	3/8	16.51	0.76	0.76	●	●	●	●	●
16NR 18NPT	5023618	18	3/8	16.51	1.02	0.76	●	●	●	●	●
16NL 18NPT	5063618	18	3/8	16.51	1.02	0.76	●	●	●	●	●
16NR 14NPT	5023614	14	3/8	16.51	1.27	1.02	●	●	●	●	●
16NL 14NPT	5063614	14	3/8	16.51	1.27	1.02	●	●	●	●	●
16NR 11.5NPT	5023611	11.5	3/8	16.51	1.52	1.02	●	●	●	●	●
16NL 11.5NPT	5063611	11.5	3/8	16.51	1.52	1.02	●	●	●	●	●
16NR 8NPT	5023608	8	3/8	16.51	1.52	1.27	●	●	●	●	●
16NL 8NPT	5063608	8	3/8	16.51	1.52	1.27	●	●	●	●	●

In an effort to improve our stock standard grade offering, there are periodic changes. Please see current price list for up to date grade offering.

● High performance choice in optimal conditions.
▲ Recommended grade under general conditions.

Material	GP22	GP50	AC22	AC50
Cast Iron	▲	●	●	●
Non-Ferrous	▲	●	●	●
Stainless/High Temp	▲	●	●	●
Steel	●	▲	●	●



LAYDOWN-LT

NPT Threading Multi-Tooth

■ For holders and bars see pgs. 121-122

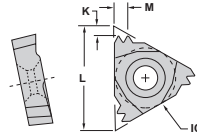

EXT RH SHOWN

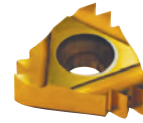

TIN Coated		AlTiN Coated			
GP22	GP25	GP50	GP54	AC22	AC50
●	●	●	●	●	●
●	●	●	●	●	●
●	●	●	●	●	●
●	●	●	●	●	●
●	●	●	●	●	●
●	●	●	●	●	●

Description	EDP Code	No of Teeth	TPI	IC	Dimensions (mm)			GP22	GP25	GP50	GP54	AC22	AC50
					L	M	K						
22ER 11.5NPT2M	5103811	2	11.5	1/2	22.10	3.30	2.29	●	●	●	●	●	●
27ER 11.5NPT3M	5203811	3	11.5	5/8	27.43	5.59	3.56	●	●	●	●	●	●
27ER 8NPT2M	5203808	2	8	5/8	27.43	4.83	2.79	●	●	●	●	●	●
22NR 11.5NPT2M	5123811	2	11.5	1/2	22.10	3.30	2.29	●	●	●	●	●	●
27NR 11.5NPT3M	5223811	3	11.5	5/8	27.43	5.59	3.56	●	●	●	●	●	●
27NR 8NPT2M	5223808	2	8	5/8	27.43	4.83	2.79	●	●	●	●	●	●

NPTF Threading Chipbreaker

For Dry Seal listing see page

Exclusive patented design!

■ For holders and bars see pgs. 121-122

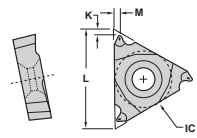

EXT RH SHOWN



Description	EDP Code	TPI	IC	Dimensions (mm)			C22	GP22	GP50	AC22	AC50
				L	M	K					
16ER 27NPTF-CB	5004027P	27	3/8	16.51	0.76	0.76	●	●	●	●	●
16ER 18NPTF-CB	5004018P	18	3/8	16.51	1.02	0.76	●	●	●	●	●
16ER 14NPTF-CB	5004014P	14	3/8	16.51	1.27	1.02	●	●	●	●	●
16ER 11.5NPTF-CB	5004011P	11.5	3/8	16.51	1.52	1.02	●	●	●	●	●
16ER 8NPTF-CB	5004008P	8	3/8	16.51	1.78	1.27	●	●	●	●	●
16NR 27NPTF--CB	5024027P	27	3/8	16.51	0.76	0.76	●	●	●	●	●
16NR 18NPTF-CB	5024018P	18	3/8	16.51	0.76	0.51	●	●	●	●	●
16NR 14NPTF-CB	5024014P	14	3/8	16.51	1.52	1.02	●	●	●	●	●
16NR 11.5NPTF-CB	5024011P	11.5	3/8	16.51	1.52	1.02	●	●	●	●	●
16NR 8NPTF-CB	5024008P	8	3/8	16.51	1.52	1.02	●	●	●	●	●

NPTF Threading

■ For holders and bars see pgs. 121-122

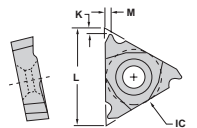

EXT RH SHOWN



Description	EDP Code	TPI	IC	Dimensions (mm)			C22	GP22	GP50	AC22	AC50
				L	M	K					
16ER 27NPTF	5004027	27	3/8	16.51	0.76	0.76	●	●	●	●	●
16EL 27NPTF	5044027	27	3/8	16.51	0.76	0.76	●	●	●	●	●
16ER 18NPTF	5004018	18	3/8	16.51	1.02	0.76	●	●	●	●	●
16EL 18NPTF	5044018	18	3/8	16.51	1.02	0.76	●	●	●	●	●
16ER 14NPTF	5004014	14	3/8	16.51	1.27	1.02	●	●	●	●	●
16EL 14NPTF	5044014	14	3/8	16.51	1.27	1.02	●	●	●	●	●
16ER 11.5NPTF	5004011	11.5	3/8	16.51	1.52	1.02	●	●	●	●	●
16EL 11.5NPTF	5044011	11.5	3/8	16.51	1.52	1.02	●	●	●	●	●
16ER 8NPTF	5004008	8	3/8	16.51	1.78	1.27	●	●	●	●	●
16EL 8NPTF	5044008	8	3/8	16.51	1.78	1.27	●	●	●	●	●
11NR 27NPTF	4923827	27	1/4	10.92	0.76	0.76	●	●	●	●	●
11NR 18NPTF	4924018	18	1/4	10.92	1.02	0.76	●	●	●	●	●
16NR 27NPTF	5024027	27	3/8	16.51	0.76	0.76	●	●	●	●	●
16NL 27NPTF	5064027	27	3/8	16.51	0.76	0.76	●	●	●	●	●
16NR 18NPTF	5024018	18	3/8	16.51	1.02	0.76	●	●	●	●	●
16NL 18NPTF	5064018	18	3/8	16.51	1.02	0.76	●	●	●	●	●
16NR 14NPTF	5024014	14	3/8	16.51	1.27	1.02	●	●	●	●	●
16NL 14NPTF	5064014	14	3/8	16.51	1.27	1.02	●	●	●	●	●
16NR 11.5NPTF	5024011	11.5	3/8	16.51	1.52	1.02	●	●	●	●	●
16NL 11.5NPTF	5064011	11.5	3/8	16.51	1.52	1.02	●	●	●	●	●
16NR 8NPTF	5024008	8	3/8	16.51	1.78	1.27	●	●	●	●	●
16NL 8NPTF	5064008	8	3/8	16.51	1.78	1.27	●	●	●	●	●

In an effort to improve our stock standard grade offering, there are periodic changes. Please see current price list for up to date grade offering.

- High performance choice in optimal conditions.
- ▲ Recommended grade under general conditions.

Cast Iron	▲	●
Non-Ferrous	▲	●
Stainless/High Temp	▲	●
Steel	▲	●



LAYDOWN-LT

API Rotary Shoulder Connection Threading

■ For holders and bars see pgs. 121-122

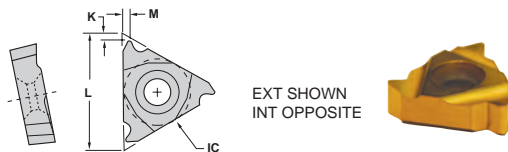

Description	EDP Code	TPI	TPF	IC	Dimensions (mm)			Connection	Coating					
					L	M	K		C22	GP22	GP50	AC22	AC50	
22ER 530	5101300	5	3	1/2	22.10	2.54	2.03	3-1/2FH, 2-3/8, 4-1/2 Reg.						
22ER 4PAC	5101500	4	1-1/2	1/2	22.10	2.79	2.03	American Open Hole						
22ER 438	5101200	4	3	1/2	22.10	2.79	2.79	NC56 - NC71						
22ER 435	5101100	4	3	1/2	22.10	2.79	2.03	5-1/2, 7-5/8, 8-5/8 Reg.						
22ER 42F	5101400	4	2	1/2	22.10	2.79	2.03	VO.065*						
22ER 428	5101000	4	2	1/2	22.10	2.54	2.03	NC23-NC50, 2-3/8 - 5-1/2IF						
22ER 425	5100900	4	2	1/2	22.10	2.54	2.03	5-1/2, 6-5/8FH, 6-5/8 Reg.						
22NR 530	5121300	5	3	1/2	22.10	2.54	2.03	3-1/2FH, 2-3/8, 4-1/2 Reg.						
22NR 4PAC	5121500	4	1-1/2	1/2	22.10	2.79	2.03	American Open Hole						
22NR 438	5121200	4	3	1/2	22.10	2.79	2.79	NC56 - NC71						
22NR 435	5121100	4	3	1/2	22.10	2.79	2.03	5-1/2, 7-5/8, 8-5/8 Reg.						
22NR 42F	5121400	4	2	1/2	22.10	2.79	2.03	VO.065*						
22NR 428	5121000	4	2	1/2	22.10	2.54	2.03	NC23-NC50, 2-3/8 - 5-1/2IF						
22NR 425	5120900	4	2	1/2	22.10	2.54	2.03	5-1/2, 6-5/8FH, 6-5/8 Reg.						
27ER 530	5201300	5	3	5/8	27.43	2.79	1.78	3-1/2FH, 2-3/8, 4-1/2 Reg.						
27ER 438	5201200	4	3	5/8	27.43	2.79	2.03	NC56 - NC71						
27ER 435	5201100	4	3	5/8	27.43	3.05	2.03	5-1/2, 7-5/8, 8-5/8 Reg.						
27ER 428	5201000	4	2	5/8	27.43	2.79	2.03	NC23-NC50, 2-3/8 - 5-1/2IF						
27ER 425	5200900	4	2	5/8	27.43	3.05	2.03	5-1/2, 6-5/8FH, 6-5/8 Reg.						
27NR 530	5221300	5	3	5/8	27.43	2.79	2.03	3-1/2FH, 2-3/8, 4-1/2 Reg.						
27NR 438	5221200	4	3	5/8	27.43	2.79	2.03	NC56 - NC71						
27NR 435	5221100	4	3	5/8	27.43	3.05	2.03	5-1/2, 7-5/8, 8-5/8 Reg.						
27NR 428	5221000	4	2	5/8	27.43	2.79	2.03	NC23-NC50, 2-3/8 - 5-1/2IF						
27NR 425	5220900	4	2	5/8	27.43	3.05	2.03	5-1/2, 6-5/8FH, 6-5/8 Reg.						

* Obsolete thread form, See A.P.I. Spec 7, 35th Edition, May 1, 1995, Section 9.4

API Round Threading Chipbreaker

■ For holders and bars see pgs. 121-122

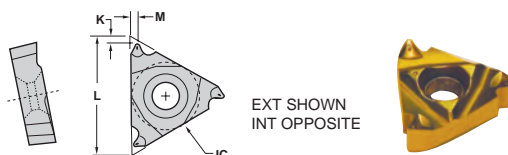

Description	EDP Code	TPI	IC	Dimensions (mm)			Coating					
				L	M	K	GP22	GP50	AC22	AC50		
16ER 8RD-CB	5003200HC	8	3/8	16.51	1.30	1.50						
16ER 10RD-CB	5003400HC	10	3/8	16.51	1.19	1.50						
16NR 8RD-CB	5023200HC	8	3/8	16.51	1.30	1.50						
16NR 10RD-CB	5023400HC	10	3/8	16.51	1.19	1.50						

API Round Threading

■ For holders and bars see pgs. 121-122

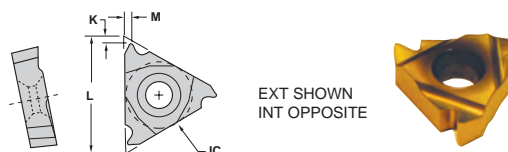

Description	EDP Code	TPI	TPF	IC	Dimensions (mm)			Coating						
					L	M	K	C22	GP22	GP50	AC22	AC50		
16ER 8RD	5003200	8	3/4	3/8	16.51	1.50	1.42							
16ER 10RD	5003400	10	3/4	3/8	16.51	1.50	1.42							
22ER 8RD	5103200	8	3/4	1/2	22.10	1.52	1.42							
22ER 10RD	5103400	10	3/4	1/2	22.10	1.17	1.22							
16NR 8RD	5023200	8	3/4	3/8	16.51	1.50	1.42							
16NR 10RD	5023400	10	3/4	3/8	16.51	1.50	1.42							
22NR 8RD	5123200	8	3/4	1/2	22.10	1.52	1.42							
22NR 10RD	5123400	10	3/4	1/2	22.10	1.17	1.22							

In an effort to improve our stock standard grade offering, there are periodic changes. Please see current price list for up to date grade offering.

- High performance choice in optimal conditions.
- ▲ Recommended grade under general conditions.

	Cast Iron	Non-Ferrous	Stainless/High Temp	Steel
▲				
▲				
▲				
▲				



LAYDOWN-LT

API Round Threading Multi-Tooth

■ For holders and bars see pgs. 121-122

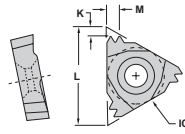

EXT SHOWN
INT OPPOSITE



Description	EDP Code	TPI	IC	Dimensions (mm)			C22	GP22	GP50	AC22	AC50
				L	M	K					
22ER 10RD2M	5103500	10	1/2	22.10	3.71	2.39				●	●
27ER 8RD2M	5203300	8	5/8	27.43	4.50	2.90				●	●
22NR 10RD2M	5123500	10	1/2	22.10	3.71	2.39				●	●
27NR 8RD2M	5223300	8	5/8	27.43	4.50	2.90				●	●

API VO.055

American MT, AMT & AMMT*

■ For holders and bars see pgs. 121-122

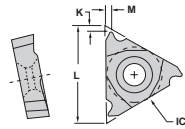

EXT SHOWN
INT OPPOSITE



Description	EDP Code	TPI	TPF	IC	Dimensions (mm)			Connection	C22	GP22	GP50	AC22	AC50
					L	M	K						
16ER 6P VO.055 MT	5004300	6	1-1/2	3/8	16.51	1.50	1.30	NC10-NC16, VO.055, 1, 1-1/2 REG		●	●	●	
22ER 6P VO.055 MT	5104300	6	1-1/2	1/2	22.10	1.83	1.52	NC10-NC16, VO.055, 1, 1-1/2 REG		●	●	●	
16NR 6P VO.055 MT	5024300	6	1-1/2	3/8	16.51	1.50	1.30	NC10-NC16, VO.055, 1, 1-1/2 REG		●	●	●	
22NR 6P VO.055 MT	5124300	6	1-1/2	1/2	22.10	1.83	1.52	NC10-NC16, VO.055, 1, 1-1/2 REG		●	●	●	

* MT is Macaroni Tubing, AMT is American Macaroni Tubing and AMMT is American Mining Macaroni Tubing.

API VAM Threading

■ For holders and bars see pgs. 121-122

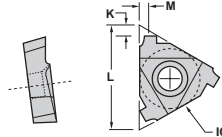

EXT SHOWN
INT OPPOSITE



Description	EDP Code	TPI	IC	Dimensions (mm)			C22	GP22	GP50	AC22	AC50
				L	M	K					
22ER 8VAM	5102500	8	1/2	22.10	1.50	1.50			●		
22ER 6VAM	5102400	6	1/2	22.10	2.01	2.01			●	●	
22ER 5VAM	5102300	5	1/2	22.10	2.01	2.01			●		
22NR 8VAM	5122500	8	1/2	22.10	1.50	1.50			●		
22NR 6VAM	5122400	6	1/2	22.10	2.01	2.01			●	●	
22NR 5VAM	5122300	5	1/2	22.10	2.01	2.01			●		

API X-Line Threading

■ For holders and bars see pgs. 121-122

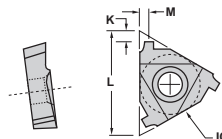

EXT RH SHOWN

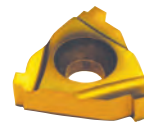

Description	EDP Code	TPI	TPF	IC	Dimensions (mm)			Connection	C22	GP22	GP50	AC22	AC50
					L	M	K						
22ER 6XL75	5102000	6	3/4	1/2	22.10	1.91	1.98			●			
22ER 6XL15	5101900	6	1-1/2	1/2	22.10	1.91	2.18	5 - 7-5/8		●			
22ER 5XL12	5101800	5	1-1/4	1/2	22.10	2.21	2.11	8-5/8 - 10-3/4		●			
22NR 6XL75	5122000	6	3/4	1/2	22.10	1.91	1.98			●			
22NR 6XL15	5121900	6	1-1/2	1/2	22.10	1.91	2.18	5 - 7-5/8		●			
22NR 5XL12	5121800	5	1-1/4	1/2	22.10	2.21	2.11	8-5/8 - 10-3/4		●			

In an effort to improve our stock standard grade offering, there are periodic changes. Please see current price list for up to date grade offering.

- High performance choice in optimal conditions.
- ▲ Recommended grade under general conditions.

Cast Iron				●
Non-Ferrous				
Stainless/High Temp				●
Steel			▲	●



LAYDOWN

API Buttress Threading

■ For holders and bars see pgs. 132-134

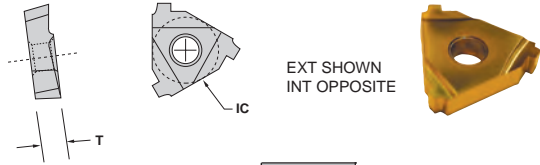

Description	EDP Code	TPI	TPF	IC	(mm)		Connection	Coatings					
					T			C6H	GP50	GP54	AC50	AC54	
L43 5B75 EXT-FC	16154F	5	3/4	1/2	4.80		4-1/2 - 13-3/8	●	●	●	●	●	
L43 5B1 EXT-FC	17514F	5	1	1/2	4.80		16 and larger	●	●	●	●	●	
L43 8B75 EXT-FC	21154F	8	3/4	1/2	4.80		US Improved Buttress	●	●	●	●	●	
L53 5B75 EXT-FC	16474F	5	3/4	5/8	4.80		4-1/2 - 13-3/8	●	●	●	●	●	
L53 5B1 EXT-FC	17474F	5	1	5/8	4.80		16 and larger	●	●	●	●	●	
L53 8B75 EXT-FC	21474F	8	3/4	5/8	4.80		US Improved Buttress	●	●	●	●	●	
L43 5B75 INT-FC	16158F	5	3/4	1/2	4.80		4-1/2 - 13-3/8	●	●	●	●	●	
L43 5B1 INT-FC	17518F	5	1	1/2	4.80		16 and larger	●	●	●	●	●	
L43 8B75 INT-FC	21158F	8	3/4	1/2	4.80		US Improved Buttress	●	●	●	●	●	
L53 5B75 INT-FC	16478F	5	3/4	5/8	4.80		4-1/2 - 13-3/8	●	●	●	●	●	
L53 5B1 INT-FC	17478F	5	1	5/8	4.80		16 and larger	●	●	●	●	●	
L53 8B75 INT-FC	21478F	8	3/4	5/8	4.80		US Improved Buttress	●	●	●	●	●	

FC designates 5° flank clearance

API Hughes H90 Threading

■ For holders and bars see pgs. 132-134

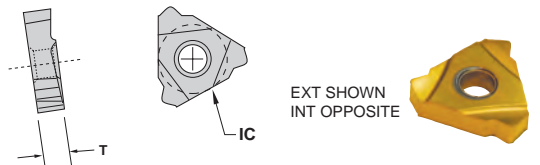

Description	EDP Code	TPI	TPF	IC	(mm)		Connection	Coatings					
					T			C6H	GP50	GP54	AC50	AC54	
L53 H902 EXT	28474	3-1/2	2	5/8	4.80		3-1/2 - 6-5/8 H90	●	●	●	●	●	
L53 H903 EXT	29474	3-1/2	3	5/8	4.80		7 - 8-5/8 H90	●	●	●	●	●	
L53 H90S EXT	27474	3	1-1/4	5/8	4.80		2-3/8 - 3-1/2 Slimline	●	●	●	●	●	
L53 H902 INT	28478	3-1/2	2	5/8	4.80		3-1/2 - 6-5/8 H90	●	●	●	●	●	
L53 H903 INT	29478	3-1/2	3	5/8	4.80		7 - 8-5/8 H90	●	●	●	●	●	
L53 H90S INT	27478	3	1-1/4	5/8	4.80		2-3/8 - 3-1/2 Slimline	●	●	●	●	●	

API Hughes H90 Threading

LDS Double Sided Internal/External

■ For holders and bars see pgs. 132-134

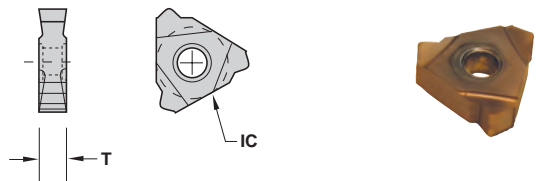

Description	EDP Code	TPI	TPF	IC	(mm)		Connection	Coatings					
					T			C6H	GP50	GP54	AC50	AC54	
LDS 54 H902	28490	3-1/2	2	5/8	6.40		3-1/2 - 6-5/8 H90	●	●	●	●	●	
LDS 54 H903	29490	3-1/2	3	5/8	6.40		7 - 8-5/8 H90	●	●	●	●	●	
LDS 54 H90S	27490	3	1-1/4	5/8	6.40		2-3/8 - 3-1/2 Slimline	●	●	●	●	●	

NPT Threading

■ For holders and bars see pgs. 132-134

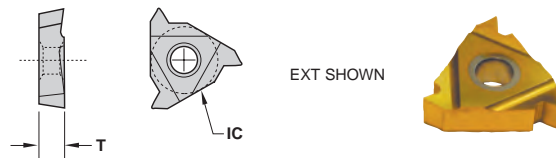

Description	EDP Code	TPI	TPF	IC	Dimensions (mm)		Connection	Coatings					
					T			C22	GP22	GP50	AC22	AC50	
L43 8NPT EXT	3615084	8	3/4	1/2	4.80			●	●	●	●	●	
L43 11.5NPT EXT	3615114	11.5	3/4	1/2	4.80			●	●	●	●	●	
L43 8NPT INT	3615088	8	3/4	1/2	4.80			●	●	●	●	●	
L43 11.5NPT INT	3615118	11.5	3/4	1/2	4.80			●	●	●	●	●	

In an effort to improve our stock standard grade offering, there are periodic changes. Please see current price list for up to date grade offering.

● High performance choice in optimal conditions.
▲ Recommended grade under general conditions.

Material	▲	●
Cast Iron		●
Non-Ferrous	▲	●
Stainless/High Temp	▲	●
Steel	▲	●



LAYDOWN-LT

NPT Threading Multi-Tooth

■ For holders and bars see pgs. 132-134

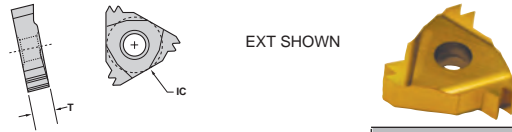

Description	EDP Code	TPI	TPF	IC	Dimensions (mm)		Coatings						
					T		C22	GP22	GP50	AC22	AC50		
L43 11.5NPT2M EXT	3615114T	11.5	3/4	1/2	4.80					●	●		
L43 11.5NPT2M INT	3615118T	11.5	3/4	1/2	4.80			●	●	●	●	●	●

NPT Threading LDS Double Sided Internal/External

■ For holders and bars see pgs. 132-134

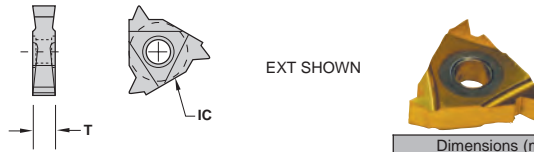

Description	EDP Code	TPI	TPF	IC	Dimensions (mm)		Coatings					
					T		C22	GP22	GP50	GP54	AC22	
LDS 43 8NPT	361808	8	3/4	1/2	4.80					●		
LDS 43 11.5NPT	361811	11.5	3/4	1/2	4.80					●		
LDS 43 14NPT	361814	14	3/4	1/2	4.80					●		

Pittsburg Acme Threading

■ For holders and bars see pgs. 132-134

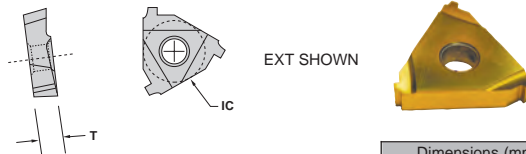

Description	EDP Code	TPI	TPF	IC	Dimensions (mm)		Coatings					
					T		C22	GP22	GP50	GP54	AC22	
L43 8PA75 EXT	22154	8	3/4	1/2	4.80							
L53 8PA75 EXT	22474	8	3/4	5/8	4.80				●			
L43 8PA75 INT	22158	8	3/4	1/2	4.80				●			
L53 8PA75 INT	22478	8	3/4	5/8	4.80				●			

API Rotary Shoulder Connection Threading

■ For holders and bars see pgs. 132-134

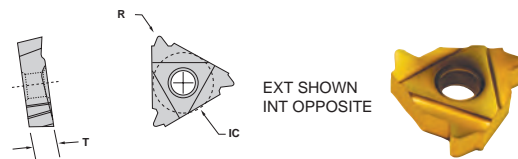

Description	EDP Code	TPI	TPF	IC	Dimensions (mm)		Connection	Coatings				
					R	T		GP50	GP54	AC22	AC50	AC54
L43 425 EXT	09154	4	2	1/2	0.64	4.80	5-1/2 FH 6-5/8 FH 6-5/8 Reg.	●		●	●	
L43 428 EXT	10154	4	2	1/2	0.97	4.80	NC 23-NC50 2-3/8 - 5-1/2 IF	●		●	●	
L43 42F EXT*	14154	4	2	1/2	---	4.80	V0.065*					
L43 435 EXT	11154	4	3	1/2	0.64	4.80	5-1/2 Rg. 7-5/8 Reg. 8-5/8 Reg.	●		●	●	
L43 438 EXT	12154	4	3	1/2	0.97	4.80	NC56 - NC71	●		●	●	
L43 530 EXT	13154	5	3	1/2	0.51	4.80	3-1/2 FH 2-3/8 - 4-1/2 Reg.	●		●	●	
L43 4PAC EXT	15154	4	1-1/2	1/2	---	4.80	American Open Hole	●				
L53 425 EXT	09474	4	2	5/8	0.64	4.80	5-1/2 FH 6-5/8 FH 6-5/8 Reg.	●		●	●	
L53 428 EXT	10474	4	2	5/8	0.97	4.80	NC 23-NC50 2-3/8 - 5-1/2 IF	●		●	●	
L53 42F EXT*	14474	4	2	5/8	---	4.80	V0.065*					
L53 435 EXT	11474	4	3	5/8	0.64	4.80	5-1/2 Rg. 7-5/8 Reg. 8-5/8 Reg.	●		●	●	
L53 438 EXT	12474	4	3	5/8	0.97	4.80	NC56 - NC71	●		●	●	
L53 530 EXT	13474	5	3	5/8	0.51	4.80	3-1/2 FH 2-3/8 - 4-1/2 Reg.	●		●	●	
L53 4PAC EXT	15474	4	1-1/2	5/8	---	4.80	American Open Hole	●				
L43 425 INT	09158	4	2	1/2	0.64	4.80	5-1/2 FH 6-5/8 FH 6-5/8 Reg.	●		●	●	
L43 428 INT	10158	4	2	1/2	0.97	4.80	NC 23-NC50 2-3/8 - 5-1/2 IF	●		●	●	
L43 42F INT*	14158	4	2	1/2	---	4.80	V0.065*					
L43 435 INT	11158	4	3	1/2	0.64	4.80	5-1/2 Rg. 7-5/8 Reg. 8-5/8 Reg.	●		●	●	
L43 438 INT	12158	4	3	1/2	0.97	4.80	NC56 - NC71	●		●	●	
L43 530 INT	13158	5	3	1/2	0.51	4.80	3-1/2 FH 2-3/8 - 4-1/2 Reg.	●		●	●	
L43 4PAC INT	15158	4	1-1/2	1/2	---	4.80	American Open Hole	●				
L53 425 INT	09478	4	2	5/8	0.64	4.80	5-1/2 FH 6-5/8 FH 6-5/8 Reg.	●		●	●	
L53 428 INT	10478	4	2	5/8	0.97	4.80	NC 23-NC50 2-3/8 - 5-1/2 IF	●		●	●	
L53 42F INT*	14478	4	2	5/8	---	4.80	V0.065*					
L53 435 INT	11478	4	3	5/8	0.64	4.80	5-1/2 Rg. 7-5/8 Reg. 8-5/8 Reg.	●		●	●	
L53 438 INT	12478	4	3	5/8	0.97	4.80	NC56 - NC71	●		●	●	
L53 530 INT	13478	5	3	5/8	0.51	4.80	3-1/2 FH 2-3/8 - 4-1/2 Reg.	●		●	●	
L53 4PAC INT	15478	4	1-1/2	5/8	---	4.80	American Open Hole	●				

* Obsolete thread form. See A.P.I. Spec 7, 35th Edition, May 1, 1995, Section 9.4

In an effort to improve our stock standard grade offering, there are periodic changes. Please see current price list for up to date grade offering.

- High performance choice in optimal conditions.
- ▲ Recommended grade under general conditions.

Material	GP50	GP54	AC22	AC50	AC54
Cast Iron					●
Non-Ferrous					●
Stainless/High Temp					●
Steel			▲	▲	



LAYDOWN

API Rotary Shoulder Connection Threading

LDS Double Sided
Lead Follow Topping
Internal/External
with patented chipbreaker

Exclusive patented design!

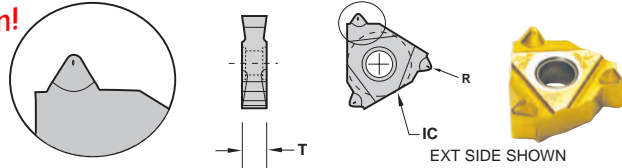

Uncoated	TIN Coated		AITIN Coated	
	GP54	AC22	AC50	AC54
●	●	●	●	●
●	●	●	●	●
●	●	●	●	●
●	●	●	●	●

■ For holders and bars see pgs. 132-134

Description	EDP Code	TPI	TPF	IC	Dimensions (mm)		Connection	C6H	GP54	AC22	AC50	AC54
					R	T						
LDS 54 428-CB #1	10490HC	4	2	5/8	0.97	6.40	NC23-NC50, 2-3/8-5-1/2 IF	●	●	●	●	●
LDS 54 438-CB #2	12490HC	4	3	5/8	0.97	6.40	NC56-NC71	●	●	●	●	●
LDS 54 425-CB #3	09490HC	4	2	5/8	0.64	6.40	5-1/2 FH, 6-5/8 FH, 6-5/8 Reg.	●	●	●	●	●
LDS 54 435-CB #4	11490HC	4	3	5/8	0.64	6.40	5-1/2 Reg. 7-5/8 Reg 8-5/8 Reg.	●	●	●	●	●
LDS 54 530-CB #5	13490HC	5	3	5/8	0.51	6.40	3-1/2 FH 2-3/8 - 4-1/2 Reg.	●	●	●	●	●

LDS Double Sided
Follow Topping
Internal/External
with patented chipbreaker

Exclusive patented design!

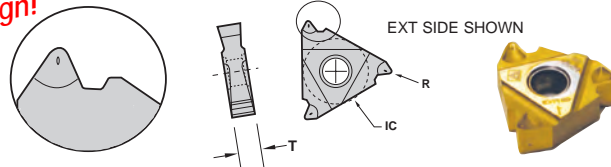

TIN Coated	AITIN Coated	
	GP50	AC54
●	●	●
●	●	●
●	●	●
●	●	●

■ For holders and bars see pgs. 132-134

Description	EDP Code	TPI	TPF	IC	Dimensions (mm)		Connection	GP50	GP54	AC22	AC50	AC54
					R	T						
LDS 54 428 FT-CB #1	10495HC	4	2	5/8	0.97	6.40	NC23-NC50, 2-3/8-5-1/2 IF	●	●	●	●	●
LDS 54 438 FT-CB #2	12495HC	4	3	5/8	0.97	6.40	NC56-NC71	●	●	●	●	●
LDS 54 425 FT-CB #3	09495HC	4	2	5/8	0.64	6.40	5-1/2 FH, 6-5/8 FH, 6-5/8 Reg.	●	●	●	●	●
LDS 54 435 FT-CB #4	11495HC	4	3	5/8	0.64	6.40	5-1/2 Reg. 7-5/8 Reg 8-5/8 Reg.	●	●	●	●	●
LDS 54 530 FT-CB #5	13495HC	5	3	5/8	0.51	6.40	3-1/2 FH 2-3/8 - 4-1/2 Reg.	●	●	●	●	●

API Rotary Shoulder Connection Threading

LDS Double Sided
Lead Follow Topping
Internal/External

■ For holders and bars see pgs. 132-134

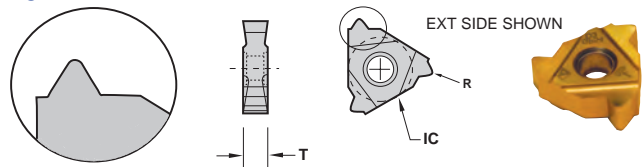

Uncoated	TIN Coated		AITIN Coated	
	GP54	AC22	AC50	AC54
●	●	●	●	●
●	●	●	●	●
●	●	●	●	●
●	●	●	●	●

Description	EDP Code	TPI	TPF	IC	Dimensions (mm)		Connection	C6H	GP54	AC22	AC50	AC54
					R	T						
LDS 54 428 #1	10490	4	2	5/8	0.97	6.40	NC23-NC50, 2-3/8-5-1/2 IF	●	●	●	●	●
LDS 54 438 #2	12490	4	3	5/8	0.97	6.40	NC56-NC71	●	●	●	●	●
LDS 54 425 #3	09490	4	2	5/8	0.64	6.40	5-1/2 FH, 6-5/8 FH, 6-5/8 Reg.	●	●	●	●	●
LDS 54 435 #4	11490	4	3	5/8	0.64	6.40	5-1/2 Reg. 7-5/8 Reg 8-5/8 Reg.	●	●	●	●	●
LDS 54 530 #5	13490	5	3	5/8	0.51	6.40	3-1/2 FH 2-3/8 - 4-1/2 Reg.	●	●	●	●	●
LDS 54 42F	14490	4	2	5/8	---	6.40	V0.065*	●	●	●	●	●
LDS 54 4PAC	15490	4	1-1/2	5/8	---	6.40	American Open Hole	●	●	●	●	●

* Obsolete thread form, See A.P.I. Spec 7, 35th Edition, May 1, 1995, Section 9.4

API Rotary Shoulder Connection Threading

LDS Double Sided
Follow Topping
Internal/External

■ For holders and bars see pgs. 132-134

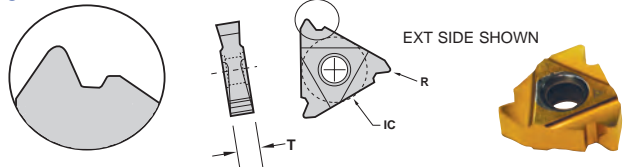

TIN Coated	AITIN Coated	
	GP50	AC54
●	●	●
●	●	●
●	●	●
●	●	●
●	●	●

Description	EDP Code	TPI	TPF	IC	Dimensions (mm)		Connection	GP50	GP54	AC22	AC50	AC54
					R	T						
LDS 54 428 #1-FT	10495	4	2	5/8	0.97	6.40	NC23-NC50, 2-3/8-5-1/2 IF	●	●	●	●	●
LDS 54 438 #2-FT	12495	4	3	5/8	0.97	6.40	NC56-NC71	●	●	●	●	●
LDS 54 425 #3-FT	09495	4	2	5/8	0.64	6.40	5-1/2 FH, 6-5/8 FH, 6-5/8 Reg.	●	●	●	●	●
LDS 54 435 #4-FT	11495	4	3	5/8	0.64	6.40	5-1/2 Reg. 7-5/8 Reg 8-5/8 Reg.	●	●	●	●	●
LDS 54 530 #5-FT	13495	5	3	5/8	0.51	6.40	3-1/2 FH 2-3/8 - 4-1/2 Reg.	●	●	●	●	●
LDS 54 42F-FT	11495	4	2	5/8	---	6.40	V0.065*	●	●	●	●	●
LDS 54 4PAC-FT	15495	4	1-1/2	5/8	---	6.40	American Open Hole	●	●	●	●	●

* Obsolete thread form - see API Spec 7, 35th Edition, May 1, 1985 Section 9.4.

In an effort to improve our stock standard grade offering there are periodic changes. Please see current price list for up to date grade offering.

- High performance choice in optimal conditions.
- ▲ Recommended grade under general conditions.

Cast Iron	●	●	●	●
Non-Ferrous	●	●	●	●
Stainless/High Temp	●	●	●	●
Steel	▲	▲	●	●



LAYDOWN

API Round Threading

■ For holders and bars see pgs. 132-134

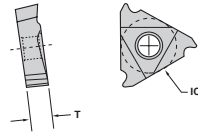

INT SHOWN

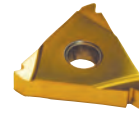

Description	EDP Code	TPI	TPF	IC	Dimensions (mm)					
					T					
L43 8RD EXT	32154	8	3/4	1/2	4.80	●	●	●	●	●
L43 10RD EXT	34154	10	3/4	1/2	4.80	●	●	●	●	●
L53 8RD EXT	32474	8	3/4	5/8	4.80	●	●	●	●	●
L43 8RD INT	32158	8	3/4	1/2	4.80	●	●	●	●	●
L43 10RD INT	34158	10	3/4	1/2	4.80	●	●	●	●	●
L53 8RD INT	32478	8	3/4	5/8	4.80	●	●	●	●	●

API Round Threading

LDS Double Sided Internal/External

■ For holders and bars see pgs. 132-134

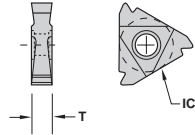

EXT SIDE SHOWN

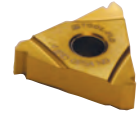

Description	EDP Code	TPI	TPF	IC	Dimensions (mm)					
					T					
LDS 43 8RD	32180	8	3/4	1/2	4.80	●	●	●	●	●
LDS 43 10RD	34180	10	3/4	1/2	4.80	●	●	●	●	●
LDS 54 8RD	32490	8	3/4	5/8	6.40	●	●	●	●	●
LDS 54 10RD	34490	10	3/4	5/8	6.40	●	●	●	●	●

API Round Threading

Double Sided Internal/External

■ For holders and bars see pgs. 132-134

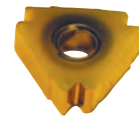
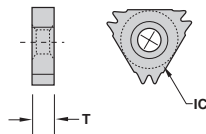

Description	EDP Code	TPI	TPF	IC	Dimensions (mm)					
					T					
TNFA 43 8RD	32N70	8	3/4	1/2	4.75	●	●	●	●	●

■ For holders and bars see pgs. 132-134

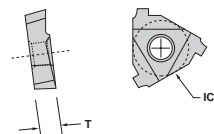

EXT SHOWN
INT OPPOSITE



Description	EDP Code	TPI	TPF	IC	Dimensions (mm)					
					T					
L43 5VAM EXT	23154	5	3/4	1/2	4.80	●	●	●	●	●
L43 6VAM EXT	24154	6	3/4	1/2	4.80	●	●	●	●	●
L43 8VAM EXT	25154	8	3/4	1/2	4.80	●	●	●	●	●
L43 5VAM INT	23158	5	3/4	1/2	4.80	●	●	●	●	●
L43 6VAM INT	24158	6	3/4	1/2	4.80	●	●	●	●	●
L43 8VAM INT	25158	8	3/4	1/2	4.80	●	●	●	●	●

API X-Line Threading

■ For holders and bars see pgs. 132-134

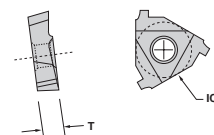

EXT SHOWN
INT OPPOSITE



Description	EDP Code	TPI	TPF	IC	(mm)		Connection	C6H	GP50	GP54	AC50	AC54
					T							
L43 6XL15 EXT	19154	6	1-1/2	1/2	4.80		5 - 7-5/8	●	●	●	●	●
L43 6XL75 EXT	20154	6	3/4	1/2	4.80		-	●	●	●	●	●
L43 5XL12 EXT	18154	5	1-1/4	1/2	4.80		8-5/8 - 10-3/4	●	●	●	●	●
L53 6XL15 EXT	19474	6	1-1/2	5/8	6.40		5 - 7-5/8	●	●	●	●	●
L53 6XL75 EXT	20474	6	3/4	5/8	6.40		-	●	●	●	●	●
L53 5XL12 EXT	18474	5	1-1/4	5/8	6.40		8-5/8 - 10-3/4	●	●	●	●	●
L43 6XL15 INT	19158	6	1-1/2	1/2	4.80		5 - 7-5/8	●	●	●	●	●
L43 6XL75 INT	20158	6	3/4	1/2	4.80		-	●	●	●	●	●
L43 5XL12 INT	18158	5	1-1/4	1/2	4.80		8-5/8 - 10-3/4	●	●	●	●	●
L53 6XL15 INT	19478	6	1-1/2	5/8	6.40		5 - 7-5/8	●	●	●	●	●
L53 6XL75 INT	20478	6	3/4	5/8	6.40		-	●	●	●	●	●
L53 5XL12 INT	18478	5	1-1/4	5/8	6.40		8-5/8 - 10-3/4	●	●	●	●	●

In an effort to improve our stock standard grade offering, there are periodic changes. Please see current price list for up-to-date grade offering.

- High performance choice in optimal conditions.
- ▲ Recommended grade under general conditions.

Material	C6H	GP50	GP54	AC50	AC54
Cast Iron				●	●
Non-Ferrous				●	●
Stainless/High Temp				●	●
Steel	▲	▲		●	●



ON-EDGE

API Buttress Threading Straight Hole

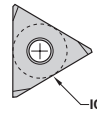
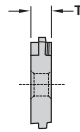

EXT SHOWN
INT OPPOSITE

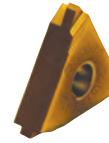

■ For holders and bars see pgs. 154-156

Description	EDP Code	TPI	TPF	IC	(mm)		Connection	Coating						
					T			C3	C6H	GP3	GP50	AC3	AC50	
TNMA 43 8B75 EXT	21394	8	3/4	1/2	4.80		U.S. Improved Buttress					●		
TNMA 44 5B75 EXT	16434	5	3/4	1/2	6.40		4-1/2 - 13-3/8					●		
TNMA 54 5B1 EXT -FC*	17514F	5	1	5/8	6.40		16 and larger					●		●
TNMA 54 5B75 EXT-FC	16514F	5	3/4	5/8	6.40		4-1/2 - 13-3/8					●		●
TNMA 43 8B75 INT	21398	8	3/4	1/2	4.80		U.S. Improved Buttress					●		
TNMA 44 5B75 INT	16438	5	3/4	1/2	6.40		4-1/2 - 13-3/8					●		●
TNMA 54 5B1 INT-FC	17518F	5	1	5/8	6.40		16 and larger					●		●
TNMA 54 5B75 INT-FC	16518F	5	3/4	5/8	6.40		4-1/2 - 13-3/8					●		●

*FC indicates 5° flank clearance

API Buttress Threading Countersink Hole

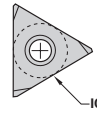
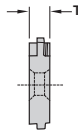

EXT SHOWN
INT OPPOSITE



■ For holders and bars see pgs. 154-156

Description	EDP Code	TPI	TPF	IC	(mm)		Connection	Coating						
					T			C3	C6H	GP3	GP50	AC3	AC50	
TNMC 43 8B75 EXT	21414	8	3/4	1/2	4.80		U.S. Improved Buttress					●		
TNMC 54 5B75 EXT-FC*	16534F	5	3/4	5/8	6.40		4-1/2 - 13-3/8					●		●
TNMC 54 5B1 EXT-FC	17534F	5	1	5/8	6.40		16 and larger					●		●
TNMC 43 8B75 INT	21418	8	3/4	1/2	4.80		U.S. Improved Buttress					●		●
TNMC 54 5B75 INT-FC	16538F	5	3/4	5/8	6.40		4-1/2 - 13-3/8					●		●
TNMC 54 5B1 INT-FC	17538F	5	1	5/8	6.40		16 and larger					●		●

*FC indicates 5° flank clearance

API Hughes H90 Threading Straight Hole

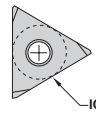
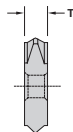

EXT SHOWN
INT OPPOSITE



■ For holders and bars see pgs. 154-156

Description	EDP Code	TPI	TPF	IC	(mm)		Connection	Coating						
					T			C3	C6H	GP3	GP50	AC3	AC50	
TNMA 55 H902 EXT	28554	3-1/2	2	5/8	7.98		3-1/2 - 6-5/8 H90					●		
TNMA 55 H903 EXT	29554	3-1/2	3	5/8	7.98		7 - 8-5/8 H90					●		
TNMA 56 H90S EXT	27Q14	3	1-1/4	5/8	9.58		2-3/8 - 3-1/2 Slimline					●		
TNMA 55 H902 INT	28558	3-1/2	2	5/8	7.98		3-1/2 - 6-5/8 H90					●		
TNMA 55 H903 INT	29558	3-1/2	3	5/8	7.98		7 - 8-5/8 H90					●		
TNMA 56 H90S INT	27Q18	3	1-1/4	5/8	9.58		2-3/8 - 3-1/2 Slimline					●		

API Hughes H90 Threading Countersink Hole

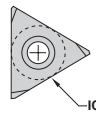
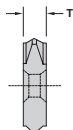

EXT SHOWN
INT OPPOSITE

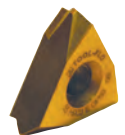

■ For holders and bars see pgs. 154-156

Description	EDP Code	TPI	TPF	IC	(mm)		Connection	Coating						
					T			C3	C6H	GP3	GP50	AC3	AC50	
TNMC 55 H902 EXT	28564	3-1/2	2	5/8	7.98		3-1/2 - 6-5/8 H90					●		
TNMC 55 H903 EXT	29564	3-1/2	3	5/8	7.98		7 - 8-5/8 H90					●		
TNMC 56 H90S EXT	27Q34	3	1-1/4	5/8	9.58		2-3/8 - 3-1/2 Slimline					●		
TNMC 55 H902 INT	28568	3-1/2	2	5/8	7.98		3-1/2 - 6-5/8 H90					●		
TNMC 55 H903 INT	29568	3-1/2	3	5/8	7.98		7 - 8-5/8 H90					●		
TNMC 56 H90S INT	27Q38	3	1-1/4	5/8	9.58		2-3/8 - 3-1/2 Slimline					●		

In an effort to improve our stock standard grade offering, there are periodic changes. Please see current price list for up to date grade offering.

- High performance choice in optimal conditions.
- ▲ Recommended grade under general conditions.

Material	C3	C6H	GP3	GP50	AC3	AC50
Cast Iron						
Non-Ferrous						
Stainless/High Temp						
Steel				▲		



ON-EDGE API Rotary Shoulder Connection Threading Straight Hole

■ For holders and bars see pgs. 154-156

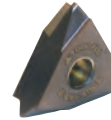
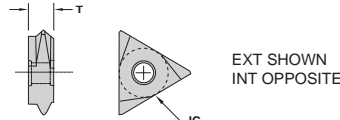

Description	EDP Code	TPI	TPF	IC	(mm)		Connection	Coating					
					T			C3	C6H	GP3	GP50	AC3	AC50
TNMA 54 530 EXT	13514	5	3	5/8	6.40		3-1/2 FH 2-3/8 - 4-1/2 Reg.				●		●
TNMA 55 425 EXT	09554	4	2	5/8	7.98		5-1/2 FH 6-5/8 FH 6-5/8 Reg.				●		●
TNMA 55 428 EXT	10554	4	2	5/8	7.98		NC 23-NC50 2-3/8 - 5-1/2 IF				●		●
TNMA 55 42F EXT	14554	4	2	5/8	7.98		V0.065*				●		●
TNMA 55 435 EXT	11554	4	3	5/8	7.98		5-1/2 Reg. 7-5/8 Reg 8-5/8 Reg.				●		●
TNMA 55 438 EXT	12554	4	3	5/8	7.98		NC56-NC71				●		●
TNMA 55 530 EXT	13554	5	3	5/8	7.98		3-1/2 FH 2-3/8 - 4-1/2 Reg.				●		●
TNMA 55 4PAC EXT	15554	4	1-1/2	5/8	7.98		American Open Hole				●		●
TNMA 54 530 INT	13518	5	3	5/8	6.40		3-1/2 FH 2-3/8 - 4-1/2 Reg.				●		●
TNMA 55 425 INT	09558	4	2	5/8	7.98		5-1/2 FH 6-5/8 FH 6-5/8 Reg.				●		●
TNMA 55 428 INT	10558	4	2	5/8	7.98		NC 23-NC50 2-3/8 - 5-1/2 IF				●		●
TNMA 55 42F INT	14558	4	2	5/8	7.98		V0.065*				●		●
TNMA 55 435 INT	11558	4	3	5/8	7.98		5-1/2 Reg. 7-5/8 Reg 8-5/8 Reg.				●		●
TNMA 55 438 INT	12558	4	3	5/8	7.98		NC56-NC71				●		●
TNMA 55 530 INT	13558	5	3	5/8	7.98		3-1/2 FH 2-3/8 - 4-1/2 Reg.				●		●
TNMA 55 4PAC INT	15558	4	1-1/2	5/8	7.98		American Open Hole				●		●

*Obsolescent thread form - see API Spec 7, 35th Edition, May 1, 1985 Section 9.4.

API Round Threading Straight Hole

■ For holders and bars see pgs. 154-156

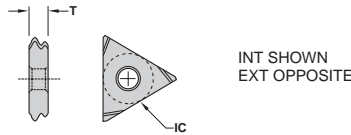

Description	EDP Code	TPI	TPF	IC	(mm)		Coating						
					T		C3	GP3	GP50	AC22	AC3	AC50	
TNMA 43 8RD EXT	32394	8	3/4	1/2	4.80						●	●	●
TNMA 43 10RD EXT	34394	10	3/4	1/2	4.80						●	●	●
TNMA 54 8RD EXT	32514	8	3/4	5/8	6.40						●	●	●
TNMA 43 8RD INT	32398	8	3/4	1/2	4.80						●	●	●
TNMA 43 10RD INT	34398	10	3/4	1/2	4.80						●	●	●
TNMA 54 8RD INT	32518	8	3/4	5/8	6.40						●	●	●

API Round Threading Countersink Hole

■ For holders and bars see pgs. 154-156

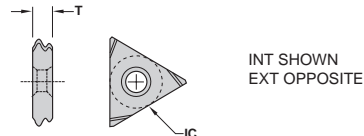

Description	EDP Code	TPI	TPF	IC	(mm)		Coating						
					T		C3	GP3	GP50	AC22	AC3	AC50	
TNMC 43 8RD EXT	32414	8	3/4	1/2	4.80						●	●	●
TNMC 43 10RD EXT	34414	10	3/4	1/2	4.80						●	●	●
TNMC 54 8RD EXT	32534	8	3/4	5/8	6.40						●	●	●
TNMC 43 8RD INT	32418	8	3/4	1/2	4.80						●	●	●
TNMC 43 10RD INT	34418	10	3/4	1/2	4.80						●	●	●
TNMC 54 8RD INT	32538	8	3/4	5/8	6.40						●	●	●

API Rotary Shoulder Connection Threading Countersink Hole

■ For holders and bars see pgs. 154-156

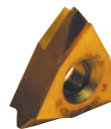
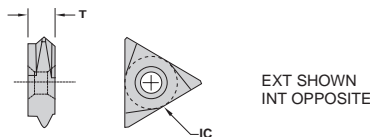

Description	EDP Code	TPI	TPF	IC	(mm)		Connection	Coating					
					T			C3	C6H	GP3	GP50	AC3	AC50
TNMC 54 530 EXT	13534	5	3	5/8	6.40		3-1/2 FH 2-3/8 - 4-1/2 Reg.				●		●
TNMC 55 425 EXT	09564	4	2	5/8	7.92		5-1/2 FH 6-5/8 FH 6-5/8 Reg.				●		●
TNMC 55 428 EXT	10564	4	2	5/8	7.92		NC 23-NC50 2-3/8 - 5-1/2 IF				●		●
TNMC 55 42F EXT*	14564	4	2	5/8	7.92		V0.065*				●		●
TNMC 55 435 EXT	11564	4	3	5/8	7.92		5-1/2 Reg. 7-5/8 Reg 8-5/8 Reg.				●		●
TNMC 55 438 EXT	12564	4	3	5/8	7.92		NC56-NC71				●		●
TNMC 55 530 EXT	13564	5	3	5/8	7.92		3-1/2 FH 2-3/8 - 4-1/2 Reg.				●		●
TNMC 55 4PAC EXT	15564	4	1-1/2	5/8	7.92		American Open Hole				●		●
TNMC 54 530 INT	13538	5	3	5/8	6.40		3-1/2 FH 2-3/8 - 4-1/2 Reg.				●		●
TNMC 55 425 INT	09568	4	2	5/8	7.92		5-1/2 FH 6-5/8 FH 6-5/8 Reg.				●		●
TNMC 55 428 INT	10568	4	2	5/8	7.92		NC 23-NC50 2-3/8 - 5-1/2 IF				●		●
TNMC 55 42F INT*	14568	4	2	5/8	7.92		V0.065*				●		●
TNMC 55 435 INT	11568	4	3	5/8	7.92		5-1/2 Reg. 7-5/8 Reg 8-5/8 Reg.				●		●
TNMC 55 438 INT	12568	4	3	5/8	7.92		NC56-NC71				●		●
TNMC 55 530 INT	13568	5	3	5/8	7.92		3-1/2 FH 2-3/8 - 4-1/2 Reg.				●		●
TNMC 55 4PAC INT	15568	4	1-1/2	5/8	7.92		American Open Hole				●		●

*Obsolescent thread form - see API Spec 7, 35th Edition, May 1, 1985 Section 9.4.

In an effort to improve our stock standard grade offering, there are periodic changes. Please see current price list for up-to-date grade offering.

- High performance choice in optimal conditions.
- ▲ Recommended grade under general conditions.

Material	C3	C6H	GP3	GP50	AC3	AC50
Cast Iron						●
Non-Ferrous						●
Stainless/High Temp						●
Steel					▲	●



VEE-BOTTOM

API Buttress Threading

■ For holders and bars see pgs. 213-214

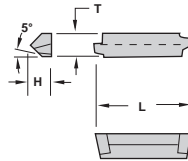

EXT SHOWN
INT OPPOSITE



Description	EDP Code	TPI	TPF	Dimensions (mm)			Connection	Coatings						
				T	L	H		C3	C6H	GP3	GP50	AC3	AC50	
V84 5B75 EXT-FC*	16614F	5	3/4	6.35	25.40	6.35	4-1/2 - 13-3/8				●			
V84 5B1 EXT-FC	17614F	5	1	6.35	25.40	6.35	16 AND LARGER				●			
V84 8B75 EXT-FC	21614F	8	3/4	6.35	25.40	6.35	U.S. IMPROVED BUTTRESS				●			
V84 5B75 INT-FC	16618F	5	3/4	6.35	25.40	6.35	4-1/2 - 13-3/8				●			
V84 5B1 INT-FC	17618F	5	1	6.35	25.40	6.35	16 AND LARGER				●			
V84 8B75 INT-FC	21618F	8	3/4	6.35	25.40	6.35	U.S. IMPROVED BUTTRESS				●			

*FC indicates 5° flank clearance

API Rotary Shoulder Connection Threading

■ For holders and bars see pgs. 213-214

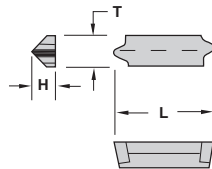

EXT SHOWN
INT OPPOSITE

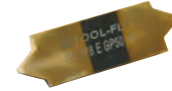

Description	EDP Code	TPI	TPF	Dimensions (mm)			Connection	Coatings					
				T	L	H		C3	C6H	GP3	GP50	AC3	AC50
V85 425 EXT	09634	4	2	7.92	25.40	6.35	5-1/2 - 6-5/8 FH, 6-5/8 REG				●	●	●
V85 428 EXT	10634	4	2	7.92	25.40	6.35	NC23 - 50, 2-3/8 - 5-1/2 IF				●	●	●
V85 42F EXT*	14634	4	2	7.92	25.40	6.35	VO.065*				●	●	●
V85 435 EXT	11634	4	3	7.92	25.40	6.35	5-1/2 REG, 7-5/8 REG, 8-5/8 REG				●	●	●
V85 438 EXT	12634	4	3	7.92	25.40	6.35	NC56 - NC71				●	●	●
V85 530 EXT	13634	5	3	7.92	25.40	6.35	3-1/2FH, 2-3/8 - 4-1/2 REG				●	●	●
V85 4PAC EXT	15634	4	1-1/2	7.92	25.40	6.35	American Open Hole				●	●	●
V85 425 INT	09638	4	2	7.92	25.40	6.35	5-1/2 - 6-5/8 FH, 6-5/8 REG				●	●	●
V85 428 INT	10638	4	2	7.92	25.40	6.35	NC23 - 50, 2-3/8 - 5-1/2 IF				●	●	●
V85 42F INT*	14638	4	2	7.92	25.40	6.35	VO.065*				●	●	●
V85 435 INT	11638	4	3	7.92	25.40	6.35	5-1/2 REG, 7-5/8 REG, 8-5/8 REG				●	●	●
V85 438 INT	12638	4	3	7.92	25.40	6.35	NC56 - NC71				●	●	●
V85 530 INT	13638	5	3	7.92	25.40	6.35	3-1/2FH, 2-3/8 - 4-1/2 REG				●	●	●
V85 4PAC INT	15638	4	1-1/2	7.92	25.40	6.35	American Open Hole				●	●	●

* Obsolete thread form, - See A.P.I. Spec 7, 35th Edition, May 1, 1995, Section 9.4

API Round Threading

■ For holders and bars see pgs. 213-214

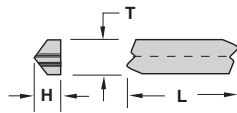

EXT SHOWN
INT OPPOSITE



Description	EDP Code	TPI	TPF	Dimensions (mm)			Coatings						
				T	L	H	C3	C6H	GP3	GP50	AC3	AC50	
V84 10RD EXT	34614	10	3/4	6.35	25.40	6.35					●	●	●
V84 10RD INT	34618	10	3/4	6.35	25.40	6.35					●	●	●
V84 8RD EXT	32614	8	3/4	6.35	25.40	6.35					●	●	●
V84 8RD INT	32618	8	3/4	6.35	25.40	6.35					●	●	●

API VAM Threading

■ For holders and bars see pgs. 213-214

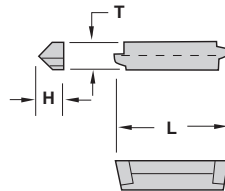

EXT SHOWN
INT OPPOSITE



Description	EDP Code	TPI	TPF	Dimensions (mm)			Coatings						
				T	L	H	C3	C6H	GP3	GP50	AC3	AC50	
V84 5 VAM EXT	23614	5	3/4	6.35	25.4	6.35					●		
V84 5 VAM INT	23618	5	3/4	6.35	25.4	6.35					●		
V84 6 VAM EXT	24614	6	3/4	6.35	25.4	6.35					●		
V84 6 VAM INT	24618	6	3/4	6.35	25.4	6.35					●		
V84 8 VAM EXT	25614	8	3/4	6.35	25.4	6.35					●		
V84 8 VAM INT	25618	8	3/4	6.35	25.4	6.35					●		

In an effort to improve our stock standard grade offering, there are periodic changes. Please see current price list for up-to-date grade offering.

- High performance choice in optimal conditions.
- ▲ Recommended grade under general conditions.

Material	C3	C6H	GP3	GP50	AC3	AC50
Cast Iron						●
Non-Ferrous						●
Stainless/High Temp						●
Steel					▲	●



VEE-BOTTOM API X-Line Threading

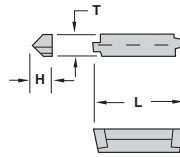

EXT SHOWN
INT OPPOSITE

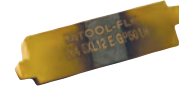

For holders and bars see pgs. 213-214

Description	EDP Code	TPI	TPF	Dimensions (mm)			Connection	Coatings					
				T	L	H		C3	C6H	GP3	GP50	AC3	AC50
V84 5XL12 EXT	18614	5	1-1/4	6.35	25.4	6.35	8-5/8 - 10-3/4				●	●	●
V84 5XL12 INT	18618	5	1-1/4	6.35	25.4	6.35	8-5/8 - 10-3/4				●	●	●
V84 6XL15 EXT	19614	6	1-1/2	6.35	25.4	6.35	5 - 7-5/8				●	●	●
V84 6XL15 INT	19618	6	1-1/2	6.35	25.4	6.35	5 - 7-5/8				●	●	●
V84 6XL75 EXT	20614	6	3/4	6.35	25.4	6.35	-				●	●	●
V84 6XL75 INT	20618	6	3/4	6.35	25.4	6.35	-				●	●	●

API 46° Ring Grooves APIP

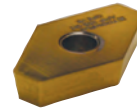
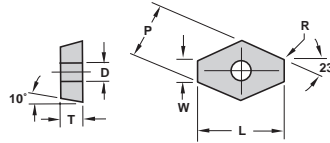

For holders see pg. 22

Description	EDP Code	Dimensions (mm)						Style	Coatings			
		R	W	P	T	D	L		C6H	GP25	GP6	AC25
APIP 086-3	754000	0.38	2.01	9.45	4.75	-	19.50	Clamp	●	●	●	●
APIP 131-3	754005	0.79	3.18	10.34	4.75	-	19.50	Clamp	●	●	●	●
APIP (PGN-1A)	754003	0.79	3.33	10.52	4.75	-	19.50	Clamp	●	●	●	●
APIP 162-3 (PGN-6A)	75403	0.79	3.96	11.10	4.75	-	19.50	Clamp	●	●	●	●
APIP (PGN-7A)	75887	0.79	5.16	12.29	4.75	-	19.50	Clamp	●	●	●	●
APIP 203-3 (PGN-2A)	75413	0.79	5.00	14.58	4.75	-	25.40	Clamp	●	●	●	●
APIP 203-3H	75413H	0.79	5.00	14.58	4.75	5.16	25.40	Lock Pin	●	●	●	●
APIP 213-3	75423	1.57	5.23	14.58	4.75	5.16	25.40	Lock Pin	●	●	●	●
APIP 265-3	75433	0.79	6.60	16.08	4.75	6.35	25.40	Lock Pin	●	●	●	●
APIP 281-3	75443	0.79	7.04	16.38	4.75	6.35	25.40	Lock Pin	●	●	●	●
APIP 300-3	75463	0.79	7.49	16.81	4.75	6.35	25.40	Lock Pin	●	●	●	●
APIP 329-3	75473	0.79	8.23	17.35	4.75	6.35	25.40	Lock Pin	●	●	●	●
APIP 355-3	75476	0.79	8.89	18.08	4.75	6.35	25.40	Lock Pin	●	●	●	●
APIP 420-3	75490	0.79	10.54	19.61	4.75	6.35	25.40	Lock Pin	●	●	●	●
HEAVY DUTY												
APIP 284-3	75453	1.57	7.06	18.11	4.75	6.35	30.16	Lock Pin	●	●	●	●
APIP 162-4NL	75404NL	0.79	3.96	18.62	6.35	6.35	38.10	Lock Pin	●	●	●	●
APIP 162-4 (Counter sink hole)	75404	0.79	3.96	18.62	6.35	6.35	38.10	Screw	●	●	●	●
APIP 203-4NL	75414NL	0.79	5.00	19.63	6.35	6.35	38.10	Lock Pin	●	●	●	●
APIP 203-4 (Counter sink hole)	75414	0.79	5.00	19.63	6.35	6.35	38.10	Screw	●	●	●	●
APIP 213-4 (Counter sink hole)	75424	1.57	5.23	19.63	6.35	6.35	38.10	Screw	●	●	●	●
APIP 265-4 (Counter sink hole)	75436	0.79	6.60	19.63	6.35	6.35	34.93	Screw	●	●	●	●
APIP 281-4 (Counter sink hole)	75444	0.79	7.04	19.63	6.35	6.35	33.34	Screw	●	●	●	●
APIP 300-4 (Counter sink hole)	75464	0.79	7.49	19.63	6.35	6.35	32.54	Screw	●	●	●	●
APIP 329-4	75474	0.79	8.23	19.63	6.35	6.35	30.96	Lock Pin	●	●	●	●
APIP 355-4	75484	0.79	8.89	19.63	6.35	6.35	29.37	Lock Pin	●	●	●	●
APIP 420-4	75492	0.79	10.54	19.63	6.35	6.35	25.40	Lock Pin	●	●	●	●

In an effort to improve our stock standard grade offering, there are periodic changes. Please see current price list for up-to-date grade offering.

- High performance choice in optimal conditions.
- ▲ Recommended grade under general conditions.

Material	C3	C6H	GP3	GP50	AC3	AC50
Cast Iron						
Non-Ferrous						
Stainless/High Temp						
Steel			▲			●

Ring Groove Specifications

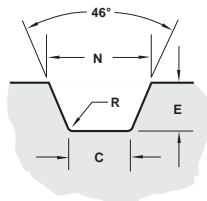

Groove Description

Groove Description	Dimensions (mm)				Insert Description
	C	E	N	R	
BX-150	6.60	5.59	11.43	0.79	APIP 265-3 or APIP 265-4
BX-151	7.04	5.59	11.84	0.79	APIP 281-3 or APIP 281-4
BX-152	7.49	5.84	12.65	0.79	APIP 300-3 or APIP 300-4
BX-153	8.23	6.86	14.07	0.79	APIP 329-3 or APIP 329-4
BX-154	8.89	7.62	15.39	0.79	APIP 355-3 or APIP 355-4
BX-155	10.54	8.38	17.73	0.79	APIP 420-3 or APIP 420-4
R19, 20, 22, 25, 29, 33, 36, 40, 43, 48, 52, 56, 59, 64, 68, 72, 76 & RX-20	3.18	6.35	8.74	0.79	APIP 131-3
R21, 23, 24, 26, 27, 30, 31, 34, 35, 37, 39, 41, 44, 45, 49, 53, 57, 61, 65, 69, 82, 84, 92, 99 & RX-215	5.00	7.87	11.91	0.79	APIP 203-3, 203-3H, 203-4
R28, 32, 46, 73 & 85	5.23	9.65	13.49	1.57	APIP 213-4
R38, 50, 54, 62, 66, 77, 86 & 87	7.06	11.18	16.66	1.57	APIP 213-4, 284-3
R42, 47, 70, 74, 83, 88, 89 & 93	8.89	12.70	19.84	1.57	APIP 213-4
R51, 58 & 90	10.72	14.22	23.01	1.57	APIP 213-4
RX-201 & 205	2.01	4.06	5.56	0.38	APIP 086-3
RX-210	3.96	6.35	9.53	0.79	APIP 162-3, PGN-1A

RING GROOVING HOLDERS

FGNR

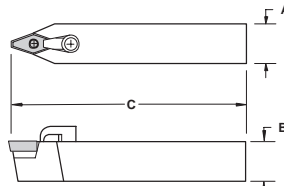

PARTS

Description	EDP Code	Insert	Dimensions (mm)			Seat	Seat/Insert Screw	Clamp	Clamp Screw
			A	B	C				
FGNR 2525-0863	928025M00	APIP 086-3	25.0	25.0	150	-	-	CLM-12	STCM8
FGNR-2525-1A/1313	928025M04	PGN 1A/131/3	25.0	25.0	150	FGS1A	SFM10	CLM-12	XNS-510
FGNR-2525-2A*	928025M12	PGN 2A/213-3	25.0	25.0	150	FGS2ANL	SM46	CLM-12	XNSM-0825
FGNR-3232-2A*	928032M12	PGN 2A/213-3	32.0	32.0	170	FGS2ANL	SM46	CLM-12	XNSM-0825
FGNR 2525-6A	928025M06	PGN 6A	25.0	25.0	150	-	-	CL-30	XNSM-0825
FGNR-2525-7A	928025M15	PGN 7A	25.0	25.0	150	-	-	CL-30	XNSM-0825
FGNR-3232-1624	928032M13	APIP 162-4	32.0	32.0	170	-	SD-3	CL-30	XNS-510
FGNR-4040-1624	928040M13	APIP 162-4	40.0	40.0	170	-	SD-3	CL-30	XNS-510
FGNR-3232-2034	928032M14	APIP 203-4	32.0	32.0	170	-	SD-3	CL-30	XNS-510
FGNR-4040-2034	928040M14	APIP 203-4	40.0	40.0	170	-	SD-3	CL-30	XNS-510
FGNR-3232-2134	928032M15	APIP 213-4	32.0	32.0	170	-	SD-3	CL-30	XNS-510
FGNR-3232-2654	928032M16	APIP 265-4	32.0	32.0	170	-	SD-3	CL-30	XNSM-0825
FGNR-3232-2814	928032M11	APIP 281-4	32.0	32.0	170	-	SD-3	CL-30	XNSM-0825
FGNR-3232-3004	928032M34	APIP 300-4	32.0	32.0	170	-	SD-3	CL-30	XNSM-0825
FGNR-3232-4203	928032M19	APIP 420-3	32.0	32.0	170	-	NLM56	CL-30	XNSM-0825

* Holder can be used with APIP 203-3H (whole) insert. Order NL-46 lock pin to replace the S46 seat screw.

INTERCHANGEABLE HEADS FLO-LOCK

H-FLEL/R*

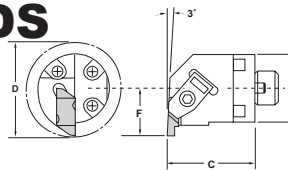

PARTS

Description	EDP Code	Insert	Dimensions (mm)				Clamp	Clamp Screw
			d	C	F	Min. Bore (D)		
H32M-FLER3W	935032M16W	FL-3L	32.0	41.28	22.23	44.45	TF-73	SSM-51
H40M-FLER3W	935040M16W	FL-3L	40.0	41.28	25.40	50.80	TF-73	SSM-51
H44M-FLER3W	935044M16E	FL-3L	44.0	41.28	28.58	57.15	TF-73	SSM-51
H50M-FLER3W	935050M16W	FL-3L	50.0	41.28	31.75	63.50	TF-73	SSM-51
H60M-FLER3W	935060M16W	FL-3L	60.0	41.28	38.10	76.20	TF-73	SSM-51
H44M-FLER4W	935044M20W	FL-4L	44.0	41.28	31.75	57.15	TF-73	SSM-51
H50M-FLER4W	935050M20W	FL-4L	50.0	41.28	34.93	63.50	TF-73	SSM-51
H57M-FLER4W	935057M20W	FL-4L	57.0	41.28	38.10	63.50	TF-73	SSM-51
H60M-FLER4W	935060M20W	FL-4L	60.0	41.28	41.28	76.20	TF-73	SSM-51
H44M-FLER6W	935044M28W	FL-6L	44.0	41.28	31.75	63.50	TF-121	SSM-51
H50M-FLER6W	935050M28W	FL-6L	50.0	41.28	34.93	69.85	TF-121	SSM-51
H60M-FLER6W	935060M28W	FL-6L	60.0	41.28	41.28	82.55	TF-121	SSM-51

*Left hand quoted on request.

HS-FLEL/R*

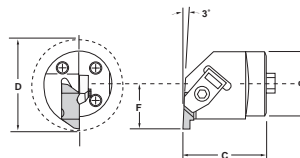

PARTS

Description	EDP Code	Insert	Dimensions (mm)				Clamp	Clamp Screw
			d	C	F	Min. Bore (D)		
HS32-FLER3W	9IHS65032M16	FL-3L	32.0	34.04	22.00	43.94	TF-73	SSM-51
HS40-FLER3W	9IHS65040M16	FL-3L	40.0	40.13	27.99	56.13	TF-73	SSM-51
HS50-FLER3W	9IHS65050M16	FL-3L	50.0	41.91	35.05	70.10	TF-73	SSM-51
HS60-FLER3W	9IHS65060M16	FL-3L	60.0	44.45	44.20	88.39	TF-73	SSM-51
HS50-FLER4W	9IHS65050M20	FL-4L	50.0	41.91	35.05	70.10	TF-73	SSM-51
HS60-FLER4W	9IHS65060M20	FL-4L	60.0	44.45	44.20	88.39	TF-73	SSM-51

*Left hand quoted on request.

LAYDOWN H-LNFR/L*

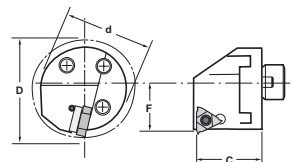

PARTS

Description	EDP Code	Insert	Dimensions (mm)				Seat	Clamp	Clamp Screw	Lock Pin
			d	C	F	Min. Bore (D)				
H32M-LNFR-43	9IH42032M56	L43	32.0	41.28	19.43	36.83	-	CLM6	STCM9	NLM44
H40M-LNFR-43	9IH42040M56	L43	40.0	41.28	22.61	44.70	-	CLM6	STCM9	NLM44
H50M-LNFR-43	9IH42050M56	L43	50.0	41.28	32.54	60.96	LS43	CLM6	XNSM0515	NLM46
H40M-LNFR-53API	9IH44040M62	L53	40.0	41.28	22.61	44.70	-	CLM20	STCM11	NLM56
H50M-LNFR-53API	9IH44050M62	L53	50.0	41.28	32.54	60.96	-	CLM20	STCM11	NLM56
H40M-LNFR-54API	9IH44040M64	LDS 54	40.0	41.28	22.61	44.70	-	CLM20	STCM11	H410-1
H50M-LNFR-54API	9IH44050M64	LDS 54	50.0	41.28	32.54	60.96	-	CLM20	STCM11	NLM56

*Non API heads only for 8RD, 10RD, 5B75, 5B1 threads. API heads required for rotary shoulder connections threads.



INTERCHANGEABLE HEADS

HS-LNFR/L*

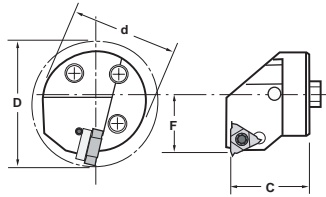

RH SHOWN

PARTS

Description	EDP Code	Insert	Dimensions (mm)				Min. Bore (D)	Clamp	Clamp Screw	Lock Pin
			d	C	F					
HS32-LNFR-43	9IHS42032M56	L43	32.0	32.00	22.00	39.88	CLM6	STCM9	NLM44	
HS40-LNFR-43	9IHS42040M56	L43	40.0	32.00	27.00	50.04	CLM6	STCM9	NLM44	
HS50-LNFR-43	9IHS42050M56	L43	50.0	39.88	35.00	62.99	CLM6	STCM9	NLM44	
HS40-LNFR-53API	9IHS4440M62	L53	40.00	32.00	27.00	50.04	CLM20	STCM11	NLM56	
HS50-LNFR-53API	9IHS4450M62	L53	50.00	39.88	35.00	62.99	CLM20	STCM11	NLM56	
HS40-LNFR-54API	9IHS4440M64	LDS 54	40.00	32.00	27.00	50.04	CLM20	STCM11	H410-1	
HS50-LNFR-54API	9IHS4450M64	LDS 54	50.00	39.88	35.00	62.99	CLM20	STCM11	NLM56	

*Non API heads only for 8RD, 10RD, 5B75, 5B1 threads. API heads required for rotary shoulder connections threads.

LAYDOWN

H-AVR/L*

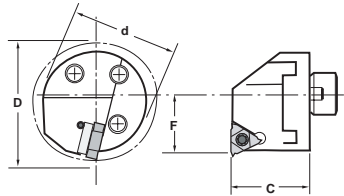

RH SHOWN

PARTS

Description	EDP Code	Insert	Dimensions (mm)				Min. Bore (D)	Insert Screw	Seat Screw	Seat
			d	C	F					
H25M-AVR-3R	9IH18025M361	16NR	25.00	41.28	16.51	30.48	PT-586T	SYM-3	YI3	
H32M-AVR-3R	9IH18032M361	16NR	32.00	41.28	19.43	36.83	PT-586T	SYM-3	YI3	
H40M-AVR-3R	9IH18040M361	16NR	40.00	41.28	22.61	44.70	PT-586T	SYM-3	YI3	
H50M-AVR-3R	9IH18050M361	16NR	50.00	41.28	32.54	60.96	PT-586T	SYM-3	YI3	
H40M-AVR-4R	9IH18040M401	22NR	40.00	41.28	24.84	44.70	SAM-4	SYM-4	YI4	
H50M-AVR-4R	9IH18050M401	22NR	50.00	41.28	32.54	60.96	SAM-4	SYM-4	YI4	

*Left hand quoted on request.

HS-AVR/L*

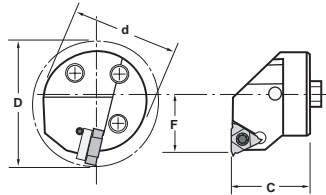

RH SHOWN

PARTS

Description	EDP Code	Insert	Dimensions (mm)				Min. Bore (D)	Insert Screw	Seat Screw	Seat
			d	C	F					
HS25-AVR-3R	9IHS18025M361	16NR	25.00	24.89	16.99	32.00	PT-586T	SYM-3	YI3	
HS32-AVR-3R	9IHS18032M361	16NR	32.00	32.00	22.00	39.88	PT-586T	SYM-3	YI3	
HS40-AVR-3R	9IHS18040M361	16NR	40.00	32.00	27.00	50.04	PT-586T	SYM-3	YI3	
HS50-AVR-3R	9IHS18050M361	16NR	50.00	39.88	35.00	62.99	PT-586T	SYM-3	YI3	
HS40-AVR-4R	9IHS18040M401	22NR	40.00	32.00	27.00	50.04	SAM-4	SYM-4	YI4	
HS50-AVR-4R	9IHS18050M401	22NR	50.00	39.88	35.00	62.99	SAM-4	SYM-4	YI4	

*Left hand quoted on request.

ON-EDGE

H-MTHOR/L*

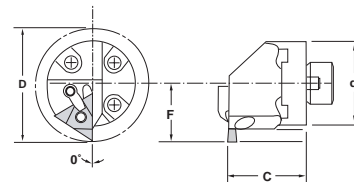

RH SHOWN

PARTS

Description	EDP Code	Insert	Dimensions (mm)				Min. Bore (D)	Clamp	Clamp Screw	Lock Pin
			d	C	F					
H25M-MTHOR-3	9IH73025M48	TNMA/C 32	25.00	41.28	17.48	42.93	CLM6	XNSM0515	NLM33	
H32M-MTHOR-3	9IH73032M48	TNMA/C 32	32.00	41.28	20.27	45.42	CLM6	XNSM0515	NLM33	
H40M-MTHOR-3	9IH73040M48	TNMA/C 32	40.00	41.28	23.44	47.63	CLM6	XNSM0515	NLM33	
H32M-MTHOR-4	9IH73032M56	TNMA/C 43	32.00	41.28	26.62	61.47	CLM6	XNSM0515	NLM44	
H40M-MTHOR-4	9IH73040M56	TNMA/C 43	40.00	41.28	29.79	66.68	CLM6	XNSM0515	NLM44	
H44M-MTHOR-4	9IH73044M56	TNMA/C 43	44.00	41.28	32.97	73.03	CLM6	XNSM0515	NLM44	
H50M-MTHOR-4	9IH73050M56	TNMA/C 43	50.00	41.28	36.14	73.03	CLM6	XNSM0515	NLM44	
H63M-MTHOR-4	9IH73063M56	TNMA/C 43	63.00	41.28	42.49	85.73	CLM6	XNSM0515	NLM44	
H40M-MTHOR-5	9IH73040M64	TNMA/C 54	40.00	41.28	29.79	81.28	CLM20	STCM11	NLM56	
H44M-MTHOR-5	9IH73044M64	TNMA/C 54	44.00	41.28	32.97	82.55	CLM20	STCM11	NLM56	
H50M-MTHOR-5	9IH73050M64	TNMA/C 54	50.00	41.28	36.14	82.55	CLM20	STCM11	NLM56	
H63M-MTHOR-5	9IH73063M64	TNMA/C 54	63.00	41.28	42.49	85.73	CLM20	STCM11	NLM56	

*Left hand quoted on request.



INTERCHANGEABLE HEADS

ON-EDGE

HS-MTHOR/L*

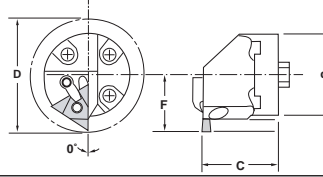

RH SHOWN

PARTS

Description	EDP Code	Insert	Dimensions (mm)				Clamp	Clamp Screw	Lock Pin
			d	C	F	Min. Bore (D)			
HS25-MTHOR-3	9IHS73025M48	TNMA/C 32	25.00	24.89	17.22	42.93	CLM6	XNSM0515	NLM33
HS32-MTHOR-3	9IHS73032M48	TNMA/C 32	32.00	32.00	20.32	45.42	CLM6	XNSM0515	NLM33
HS40-MTHOR-3	9IHS73040M48	TNMA/C 32	40.00	32.00	23.70	47.63	CLM6	XNSM0515	NLM33
HS32-MTHOR-4	9IHS73032M56	TNMA/C 43	32.00	32.00	26.67	61.47	CLM6	XNSM0515	NLM44
HS40-MTHOR-4	9IHS73040M56	TNMA/C 43	40.00	32.00	30.56	66.68	CLM6	XNSM0515	NLM44
HS50-MTHOR-4	9IHS73050M56	TNMA/C 43	50.00	39.88	35.89	73.03	CLM6	XNSM0515	NLM44
HS60-MTHOR-4	9IHS73060M56	TNMA/C 43	60.00	39.88	40.72	85.73	CLM6	XNSM0515	NLM44
HS40-MTHOR-5	9IHS73040M64	TNMA/C 54	40.00	32.00	30.56	81.28	CLM6	STCM11	NLM56
HS50-MTHOR-5	9IHS73050M64	TNMA/C 54	50.00	39.88	35.89	82.55	CLM20	STCM11	NLM56
HS60-MTHOR-5	9IHS73060M64	TNMA/C 54	60.00	39.88	40.72	85.73	CLM20	STCM11	NLM56

*Left hand quoted on request.

VEE BOTTOM

H-CDHOR/L*

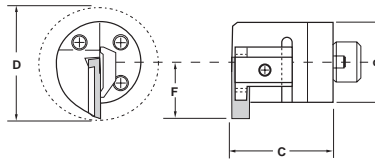

RH SHOWN

PARTS

Description	EDP Code	Insert	Dimensions (mm)				Clamp	Clamp Screw
			d	C	F	Min. Bore (D)		
H25M-CDHOR-8	9IH68025M82	V84/V85	25.00	41.28	23.50	38.74	CBLM-84	SM-526
H32M-CDHOR-8	9IH68032M82	V84/V85	32.00	41.28	22.23	40.64	CBLM-84	SM-526
H40M-CDHOR-8	9IH68040M82	V84/V85	40.00	41.28	25.40	46.99	CBLM-84	SM-526
H50M-CDHOR-8	9IH68050M82	V84/V85	50.00	41.28	32.64	60.58	CBLM-84	SM-526
H60M-CDHOR-8	9IH68060M82	V84/V85	60.00	41.28	38.10	72.39	CBLM-84	SM-526
H50M-CDHOR-9	9IH68050M86	V96/V98	50.00	41.28	35.81	63.75	CBL-98	SS110
H60M-CDHOR-9	9IH68060M86	V96/V98	60.00	41.28	40.23	74.55	CBL-98	SS110
H60M-CDHOR-12	9IH68060M92	V120	60.00	41.28	46.23	80.52	CBL-120	SB100

*Left hand quoted on request.

HS-CDHOR/L*

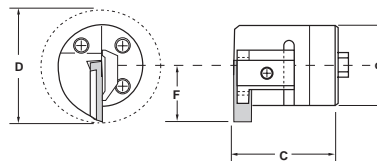

RH SHOWN

PARTS

Description	EDP Code	Insert	Dimensions (mm)				Clamp	Clamp Screw
			d	C	F	Min. Bore (D)		
HS25-CDHOR-8	9IHS68025M82	V84/V85	25.00	34.42	23.50	38.53	CBLM-84	SM-526
HS32-CDHOR-8	9IHS68032M82	V84/V85	32.00	41.28	22.23	40.64	CBLM-84	SM-526
HS40-CDHOR-8	9IHS68040M82	V84/V85	40.00	41.28	27.53	50.06	CBLM-84	SM-526
HS50-CDHOR-8	9IHS68050M82	V84/V85	50.00	41.28	32.54	60.10	CBLM-84	SM-526
HS60-CDHOR-8	9IHS68060M82	V84/V85	60.00	41.28	37.49	70.00	CBLM-84	SM-526
HS50-CDHOR-9	9IHS68050M86	V96/V98	50.00	41.28	34.59	62.15	CBL-98	SS110
HS60-CDHOR-9	9IHS68060M86	V96/V98	60.00	41.28	39.57	72.09	CBL-98	SS110
HS60-CDHOR-12	9IHS68060M92	V120	60.00	41.28	44.45	76.96	CBL-120	SB100

*Left hand quoted on request.



S-4400MW

Steel Shank with Through Coolant

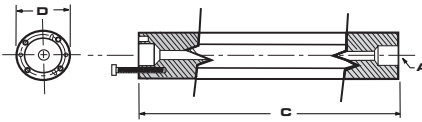

Description	EDP Code	Head Style	Dimensions (mm)		A	PARTS Screw (4 req/d)
			D	C		
S-4425MW	9IBS4425MW	H25M-	25.00	200.00	1/4 - 18NPT	SSM61
S-4432MW	9IBS4432MW	H32M-	32.00	200.00	3/8 - 18NPT	SSM81
S-4440MW	9IBS4440MW	H40M-	40.00	250.00	3/8 - 18NPT	SSM85
S-4444MW	9IBS4444MW	H44M-	44.00	300.00	3/8 - 18NPT	SSM100
S-4450MW	9IBS4450MW	H50M-	50.00	300.00	3/8 - 18NPT	SSM100
S-4457MW	9IBS4457MW	H57M-	57.00	400.00	3/8 - 18NPT	SSM100
S-4460MW	9IBS4460MW	H60M-	60.00	430.00	3/8 - 18NPT	SSM83

S-4400W48

Steel Shank with Through Coolant

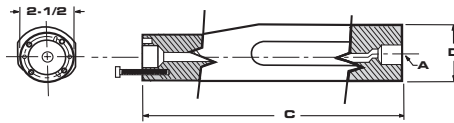

Description	EDP Code	Head Style	Dimensions (mm)		A	PARTS Screw (4 req/d)
			D	C		
S-4440W48	9IBS4440W48	H40M-	72.00	450.00	3/8 - 18NPT	SSM89

S-570

Steel Shank with Through Coolant

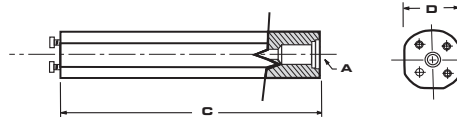

Description	EDP Code	Head Style	Dimensions (mm)		A	PARTS Screw (4 req/d)
			D	C		
S-570-10-16	9IBS5701016	HS16-	16.00	100.00	1/8 - 27NPT	SSM62
S-570-12-20	9IBS5701220	HS20-	20.00	130.00	1/4 - 18NPT	SSM63
S-570-16-25	9IBS5701625	HS25-	25.00	200.00	1/4 - 18NPT	SSM64
S-570-20-32	9IBS5702032	HS32-	32.00	250.00	3/8 - 18NPT	SSM81
S-570-24-40	9IBS5702440	HS40-	40.00	300.00	1/2 - 14NPT	SSM100
S-570-32-50	9IBS5703250	HS50-	50.00	350.00	1/2 - 14NPT	SSM94
S-570-40-60	9IBS5704060	HS60-	60.00	450.00	1/2 - 14NPT	SSM95

H/HS-BLANKS

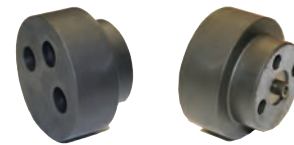
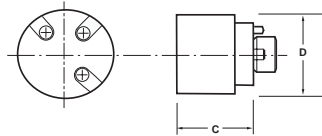

Description	EDP Code	Dimensions (mm)	
		D	C
H25M-BLANK RH/LH*	9IH16BLKRH/LH	38.10	41.40
H40M-BLANK RH/LH*	9IH20BLKRH/LH	41.28	41.40
H50M-BLANK RH/LH*	9IH24BLKRH/LH	50.80	41.40
H50M-BLANK RH/LH*	9IH28BLKRH/LH	50.80	41.40
H60M-BLANK RH/LH*	9IH32BLKRH/LH	69.85	41.40
H60M-BLANK LONG RH/LH*	9IH40BLKLNKRH/LH	69.85	48.26
HS25-BLANK RH/LH*	9IHS25BLKRH/LH	34.04	38.10
HS32-BLANK RH/LH*	9IHS32BLKRH/LH	44.20	42.29
HS40-BLANK RH/LH*	9IHS40BLKRH/LH	53.34	42.55
HS50-BLANK RH/LH*	9IHS50BLKRH/LH	68.78	41.91
HS60-BLANK RH/LH*	9IHS60BLKRH/LH	88.39	45.72

*Specify right or left hand when ordering.

CROSSOVER CHART

INTERCHANGEABLE HEAD

TOOL-FLO DESCRIPTION

KENNAMETAL®

SANDVIK®

<p>H Style</p>	H_-FLER_W	H_-NER_W	
	H_-AVR_	H_-LSER-	
	H_-MTHOR_	H_-MTHOR_	
	H_-MCLNR_	H_-MCLNR_	
	H_-MDUNR_	H_-MDUNR_	
	H_-MSKNR_	H_-MSKNR_	
	H_-MTFNR_	H_-MTFNR_	
	H_-MVUNR_	H_-MVUNR_	
	H_-MWLNR_	H_-MWLNR_	
	<p>HS Style</p>	HS_-FLER_W	
HS_-AVR_			R566-4KFC-_-_-
HS_-MTHOR_			
HS_-MCLNR_			R571.31C-_-_-
HS_-MDUNR_			R571.35C-_-_-
HS_-MSKNR_			
HS_-MTFNR_			
HS_-MVUNR_			
HS_-MWLNR_			



EXTERNAL SCARFING INSERTS

SPUB-63 - External 3/4" Square 4-sided - OD

■ Holders may be quoted upon request.

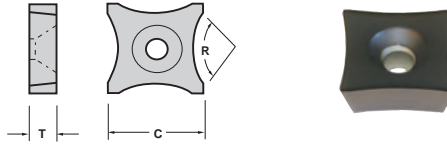

Description	EDP Code	Tube Diameter	Dimensions (mm)			Coatings				
			T	C	R - Radius	GP50	GP54	AC22	AC50	ZA50
SPUB-63B-E	SI63EB	up to 7/8"	4.76	19.05	12.07	●			●	●
SPUB-63C-E	SI63EC	7/8" - 1-1/8"	4.76	19.05	14.99	●			●	●
SPUB-63D-E	SI63ED	1-1/8" - 1-1/2"	4.76	19.05	19.94	●			●	●
SPUB-63E-E	SI63EE	1-1/2" - 1-7/8"	4.76	19.05	25.02	●			●	●
SPUB-63F-E	SI63EF	1-7/8" - 2-1/4"	4.76	19.05	29.97	●			●	●
SPUB-63G-E	SI63EG	2-1/4" - 3-1/8"	4.76	19.05	40.01	●			●	●
SPUB-63H-E	SI63EH	3-1/8" - 3-7/8"	4.76	19.05	50.04	●			●	●
SPUB-63I-E	SI63EI	3-7/8" - 4-7/8"	4.76	19.05	62.74	●			●	●
SPUB-63J-E	SI63EJ	4-7/8" - 5-7/8"	4.76	19.05	75.44	●			●	●
SPUB-63K-E	SI63EK	5-7/8" - 6-7/8"	4.76	19.05	88.14	●			●	●
SPUB-63L-E	SI63EL	6-7/8" - 7-7/8"	4.76	19.05	100.84	●			●	●
SPUB-63M-E	SI63EM	7-7/8" and up	4.76	19.05	None	●			●	●
SPUB-63M-30-E	SI63EM30	30° Relief	4.76	19.05	None	●			●	●

1" Square 4-sided - OD

■ Holders may be quoted upon request.

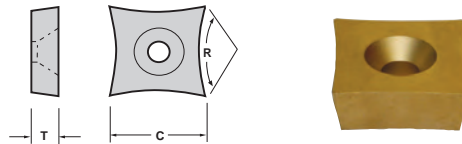

Description	EDP Code	Tube Diameter	Dimensions (mm)			Coatings				
			T	C	R - Radius	GP50	GP54	AC22	AC50	ZA50
SQ86-14-0-E	SI86E0	ANY	9.53	25.40	None	●			●	●
SQ86-14-2.5-E	SI86E25	3" - 4-3/4"	9.53	25.40	63.50	●			●	●
SQ86-10-3.4-E	SI86E34	4-3/4" - 6-3/4"	9.53	25.40	86.36	●			●	●
SQ86-14-4.5-E	SI86E45	6-3/4" - 8-3/4"	9.53	25.40	114.30	●			●	●
SQ86-10-9.5-E	SI86E95	8-3/4" - 18"	9.53	25.40	241.30	●			●	●

SQ86 - Internal 1" Square 4-sided - ID

■ Holders may be quoted upon request.

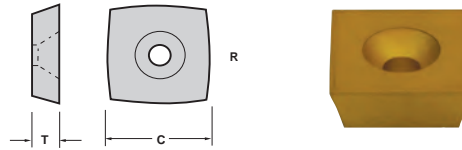

Description	EDP Code	Tube Diameter	Dimensions (mm)			Coatings				
			T	C	R - Radius	GP50	GP54	AC22	AC50	ZA50
SQ86-14-0-I	SI86I0	ANY	9.53	25.40	None	●			●	●
SQ86-14-2.5-I	SI86I25	3" - 4-3/4"	9.53	25.40	63.50	●			●	●
SQ86-10-3.4-I	SI86I34	4-3/4" - 6-3/4"	9.53	25.40	86.36	●			●	●

INTERNAL SCARFING INSERTS

IDR

■ Holders may be quoted upon request.



Description	EDP Code	Int'l Tube Diameter	Description	Coatings				
				GP50	GP54	AC22	AC50	ZA50
IDR-2010	IDSR2010	9/16" - 11/16"	#1					
IDR-2020	IDSR2020	11/16" - 13/16"	#2			●	●	●
IDR-2030	IDSR2030	13/16" - 1-1/32"	#3			●	●	●
IDR-2040	IDSR2040	1-1/32" - 1-3/8"	#4			●	●	●
IDR-2050	IDSR2050	5/16" - 1-7/16"	#5			●	●	●
IDR-2060	IDSR2060	1-1/32" - 1-1/8"	#6			●	●	●
IDR-2070	IDSR2070	1-1/8" - 1-3/16"	#7			●	●	●
IDR-2080	IDSR2080	1-3/16" - 1-3/8"	#8			●	●	●
IDR-2090	IDSR2090	1-1/4" - 1-5/8"	#9			●	●	●
IDR-2100	IDSR2100	1-5/8" - 2"	#10			●	●	●
IDR-2110	IDSR2110	1-7/8" - 2-7/8"	#11			●	●	●
IDR-2120	IDSR2120	2-3/4" - 3-3/8"	#12			●	●	●
IDR-2130	IDSR2130	3-3/8" - 4"	#13			●	●	●
IDR-2140	IDSR2140	4" - 5"	#14			●	●	●
IDR-2150	IDSR2150	5" - 6-1/4"	#15			●	●	●
IDR-2160	IDSR2160	6" - 10-1/4"	#16			●	●	●



BRAZED TOOLS

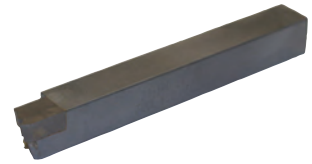
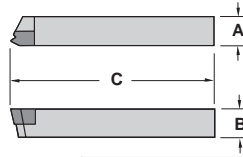

Description	EDP Code	TPI	TPF	Dimensions (mm)			Conn No or Size	CSH
				A	B	C		
B8 8RD EXT	77332E	8	3/4	12.70	12.70	101.60	-	●
B8 8RD INT	77332I	8	3/4	12.70	12.70	101.60	-	●
B8 10RD EXT	77334E	10	3/4	12.70	12.70	101.60	-	●
B8 10RD INT	77334I	10	3/4	12.70	12.70	101.60	-	●
B8 425 EXT	77309E	4	2	12.70	12.70	88.90	5-1/2 - 6-5/8 FH, 6-5/8 REG	
B8 425 INT	77309I	4	2	12.70	12.70	88.90	5-1/2 - 6-5/8 FH, 6-5/8 REG	
B8 428 EXT	77310E	4	2	12.70	12.70	88.90	NC23 - 50, 2-3/8 - 5-1/2 IF	
B8 428 INT	77310I	4	2	12.70	12.70	88.90	NC23 - 50, 2-3/8 - 5-1/2 IF	
B8 435 EXT	77311E	4	3	12.70	12.70	88.90	5-1/2 REG, 7-5/8 REG, 8-5/8 REG	
B8 435 INT	77311I	4	3	12.70	12.70	88.90	5-1/2 REG, 7-5/8 REG, 8-5/8 REG	
B8 438 EXT	77312E	4	3	12.70	12.70	88.90	NC56 - NC71	
B8 438 INT	77312I	4	3	12.70	12.70	88.90	NC56 - NC71	
B8 42F EXT*	77314E	4	2	12.70	12.70	88.90	VO.065*	
B8 42F INT*	77314I	4	2	12.70	12.70	88.90	VO.065*	
B8 530 EXT	77313E	5	3	12.70	12.70	88.90	3-1/2FH, 2-3/8 - 4-1/2 REG	
B8 530 INT	77313I	5	3	12.70	12.70	88.90	3-1/2FH, 2-3/8 - 4-1/2 REG	
B8 5B75 EXT	77316E	5	3/4	12.70	12.70	88.90	4-1/2 - 13-3/8	
B8 5B75 INT	77316I	5	3/4	12.70	12.70	88.90	4-1/2 - 13-3/8	
B8 5B1 EXT	77317E	5	1	12.70	12.70	88.90	16 AND LARGER	
B8 5B1 INT	77317I	5	1	12.70	12.70	88.90	16 AND LARGER	
B8 8B75 EXT	77321E	8	3/4	12.70	12.70	88.90	U.S. IMPROVED BUTTRESS	
B8 8B75 INT	77321I	8	3/4	12.70	12.70	88.90	U.S. IMPROVED BUTTRESS	
B10 8RD EXT	77532E	8	3/4	15.88	15.88	101.60	-	●
B10 8RD INT	77532I	8	3/4	15.88	15.88	101.60	-	●
B10 10RD EXT	77534E	10	3/4	15.88	15.88	101.60	-	●
B10 10RD INT	77534I	10	3/4	15.88	15.88	101.60	-	●
B10 425 EXT	77509E	4	2	15.88	15.88	88.90	5-1/2 - 6-5/8 FH, 6-5/8 REG	
B10 425 INT	77509I	4	2	15.88	15.88	88.90	5-1/2 - 6-5/8 FH, 6-5/8 REG	
B10 428 EXT	77510E	4	2	15.88	15.88	88.90	NC23 - 50, 2-3/8 - 5-1/2 IF	
B10 428 INT	77510I	4	2	15.88	15.88	88.90	NC23 - 50, 2-3/8 - 5-1/2 IF	
B10 435 EXT	77511E	4	3	15.88	15.88	88.90	5-1/2 REG, 7-5/8 REG, 8-5/8 REG	
B10 435 INT	77511I	4	3	15.88	15.88	88.90	5-1/2 REG, 7-5/8 REG, 8-5/8 REG	
B10 438 EXT	77512E	4	3	15.88	15.88	88.90	NC56 - NC71	
B10 438 INT	77512I	4	3	15.88	15.88	88.90	NC56 - NC71	
B10 42F EXT*	77514E	4	2	15.88	15.88	88.90	VO.065*	
B10 42F INT*	77514I	4	2	15.88	15.88	88.90	VO.065*	
B10 530 EXT	77513E	5	3	15.88	15.88	88.90	3-1/2FH, 2-3/8 - 4-1/2 REG	
B10 530 INT	77513I	5	3	15.88	15.88	88.90	3-1/2FH, 2-3/8 - 4-1/2 REG	
B10 5B75 EXT	77516E	5	3/4	15.88	15.88	88.90	4-1/2 - 13-3/8	
B10 5B75 INT	77516I	5	3/4	15.88	15.88	88.90	4-1/2 - 13-3/8	
B10 5B1 EXT	77517E	5	1	15.88	15.88	88.90	16 AND LARGER	
B10 5B1 INT	77517I	5	1	15.88	15.88	88.90	16 AND LARGER	
B10 8B75 EXT	77521E	8	3/4	15.88	15.88	88.90	U.S. IMPROVED BUTTRESS	
B10 8B75 INT	77521I	8	3/4	15.88	15.88	88.90	U.S. IMPROVED BUTTRESS	

* Obsolete thread form, See A.P.I. Spec 7, 35th Edition, May 1, 1995, Section 9.4

Cross Reference Chart

TOOL-FLO	VALENITE®	CARBOLOY®	VARDEX®	ISCAR®	TGI®	KENNAMETAL®
L43	TNEM 43					
LDS 43	TNEG 43					
L53						
LDS 54	TNEG 54					
LDS 54 - FT	TNEGX 54					
TNMC	TNEC/TNMC					
TNFA	TNFA					
16ER		16ER	3ER	16ER		
16NR		16NR	3IR	16IR		
22ER		22ER	4ER	22ER		
22NR		22NR	4IR	22IR		
27ER		27ER	5ER	27ER		
27NR		27NR	5NR	27IR		
V84					LCE/LPE 444	
V85					LCE/LPE 454	
FLD						ND
FLDC						NDC
FLTC						NTC



BRAZED TOOLS

Acme Threading
NO PITCH

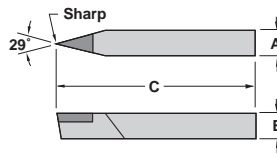

Description	EDP Code	TPI	Dimensions (mm)			C5H
			A	B	C	
B6 NT NO PITCH	77104A	6-16	9.53	9.53	63.50	●
B8 NT NO PITCH	77304A	4-16	12.70	12.70	88.90	●
B10 NT NO PITCH	77504A	2-16	15.88	15.88	101.60	●
B12 NT NO PITCH	77604A	2-16	19.05	19.05	114.30	●

Ring Grooving
NO PITCH

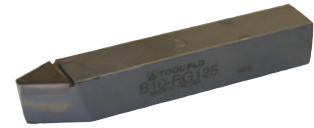
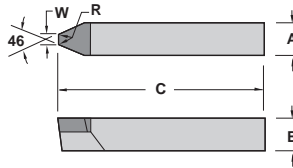

Description	EDP Code	Dimensions (mm)					Conn No or Size	C5H
		W	R	A	B	C		
B10 RG125	77506V	3.18	0.79	15.88	15.88	101.60	R19, 20, 22, 25, 29, 33, 36, 40, 43, 48, 52, 56, 59, 64, 68, 72 & 76	●
B12 RG156	77706W	3.96	0.79	19.05	19.05	127.00	RX210	●
B64 RG197	77806X	5.00	0.79	19.05	25.40	152.40	R21, 23, 24, 27, 30, 31, 34, 35, 37, 39, 41, 44, 45, 49, 53, 57, 61, 65, 69, 84, 92, 99 & RX-215	●
B85 RG197	77906X	5.00	0.79	25.40	31.75	177.80	R21, 23, 24, 27, 30, 31, 34, 35, 37, 39, 41, 44, 45, 49, 53, 57, 61, 65, 69, 84, 92, 99 & RX-215	●
B64 RG206	77806Y	5.23	1.59	19.05	25.40	152.40	R26, 32, 46, 73 & 85	●
B85 RG206	77906Y	5.23	1.59	25.40	31.75	177.80	R26, 32, 46, 73 & 85	●
B86 RG278	77907C	7.06	1.59	25.40	38.10	203.20	BX-151	●
B86 RG350	77907Z	8.89	1.59	25.40	38.10	203.20	BX-154	●

* See page 21 for ring groove specs.

In an effort to improve our stock standard grade offering, there are periodic changes. Please see current price list for up to date grade offering.

Cast Iron	
Non-Ferrous	
Stainless/High Temp	
Steel	

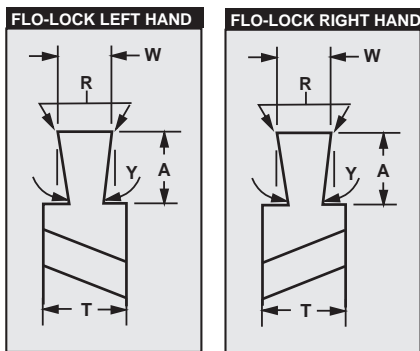

*We welcome specials!
Please call us with your specs.*

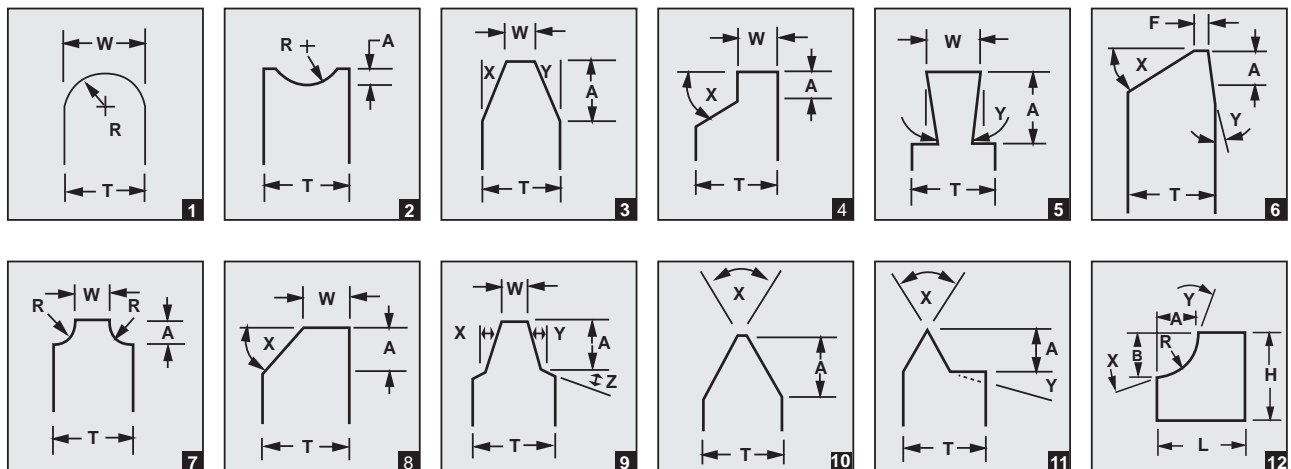



Rotary Shoulder Connections

thread form	Tool-Flo insert		tool joint application	minimum box size
	cresting	non-cresting		
V-.038R 2" tpf 4 tpi	22ER/NR 428 27ER/NR 428 FLDC-4-428 E/I L53 428 L43 428 LDS 54 428 TNMA/C 55 428 V85 428	FLD-3038R/L TNMA/C 54 NV .038R	2-3/8 API Internal Flush 2-7/8 API Internal Flush 3-1/2 API Internal Flush 4 API Internal Flush 4-1/2 API Internal Flush 5-1/2 API Internal Flush 4 API Full Hole NC23 NC26 NC31 NC35 NC38 NC40 NC44 NC46 NC50	NC31 2-7/8 IF
V-.038R 4 tpi	22ER/NR 438 3" tpf FLDC-4-438 E/I L53 438 L43 438 LDS 54 438 TNMA/C 55 438 V85 438	FLD-3038R/L 27ER/NR 438	NC56 TNMA/C 54 NV .038R NC70 NC77	NC61 NC56
V-.050 2" tpf 4 tpi	27ER/NR 425 FLDC-4-425 E/I LDS 54 425	FLD-4050R/L TNMA/C 54 NV .025R	5-1/2 API Full Hole 6-5/8 API Regular 6-5/8 API Full Hole	5-1/2 API Full Hole
V-.050 3" tpf 4 tpi	22ER/NR 435 FLDC-4-435 E/I LDS 54 435	FLD-4050R/L TNMA/C 54 NV .025R	5-1/2 API Regular 7-5/8 API Regular 8-5/8 API Regular	5-1/2 API Regular
V-.040 3" tpf 5 tpi	22ER/NR 530 FLDC-3-530 E/I FLDC-4-530 E/I LDS 54 530	FLD-3040R/L FLD-4040R/L TNMA/C 54 NV .020R	2-3/8 API Regular 2-7/8 API Regular 3-1/2 API Regular 4-1/2 API Regular 3-1/2 API Full Hole 4-1/2 API Full Hole	3-1/2 API Regular

API NC SPECIFICATIONS				
Conn. No. of Size	Thread Form	TPI	TPF	Cat. No.
NC10	V-0.055	6	1-1/2	VO.055
NC12	V-0.055	6	1-1/2	VO.055
NC13	V-0.055	6	1-1/2	VO.055
NC16	V-0.055	6	1-1/2	VO.055
NC23	V-0.038	4	2	428
NC26	V-0.038	4	2	428
NC31	V-0.038	4	2	428
NC35	V-0.038	4	2	428
NC38	V-0.038	4	2	428
NC40	V-0.038	4	2	428
NC44	V-0.038	4	2	428
NC46	V-0.038	4	2	428
NC50	V-0.038	4	2	428
NC56	V-0.038	4	3	438
NC61	V-0.038	4	3	438
NC70	V-0.038	4	3	438
NC71	V-0.038	4	3	438

API REGULAR SPECIFICATIONS					
Conn. No. of Size	Thread Form	TPI	TPF	Cat. No.	
1, 1-1/2 REG	V0.055	6	1-1/2	MT	
2-3/8 REG.	V-0.040	5	3	530	
2-7/8 REG.	V-0.040	5	3	530	
3-1/2 REG.	V-0.040	5	3	530	
4-1/2 REG.	V-0.040	5	3	530	
5-1/2 REG.	V-0.050	4	3	435	
6-5/8 REG.	V-0.050	4	2	425	
7-5/8 REG.	V-0.050	4	3	435	
8-5/8 REG.	V-0.050	4	3	435	

API FULL HOLE SPECIFICATIONS					
Conn. No. of Size	Thread Form	TPI	TPF	Cat. No.	
3-1/2 FH	V-0.040	5	3	530	
4 FH	V-0.038	4	2	428	
4-1/2 FH	V-0.040	5	3	530	
5-1/2 FH	V-0.050	4	2	425	
6-5/8 FH	V-0.050	4	2	425	

API INTERNAL FLUSH SPECIFICATIONS					
Conn. No. of Size	Thread Form	TPI	TPF	Cat. No.	
2-3/8 IF	V-0.038	4	2	428	
2-7/8 IF	V-0.038	4	2	428	
3-1/2 IF	V-0.038	4	2	428	
4 IF	V-0.038	4	2	428	
5-1/2 IF	V-0.038	4	2	428	

API THREAD FORM SPECIFICATIONS						
Thread Form	TPI	TPF	Width or Flat Crest	Root Radius	Cat. No.	
V-0.038	4	2	1.651	-	0.965 428	
V-0.038	4	3	1.651	-	0.965 438	
V-0.040	5	3	1.016	-	0.508 530	
V-0.050	4	3	1.270	-	0.635 435	
V-0.050	4	2	1.270	-	0.635 425	
V-0.065*	4	2	1.651	1.422	- 42F*	
V-0.076	4	1-1/2	1.930	1.702	- 4PAC	
V-0.055	6	1-1/2	1.397	1.194	- VO.055	

*Obsolete thread form - See API Spec 7, 35th Edition, May 1, 1985, Section 9.4

PRODUCT THREAD DIMENSIONS (mm) - ROTARY SHOULDER CONNECTIONS

thread form	taper in. per ft.	thread height not truncated H (mm)	thread height truncated $h_n = h_s$ (mm)	root truncation $S_m = S_{rs}$ $f_m = f_{rs}$ (mm)	crest truncation $f_{cn} = f_{cs}$ (mm)	width of flat		root radius $r_m = r_{rs}$ (mm)	radius at thread corners r (mm)	pitch p (mm)
						crest $f_{cn} = f_{cs}$ (mm)	crest $f_m = f_{rs}$ (mm)			
V-038R	2	5.4865	3.0948	0.9652	1.4265	1.6510	-	0.9652	0.3810	6.3500
V-038R	3	5.4706	3.0831	0.9652	1.4223	1.6510	-	0.9652	0.3810	6.3500
V-040	3	4.3764	2.9932	0.5080	0.8753	1.0160	-	0.5080	0.3810	5.0800
V-050	3	5.4706	3.7415	0.6350	1.0941	1.2700	-	0.6350	0.3810	6.3500
V-050	2	5.4865	3.7542	0.6350	1.0973	1.2700	-	0.6350	0.3810	6.3500

V-040 AND V-050 PRODUCT THREAD FORM

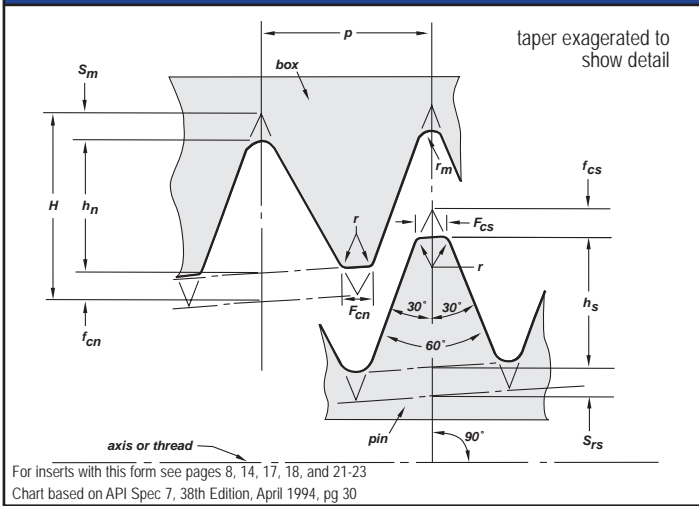

API BUTTRESS

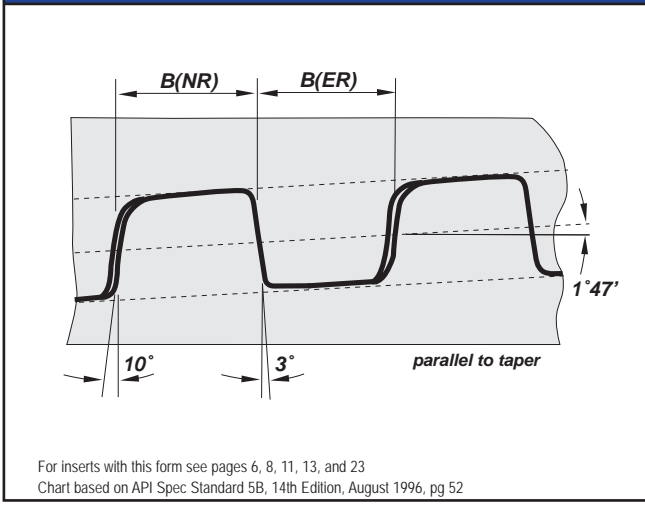

API CASING AND TUBING ROUND THREAD FORM

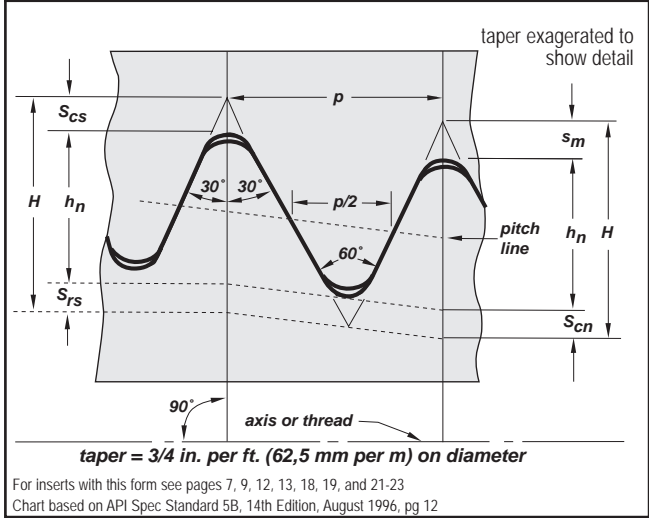

AMERICAN NATIONAL PIPE THREAD (NPT)

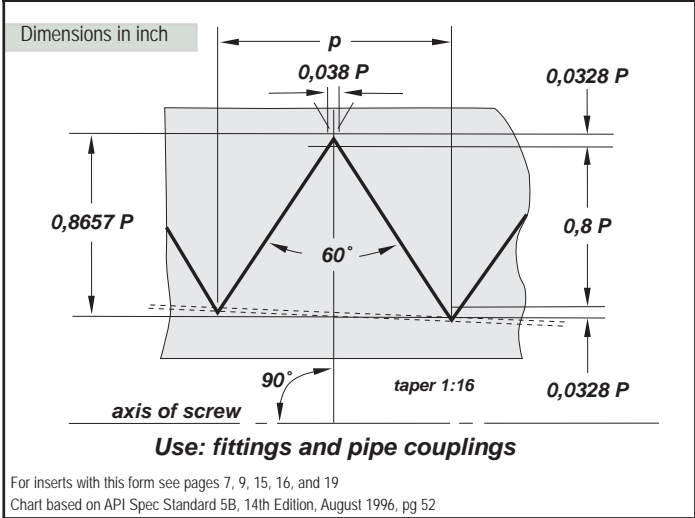

CASING AND TUBING ROUND THREAD (Height Dimensions-mm)

thread element		10 threads per inch $p=2.54$	8 threads per inch $p=3.175$	
H	=	21.99p	2.1996	2.7496
$H_s = h_n$	=	15.90p - .1778	1.4122	1.8098
$S_{rs} = S_m$	=	3.048p + .0508	0.3556	0.4318
$S_{cs} = S_{cn}$	=	3.048p + .1270	0.4318	0.5080

NPT PIPE SIZE CROSSOVER

pipe size	NPT thread per inch
1/16", 1/8"	27 NPT
1/4", 3/8"	18NPT
1/2", 3/4"	14 NPT
1" - 2"	11.5 NPT
2-1/2" and up	8 NPT

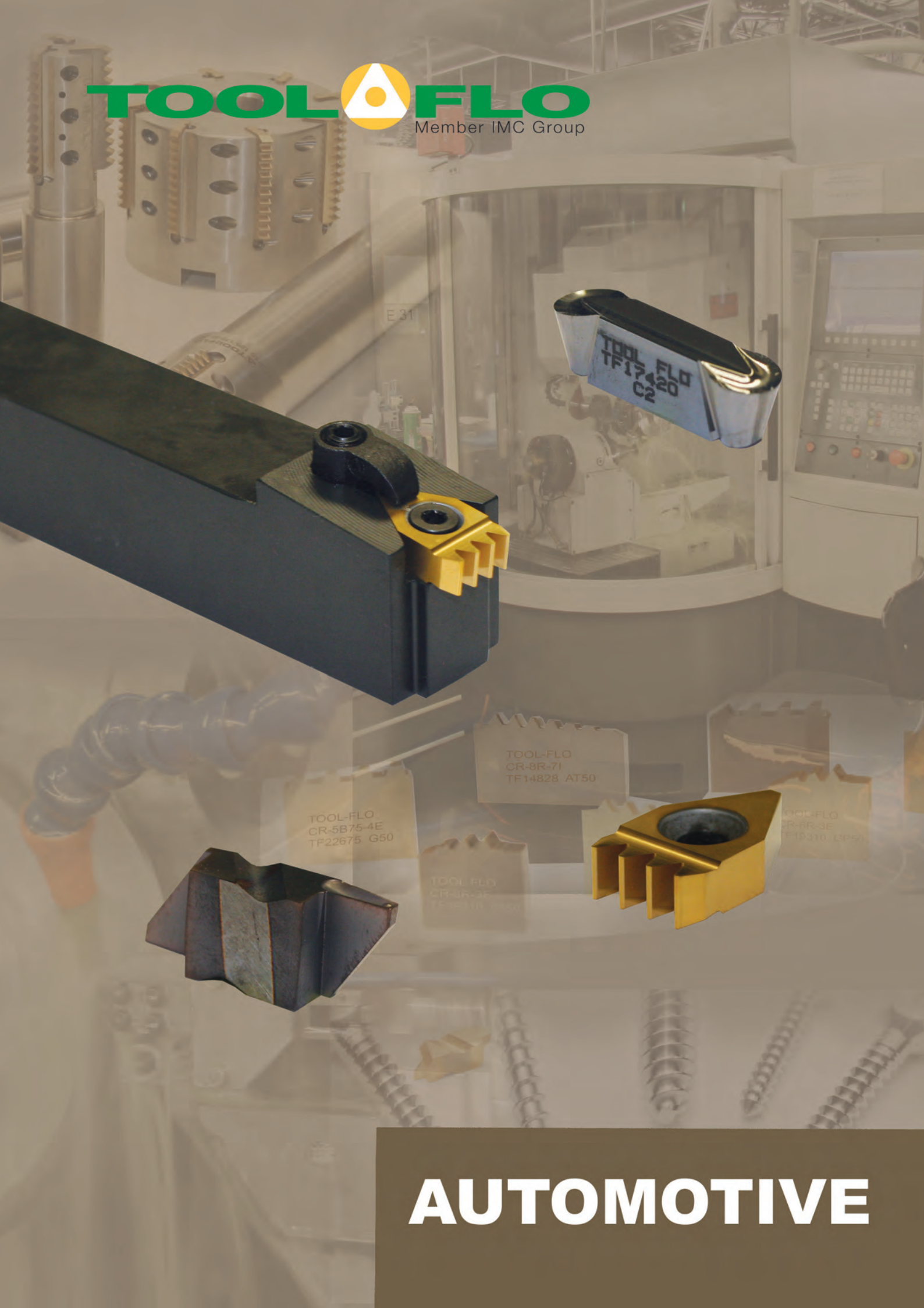

AUTOMOTIVE



Poly-Vee Insert Identification Chart

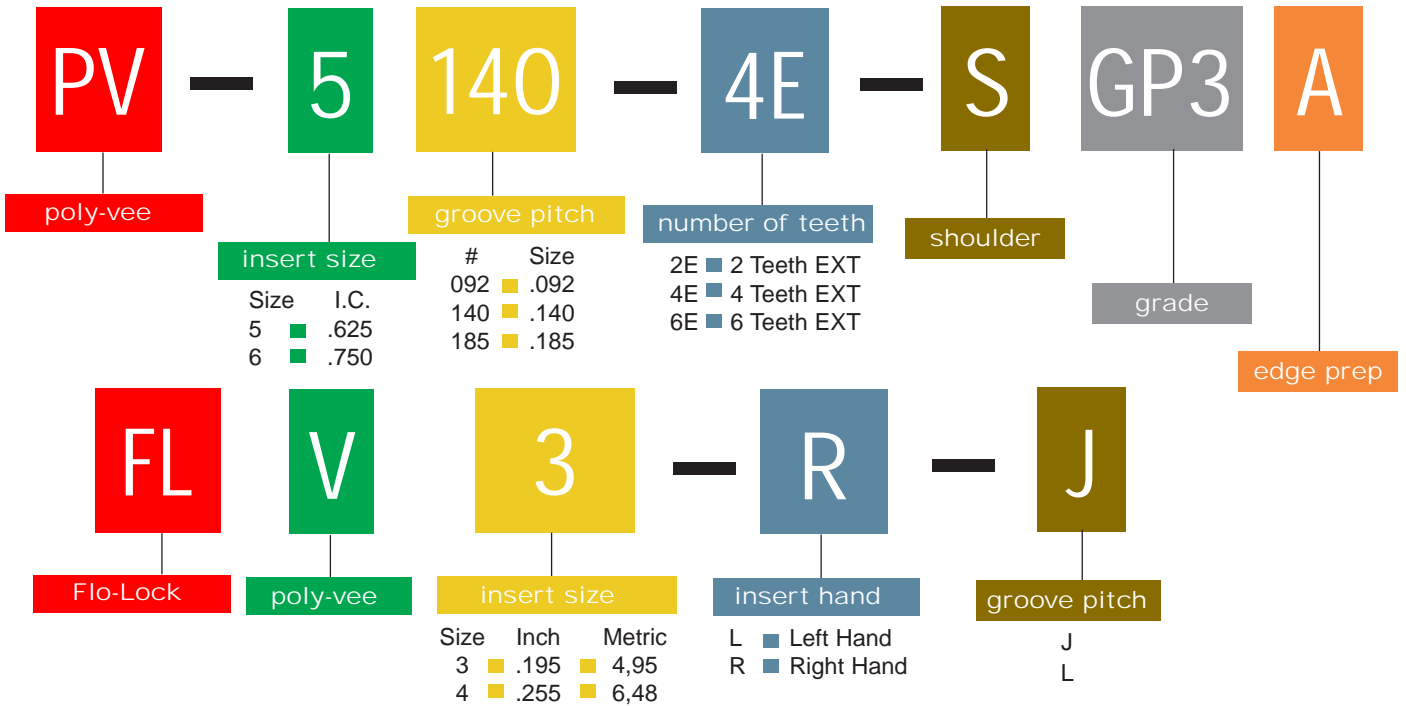

- PV**
- Multi-tooth inserts for faster cycle times
 - Inserts are precision ground for premium tolerance
 - Strong cutting edge able to withstand moderate interruption
- PV-S**
- Multi-tooth inserts for faster cycle times
 - Inserts are precision ground for premium tolerance
 - Strong cutting edge able to withstand moderate interruption
 - Shoulder configuration produces more finished grooves per plunge

- FLV**
- Single-point insert for flexible programming
 - Inserts are precision ground for premium tolerance
 - Strong cutting edge able to withstand moderate interruption
 - Fits into industry standard holders

POLY-VEE

PV-S Multi-Tooth w/ Shoulder

■ For holder STCNR see next page

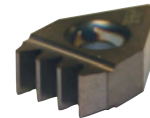
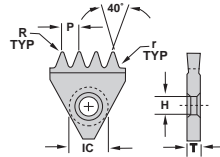
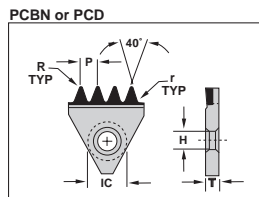

Insert Description	EDP Code	Cross Section*	IC	Dimensions (mm)						# of teeth	Coatings					
				H	T	P	r	R	C25		GP25	AC25	AC3	AC50	CB200	PC33
PV-5092-4E-S	PV50924ES	J	5/8	5.16	6.40	2.34	0.20	0.30	4	●	●	●	●	●	●	●
PV-5092-6E-S	PV50926ES	J	5/8	5.16	6.40	2.34	0.20	0.30	6	●	●	●	●	●	●	●
PV-5140-2E-S	PV51402ES	K	5/8	5.16	6.40	3.56	0.33	0.41	2	●	●	●	●	●	●	●
PV-5140-4E-S	PV51404ES	K	5/8	5.16	6.40	3.56	0.33	0.41	4	●	●	●	●	●	●	●
PV-6140-6E-S	PV61406ES	K	5/8	5.16	6.35	3.56	0.33	0.41	6	●	●	●	●	●	●	●
PV-6185-4E-S	PV61854ES	L	5/8	5.16	6.35	4.70	0.53	0.33	4	●	●	●	●	●	●	●

PV Multi-Tooth w/o Shoulder

■ For holder STCNR see next page

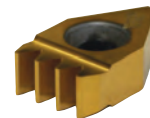
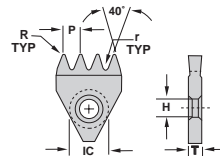
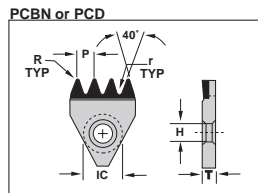

Insert Description	EDP Code	Cross Section*	IC	Dimensions (mm)						# of teeth	Coatings					
				H	T	P	r	R	C25		GP25	AC25	AC3	AC50	CB200	PC33
PV-5092-4E	PV50924E	J	5/8	5.16	6.40	2.34	0.20	0.30	4	●	●	●	●	●	●	●
PV-5092-6E	PV50926E	J	5/8	5.16	6.40	2.34	0.20	0.30	6	●	●	●	●	●	●	●
PV-5140-2E	PV51402E	K	5/8	5.16	6.40	3.56	0.33	0.41	2	●	●	●	●	●	●	●
PV-5140-4E	PV51404E	K	5/8	5.16	6.40	3.56	0.33	0.41	4	●	●	●	●	●	●	●
PV-6140-6E	PV61406E	K	3/4	5.16	6.35	3.56	0.33	0.41	6	●	●	●	●	●	●	●
PV-6185-4E	PV61854E	L	3/4	5.16	6.35	4.70	0.53	0.33	4	●	●	●	●	●	●	●

*See table on page.

In an effort to improve our stock standard grade offering, there are periodic changes. Please see current price list for up-to-date grade offering.

- High performance choice in optimal conditions.
- ▲ Recommended grade under general conditions.

Material	GP25	AC25	AC3	AC50	CB200	PC33
Cast Iron	●	●	●	●	●	●
Non-Ferrous	●	●	●	●	●	●
Stainless/High Temp	●	●	●	●	●	●
Steel	●	●	●	●	●	●



AUTOMOTIVE

AUTOMOTIVE

POLY-VEE STCNR

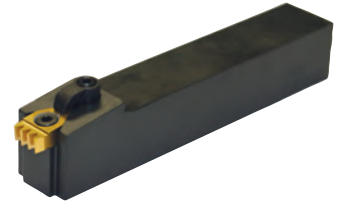
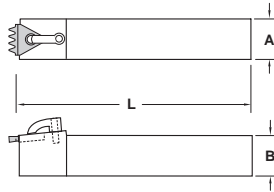

Description	EDP Code	Dimensions (mm)			Insert	Insert Screw	Clamp	Clamo Screw
		A	B	L				
STCNR-25M5	977025M4641	25.00	25.00	150.00	PV-5_	SD-2	CLM-20	STCM11
STCNR-32M5	977032M6641	32.00	32.00	150.00	PV-5_	SD-2	CLM-20	STCM11
STCNR-32M6	977032M6761	32.00	32.00	150.00	PV-6_	SD-2	CLM-20	STCM11

POLY-VEE FLO-LOCK FLV

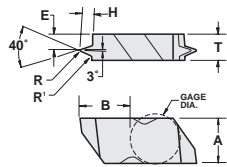

RH Shown

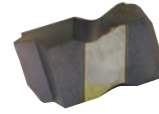

Insert Description	EDP Code	Dimensions (mm)								Coatings				
		R	R1	T	E	H	A	B	C25	GP3	GP50	AC3	AC50	
FLV-3RJ	623800R	0.30	0.20	4.95	3.18	2.21	8.74	10.19	●	●	●	●	●	
FLV-3RK	623900R	0.41	0.33	4.95	2.54	3.45	8.74	10.16	●	●	●	●	●	
FLV-4RL	624800R	0.30	0.38	6.48	3.00	5.11	11.51	15.97	●	●	●	●	●	
FLV-3LJ	623800L	0.30	0.20	4.95	3.18	2.21	8.74	10.19	●	●	●	●	●	
FLV-3LK	623900L	0.41	0.33	4.95	2.54	3.45	8.74	10.16	●	●	●	●	●	
FLV-4LL	624800L	0.30	0.38	6.48	3.00	5.11	11.51	15.97	●	●	●	●	●	

PISTON GROOVING KEYSTONE FLG

Chipbreaker

Exclusive patented design!

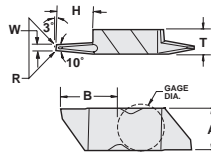

RH Shown



Insert Description	EDP Code	Dimensions (mm)						Coatings				
		W	R	H	T	A	B	C25	GP3	GP50	AC3	AC50
FLG-4R W.059 TF19908	TF19908	1.50	0.30	6.99	6.48	11.51	15.97	●	●	●	●	●

GROOVING CHIP-FLO FLG-CB

Chipbreaker

Exclusive patented design!

See page 85 for a complete listing!

- Features:
- Patented chipbreaker - Patent No. 6,146,064
 - Maximum chip control
 - Industry standard widths

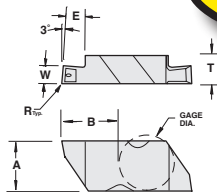

RH Shown

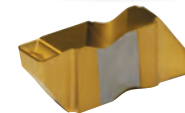

Insert Description	EDP Code	Dimensions (mm)								Coatings					
		W	R	E	T	A	B	Gage Dia.	C3	GP3	GP50	AC3	AC50	AC22	
FLG-2M100R-CB	562M100PR	1.00	0.13/0.25	1.90	3.81	5.56	6.86	4.76	●	●	●	●	●	●	
FLG-2M100L-CB	562M100PL	1.00	0.13/0.25	1.90	3.81	5.56	6.86	4.76	●	●	●	●	●	●	
FLG-2M150R-CB	562M150PR	1.50	0.13/0.25	2.79	3.81	5.56	6.86	4.76	●	●	●	●	●	●	
FLG-2M150L-CB	562M150PL	1.50	0.13/0.25	2.79	3.81	5.56	6.86	4.76	●	●	●	●	●	●	
FLG-2M170R-CB	562M170PR	1.70	0.13/0.25	2.79	3.81	5.56	6.86	4.76	●	●	●	●	●	●	
FLG-2M170L-CB	562M170PL	1.70	0.13/0.25	2.79	3.81	5.56	6.86	4.76	●	●	●	●	●	●	
FLG-2M195R-CB	562M195PR	1.95	0.13/0.25	2.79	3.81	5.56	6.86	4.76	●	●	●	●	●	●	
FLG-2M195L-CB	562M195PL	1.95	0.13/0.25	2.79	3.81	5.56	6.86	4.76	●	●	●	●	●	●	
FLG-2M200R-CB	562M200PR	2.00	0.13/0.25	2.79	3.81	5.56	6.86	4.76	●	●	●	●	●	●	
FLG-2M200L-CB	562M200PL	2.00	0.13/0.25	2.79	3.81	5.56	6.86	4.76	●	●	●	●	●	●	
FLG-2M220R-CB	562M220PR	2.20	0.13/0.25	2.79	3.81	5.56	6.86	4.76	●	●	●	●	●	●	
FLG-2M220L-CB	562M220PL	2.20	0.13/0.25	2.79	3.81	5.56	6.86	4.76	●	●	●	●	●	●	
FLG-2M225R-CB	562M225PR	2.25	0.13/0.25	2.79	3.81	5.56	6.86	4.76	●	●	●	●	●	●	
FLG-2M225L-CB	562M225PL	2.25	0.13/0.25	2.79	3.81	5.56	6.86	4.76	●	●	●	●	●	●	
FLG-2M250R-CB	562M250PR	2.50	0.13/0.25	2.79	3.81	5.56	6.86	4.76	●	●	●	●	●	●	
FLG-2M250L-CB	562M250PL	2.50	0.13/0.25	2.79	3.81	5.56	6.86	4.76	●	●	●	●	●	●	

In an effort to improve our stock standard grade offering, there are periodic changes. Please see current price list for up to date grade offering.

- High performance choice in optimal conditions.
- ▲ Recommended grade under general conditions.

Cast Iron	▲	●	▲
Non-Ferrous	●		
Stainless/High Temp	▲	●	▲
Steel		▲	▲

Available in PCD!
Any width or configuration!
Call us with your piston grooving needs!

TNMA
TNMC
FLG



WHEEL TURNING

DBV

High Polish

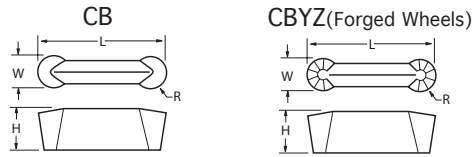

Insert Description	EDP Code	Dimensions (mm)				C2P	ALS2	AC3	AC50
		W	R	L	H				
DBV-315 FNR-CB	TF17420	8.00	3.99	29.97	8.13	●	●		
DBV-315 FNR-CBYZ	TF22487	8.00	3.99	29.97	8.13	●	●		
In an effort to improve our stock standard grade offering, there are periodic changes. Please see current price list for up to date grade offering.						● High performance choice in optimal conditions. ▲ Recommended grade under general conditions.		Aluminum	▲
								Steel	●

WHEEL TURNING

TFHDR/L

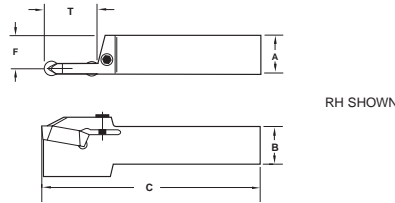

Description	EDP Code	Insert	Dimensions (mm)					Screw
			T	A	B	C	F	
TFHDRM-25.4-8	9828M258	DBV	25.00	25.00	25.00	150.00	22.45	TS-61
TFHDLM-25.4-8	9827M258	DBV	25.00	25.00	25.00	150.00	22.45	TS-61
TFHDRM-31.7-8	9828M328	DBV	25.00	32.00	32.00	170.00	28.78	TS-61
TFHDLM-31.7-8	9827M328	DBV	25.00	32.00	32.00	170.00	28.78	TS-61

POLY-VEE TECHNICAL INFORMATION

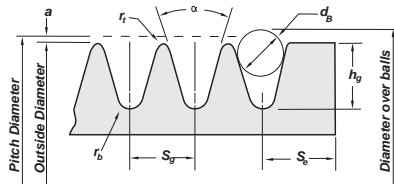

Face width = $S_e (N_g - 1) + 2S_e$, where N_g is number of grooves

Cross Section	Minimum Recommended Outside Diameter	Groove Angle ± 6.35 (deg)	S_g^a	r_1 + 0.027 - 0.000	2_a	r_b	h_g (mm)	d_b ± 0.0127	S_e
H	12.70	40	1.600 ± 0.025	0.127	0.508	0.330 + 0.000 - 0.127	1.041	1.191	2.032 + 0.508 - 0.254
J	20.32	40	2.337 ± 0.025	0.203	0.762	0.381 + 0.000 - 0.127	1.803	1.589	3.175 + 0.762 - 0.381
K	38.10	40	3.556 ± 0.051	0.254	0.965	0.508 + 0.000 - 0.127	3.099	2.776	3.175 + 1.270 - 0.000
L	76.20	40	4.699 ± 0.051	0.381	1.473	0.381 + 0.000 - 0.127	4.648	3.571	9.525 + 1.905 - 0.762
M	177.80	40	9.398 ± 0.076	0.762	2.946	0.762 + 0.000 - 0.254	9.576	7.142	12.700 + 2.540 - 1.016

Other Sheave Tolerances

Outside Diameter	Radial Runout	Axial Runout
Up through 73.66 mm outside diameter ± 0.254 mm. Over 73.66 mm to and including 203.20 mm outside diameter ± 0.508 mm. For each additional mm of outside diameter over 203.20 mm add ± 0.635 mm.	Up through 73.66 mm outside diameter ± 0.127 mm. Over 73.66 mm to and including 254.00 mm. outside diameter ± 0.254 mm. For each additional mm of outside diameter over 254.0 mm, add 0.0127 mm.	0.0254 mm per mm of outside diameter

All dimensions in mm.

^aSummation of the deviations from S for all groovers in any one sheave shall not exceed ± 0.254 mm.

^bVariations in pitch diameter between groovers in any one sheave must be within the following limits: Up through 73.66 mm. outside diameter and up through 6 grooves, 0.051 mm. (add 0.0254 mm for each additional groove); over 73.66 mm to and including 505.46 mm and up through 10 grooves, 0.254 mm (add 0.0127 mm for each additional groove.) This variation can be obtained by measuring the distance across two measuring balls or rods placed in the grooves diametrically opposite each other. Comparing this "diameter-over-balls or -rods" measurement between grooves will give the variation in pitch diameter.

^cTotal indicator reading.



BALL NOSE

End Mills



Ball Nose End Mills

RIGID-LOCK

SERRATED LOCKING SYSTEM

Rigid-Lock Ball Nose Cutter Nomenclature Chart

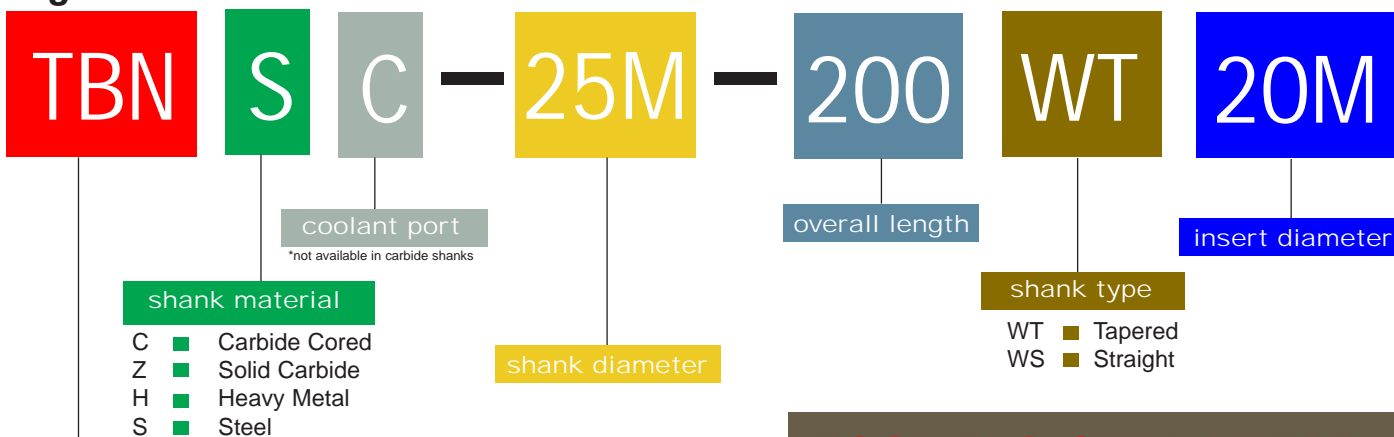

TOOL-FLO GUARANTEE

All above endmills feature our patented **RIGID-LOCK** serrated locking system. Precision ground serrations provide increased stability in the pocket and allow for increased speeds/feeds while preventing insert movement in the pocket.

No insert movement means longer insert life as well as longer cutter body life. **Tool-Flo Mfg will replace any cutter body that experiences pocket wear***

*excludes insert screw wear, or tools that have been crashed.

TBNR-M-N Neutral Rake - Finishing Insert

Cutter: TBNSC/TBNS/TBNC

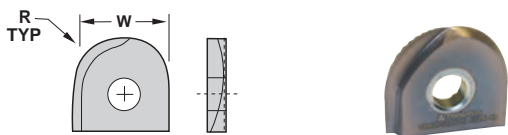

Insert Description	EDP Code	Dia	R	C26S	GP26	ZS26S	ZS26	AC3	DX200	PCD Coated	CBN Tipped*
TBNR-10M-N	TBNR10MN	10.0	5.0	●	●	●	●	●	●	●	●
TBNR-12M-N	TBNR12MN	12.0	6.0	●	●	●	●	●	●	●	●
TBNR-16M-N	TBNR16MN	16.0	8.0	●	●	●	●	●	●	●	●
TBNR-20M-N	TBNR20MN	20.0	10.0	●	●	●	●	●	●	●	●
TBNR-25M-N	TBNR25MN	25.0	12.5	●	●	●	●	●	●	●	●
TBNR-30M-N	TBNR30MN	30.0	15.0	●	●	●	●	●	●	●	●
TBNR-32M-N	TBNR32MN	32.0	16.0	●	●	●	●	●	●	●	●

*CBN tipped inserts must run in machine with head tilted at 5° minimum

TBNR-M-P Positive Rake - Finishing Insert

Cutter: TBNSC/TBNS/TBNC

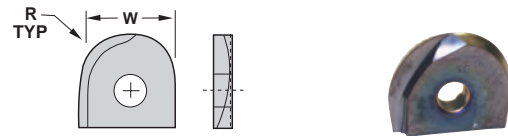

Insert Description	EDP Code	Dia	R	C26S	GP26	ZS26S	ZS26	AC3	DX200	PCD Coated	CBN Tipped*
TBNR-8M-P	TBNR8MP	8.0	4.0	●	●	●	●	●	●	●	●
TBNR-10M-P	TBNR10MP	10.0	5.0	●	●	●	●	●	●	●	●
TBNR-12M-P	TBNR12MP	12.0	6.0	●	●	●	●	●	●	●	●
TBNR-16M-P	TBNR16MP	16.0	8.0	●	●	●	●	●	●	●	●
TBNR-20M-P	TBNR20MP	20.0	10.0	●	●	●	●	●	●	●	●
TBNR-25M-P	TBNR25MP	25.0	12.5	●	●	●	●	●	●	●	●
TBNR-30M-P	TBNR30MP	30.0	15.0	●	●	●	●	●	●	●	●
TBNR-32M-P	TBNR32MP	32.0	16.0	●	●	●	●	●	●	●	●
TBNR-40M-P	TBNR40MP	40.0	20.0	●	●	●	●	●	●	●	●
TBNR-50M-P	TBNR50MP	50.0	25.0	●	●	●	●	●	●	●	●
TBNR-65M-P	TBNR65MP	65.0	32.5	●	●	●	●	●	●	●	●



BALLNOSE

TBXR-M-N

Neutral Rake - Roughing Insert

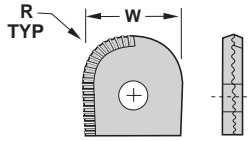

Special Design for Roughing!

Cutter: TBNSC/TBNS/TBNC

Insert Description	EDP Code	Dia	R	C26S	GP26	ZS26S	ZS26	AC3	DX200	CB200
TBXR-16M-N	TBXR16MN	16.0	8.0	●	●	●	●	●	●	●
TBXR-20M-N	TBXR20MN	20.0	10.0	●	●	●	●	●	●	●
TBXR-25M-N	TBXR25MN	25.0	12.5	●	●	●	●	●	●	●
TBXR-30M-N	TBXR30MN	30.0	15.0	●	●	●	●	●	●	●
TBXR-32M-N	TBXR32MN	32.0	16.0	●	●	●	●	●	●	●
TBXR-40M-N	TBXR40MN	40.0	20.0	●	●	●	●	●	●	●

BALLNOSE

SPHEROID STYLE

TBRR-M-P

Positive-Rake Finishing Insert

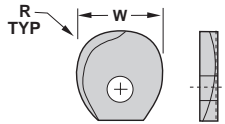

Cutter: TBNSC/TBNS/TBNC

Insert Description	EDP Code	Dia	R	Uncoated		TiN Coated		AlTiN Coated		PCD Coated		CBN Tipped*
				C26S	GP26	ZS26S	ZS26	AC3	DX200	CB200		
TBRR-8M-P	TBRR8MP	8.0	4.0	●	●	●	●	●	●	●	●	●
TBRR-10M-P	TBRR10MP	10.0	5.0	●	●	●	●	●	●	●	●	●
TBRR-12M-P	TBRR12MP	12.0	6.0	●	●	●	●	●	●	●	●	●
TBRR-16M-P	TBRR16MP	16.0	8.0	●	●	●	●	●	●	●	●	●
TBRR-20M-P	TBRR20MP	20.0	10.0	●	●	●	●	●	●	●	●	●
TBRR-25M-P	TBRR25MP	25.0	12.5	●	●	●	●	●	●	●	●	●
TBRR-30M-P	TBRR30MP	30.0	15.0	●	●	●	●	●	●	●	●	●
TBRR-32M-P	TBRR32MP	32.0	16.0	●	●	●	●	●	●	●	●	●

In an effort to improve our stock standard grade offering, there are periodic changes. Please see current price list for up-to-date grade offering.

- High performance choice in optimal conditions.
- ▲ Recommended grade under general conditions.

Cast Iron					●						
Non-Ferrous		▲			●						
Stainless/High Temp					●						
Steel					●						
Hardened Material							▲			●	
Composite							▲		●		

TBNS-WT

Tapered Neck Holder w/coolant port

Available in Steel, Carbide Cored & Heavy Metal.

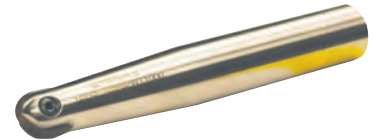
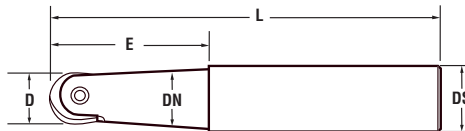

Size	Description	EDP Code	D	E	L	DS	DN	Insert	Screw	Wrench
16mm	TBNSC-20M-175WT16	TBNSC20M175WT16	16.0	60.0	175.0	20.0	3° Taper	TBNR/RR-16M	STBN-5	K3
20mm	TBNSC-25M-200WT20	TBNSC25M200WT20	20.0	80.0	200.0	25.0	3° Taper	TBNR/RR-20M	STBN-6	K4
25mm	TBNSC-32M-225WT25	TBNSC32M225WT25	25.0	100.0	225.0	32.0	3° Taper	TBNR/RR-25M	STBN-7	K5
30mm	TBNSC-40M-225WT30	TBNSC40M225WT30	30.0	120.0	225.0	40.0	3° Taper	TBNR/RR-30M	STBN-8	K6
32mm	TBNSC-40M-225WT32	TBNSC40M225WT32	32.0	120.0	225.0	40.0	3° Taper	TBNR/RR-32M	STBN-8	K6

Tapered Neck Holder without coolant port

Size	Description	EDP Code	D	E	L	DS	DN	Insert	Screw	Wrench
8mm	TBNS-10M-125WT8	TBNS10M125WT8	8.0	35.0	125.0	10.0	3° Taper	TBNR/RR-8M	STBN-2	K3
10mm	TBNS-12M-125WT10	TBNS12M125WT10	10.0	35.0	125.0	12.0	3° Taper	TBNR/RR-10M	STBN-3	K3
12mm	TBNS-16M-160WT12	TBNS16M160WT12	12.0	60.0	160.0	16.0	3° Taper	TBNR/RR-12M	STBN-4	K3
16mm	TBNS-20M-180WT16	TBNS20M180WT16	16.0	60.0	180.0	20.0	3° Taper	TBNR/RR-16M	STBN-5	K3
20mm	TBNS-25M-190WT20	TBNS25M190WT20	20.0	80.0	190.0	25.0	3° Taper	TBNR/RR-20M	STBN-6	K4
20mm	TBNS-25M-230WT20	TBNS25M230WT20	20.0	80.0	230.0	25.0	3° Taper	TBNR/RR-20M	STBN-6	K4
25mm	TBNS-32M-210WT25	TBNS32M210WT25	25.0	100.0	210.0	32.0	3° Taper	TBNR/RR-25M	STBN-7	K5
25mm	TBNS-32M-240WT25	TBNS32M240WT25	25.0	100.0	240.0	32.0	3° Taper	TBNR/RR-25M	STBN-7	K5
30mm	TBNS-40M-250WT30	TBNS40M250WT30	30.0	120.0	250.0	40.0	3° Taper	TBNR/RR-30M	STBN-8	K6
32mm	TBNS-40M-250WT32	TBNS40M250WT32	32.0	120.0	250.0	40.0	3° Taper	TBNR/RR-32M	STBN-8	K6



TBNC-WT

Tapered Neck Holder without coolant port

BALLNOSE

Carbide Cored Shank

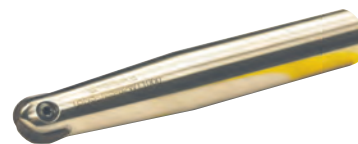
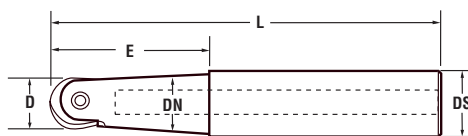

Size	Description	EDP Code	D	E	L	DS	DN	Insert	Screw	Wrench
16mm	TBNC-20M-180WT16	TBNC20M180WT16	16.0	60.0	180.0	20.0	3° Taper	TBNR/RR-16M	STBN-5	K3
20mm	TBNC-25M-190WT20	TBNC25M190WT20	20.0	80.0	190.0	25.0	3° Taper	TBNR/RR-20M	STBN-6	K4
20mm	TBNC-25M-230WT20	TBNC25M230WT20	20.0	80.0	230.0	25.0	3° Taper	TBNR/RR-20M	STBN-6	K4
25mm	TBNC-32M-210WT25	TBNC32M210WT25	25.0	100.0	210.0	32.0	3° Taper	TBNR/RR-25M	STBN-7	K5
25mm	TBNC-32M-240WT25	TBNC32M240WT25	25.0	100.0	240.0	32.0	3° Taper	TBNR/RR-25M	STBN-7	K5
30mm	TBNC-40M-250WT30	TBNC40M250WT30	30.0	120.0	250.0	40.0	3° Taper	TBNR/RR-30M	STBN-8	K6
32mm	TBNC-40M-250WT32	TBNC40M250WT32	32.0	120.0	250.0	40.0	3° Taper	TBNR/RR-32M	STBN-8	K6

TBNS-WS

Straight Neck Holder w/coolant port (RH only)

Available in Steel, Carbide Cored & Heavy Metal.

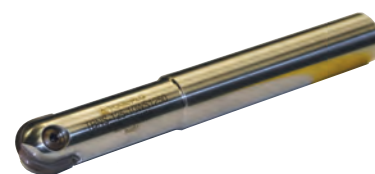
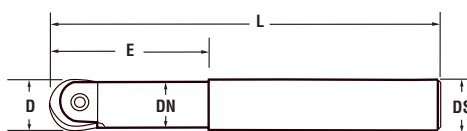

Size	Description	EDP Code	D	E	L	DS	DN	Insert	Screw	Wrench
20mm	TBNSC-20M-175WS20	TBNSC20M175WS20	20.0	45.0	175.0	20.0	18.0	TBNR/RR-20M	STBN-6	K4
25mm	TBNSC-25M-190WS25	TBNSC25M190WS25	25.0	70.0	190.0	25.0	23.0	TBNR/RR-25M	STBN-7	K5
32mm	TBNSC-32M-210WS32	TBNSC32M210WS32	32.0	80.0	210.0	32.0	27.2	TBNR/RR-32M	STBN-8	K6

Straight Neck Holder without coolant port (RH only)

Size	Description	EDP Code	D	E	L	DS	DN	Insert	Screw	Wrench
8mm	TBNS-8M-100WS8	TBNS8M100WS8	8.0	19.0	100.0	8.0	7.5	TBNR/RR-8M	STBN-2	K3
10mm	TBNS-10M-100WS10	TBNS10M100WS10	10.0	19.0	100.0	10.0	9.0	TBNR/RR-10M	STBN-3	K3
12mm	TBNS-12M-130WS12	TBNS12M130WS12	12.0	36.0	130.0	12.0	10.5	TBNR/RR-12M	STBN-4	K3
12mm	TBNS-12M-150WS12	TBNS12M150WS12	12.0	46.0	150.0	12.0	10.5	TBNR/RR-12M	STBN-4	K3
16mm	TBNS-16M-140WS16	TBNS16M140WS16	16.0	36.0	140.0	16.0	14.0	TBNR/RR-16M	STBN-5	K3
16mm	TBNS-16M-160WS16	TBNS16M160WS16	16.0	36.0	160.0	16.0	14.0	TBNR/RR-16M	STBN-5	K3
20mm	TBNS-20M-160WS20	TBNS20M160WS20	20.0	45.0	160.0	20.0	18.0	TBNR/RR-20M	STBN-6	K4
20mm	TBNS-20M-175WS20	TBNS20M175WS20	20.0	45.0	175.0	20.0	18.0	TBNR/RR-20M	STBN-6	K4
25mm	TBNS-25M-160WS25	TBNS25M160WS25	25.0	45.0	160.0	25.0	23.0	TBNR/RR-25M	STBN-7	K5
25mm	TBNS-25M-190WS25	TBNS25M190WS25	25.0	70.0	190.0	25.0	23.0	TBNR/RR-25M	STBN-7	K5
30mm	TBNS-30M-175WS30	TBNS30M175WS30	30.0	56.0	175.0	30.0	27.2	TBNR/RR-30M	STBN-8	K6
30mm	TBNS-30M-210WS30	TBNS30M210WS30	30.0	80.0	210.0	30.0	27.2	TBNR/RR-30M	STBN-8	K6
32mm	TBNS-32M-175WS32	TBNS32M175WS32	32.0	56.0	175.0	32.0	27.2	TBNR/RR-32M	STBN-8	K6
32mm	TBNS-32M-210WS32	TBNS32M210WS32	32.0	80.0	210.0	32.0	27.2	TBNR/RR-32M	STBN-8	K6
40mm	TBNS-40M-305WS40	TBNS40M305WS40	40.0	101.0	305.0	32.0	35.0	TBNR/RR-40M	STBN-8	K6
50mm	TBNS-50M-406WS50	TBNS50M406WS50	50.0	152.0	406.0	50.0	41.0	TBNR/RR-50M	STBN-9	K-7
65mm	TBNS-65M-406WS65	TBNS65M406WS65	65.0	152.0	406.0	65.0	54.0	TBNR/RR-65M	STBN-10	K-8

TBNC-WS

Straight Neck Holder without coolant port (RH only)

Carbide Cored Shank

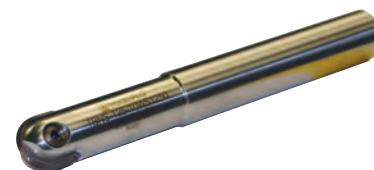
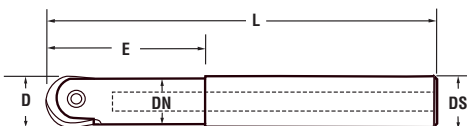

Size	Description	EDP Code	D	E	L	DS	DN	Insert	Screw	Wrench
12mm	TBNC-12M-130WS12	TBNC12M130WS12	12.0	36.0	130.0	12.0	10.5	TBNR/RR-12M	STBN-4	K3
12mm	TBNC-12M-150WS12	TBNC12M150WS12	12.0	46.0	150.0	12.0	10.5	TBNR/RR-12M	STBN-4	K3
16mm	TBNC-16M-140WS16	TBNC16M140WS16	16.0	36.0	140.0	16.0	14.0	TBNR/RR-16M	STBN-5	K3
16mm	TBNC-16M-160WS16	TBNC16M160WS16	16.0	36.0	160.0	16.0	14.0	TBNR/RR-16M	STBN-5	K3
20mm	TBNC-20M-160WS20	TBNC20M160WS20	20.0	45.0	160.0	20.0	18.0	TBNR/RR-20M	STBN-6	K4
20mm	TBNC-20M-175WS20	TBNC20M175WS20	20.0	45.0	175.0	20.0	18.0	TBNR/RR-20M	STBN-6	K4
25mm	TBNC-25M-160WS25	TBNC25M160WS25	25.0	45.0	160.0	25.0	23.0	TBNR/RR-25M	STBN-7	K5
25mm	TBNC-25M-190WS25	TBNC25M190WS25	25.0	70.0	190.0	25.0	23.0	TBNR/RR-25M	STBN-7	K5
30mm	TBNC-30M-175WS30	TBNC30M175WS30	30.0	56.0	175.0	30.0	27.2	TBNR/RR-30M	STBN-8	K6
30mm	TBNC-30M-210WS30	TBNC30M210WS30	30.0	80.0	210.0	30.0	27.2	TBNR/RR-30M	STBN-8	K6
32mm	TBNC-32M-175WS32	TBNC32M175WS32	32.0	56.0	175.0	32.0	27.2	TBNR/RR-32M	STBN-8	K6
32mm	TBNC-32M-210WS32	TBNC32M210WS32	32.0	80.0	210.0	32.0	27.2	TBNR/RR-32M	STBN-8	K6



FLAT BOTTOM STYLE TBFI

Neutral Rake Finishing Insert

Cutter: TBDS & TBDC

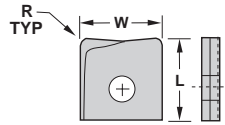

Size	Insert Description	EDP Code	W	R	L	CZ6S	Uncoated	TIN Coated	AlTiN Coated	PCD Coated	CBN Tipped*
8mm	TBFI-8M-02	TBDI8M02	8.0	(02) 0.81	12.7		●				●
8mm	TBFI-8M-04	TBFI8M04	8.0	(04) 1.60	12.7		●				●
16mm	TBFI-16M-02	TBFI16M02	16.0	(02) 0.81	14.7		●		●		
16mm	TBFI-16M-04	TBFI16M04	16.0	(04) 1.60	14.7		●		●		
20mm	TBFI-20M-02	TBFI20M02	20.0	(02) 0.81	16.3		●		●		●
20mm	TBFI-20M-04	TBFI20M04	20.0	(04) 1.60	16.3		●		●		●
25mm	TBFI-25M-02	TBFI25M02	25.0	(02) 0.81	22.0		●		●		●
25mm	TBFI-25M-04	TBFI25M04	25.0	(04) 1.60	22.0		●		●		●
25mm	TBFI-25M-08	TBFI25M08	25.0	(08) 3.18	22.0		●		●		●

BALLNOSE

BACK DRAFT STYLE TBDI - Neutral Rake Finishing Insert

Cutter: TBDS & TBDC

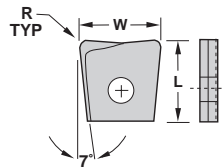

Size	Insert Description	EDP Code	W	R	L	CZ6S	GP26	ZS26S	ZS26	AC3	DX200	CB200
8mm	TBDI-8M-02	TBDI8M02	8.0	(02) 0.81	12.7		●			●		●
8mm	TBDI-8M-04	TBFI8M04	8.0	(04) 1.60	12.7		●			●		●
16mm	TBDI-16M-02	TBFI16M02	16.0	(02) 0.81	14.7		●		●	●		
16mm	TBDI-16M-04	TBFI16M04	16.0	(04) 1.60	14.7		●		●	●		
20mm	TBDI-20M-02	TBFI20M02	20.0	(02) 0.81	16.3		●		●	●		●
20mm	TBDI-20M-04	TBFI20M04	20.0	(04) 1.60	16.3		●		●	●		●
25mm	TBDI-25M-02	TBFI25M02	25.0	(02) 0.81	22.0		●		●	●		●
25mm	TBDI-25M-04	TBFI25M04	25.0	(04) 1.60	22.0		●		●	●		●
25mm	TBDI-25M-08	TBFI25M08	25.0	(08) 3.18	22.0		●		●	●		●

In an effort to improve our stock standard grade offering, there are periodic changes. Please see current price list for up to date grade offering.

- High performance choice in optimal conditions.
- ▲ Recommended grade under general conditions.

Cast Iron				●		
Non-Ferrous	▲					
Stainless/High Temp				●		
Steel				●		
Hardened Material				▲		●
Composite				▲	●	

FLAT BOTTOM/BACK DRAFT STYLE TBDS-WS

Straight Neck Holder

Use TBFI & TBFI Inserts Only

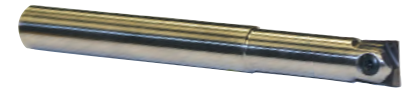
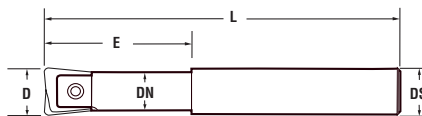

Size	Description	EDP Code	D	E	L	DS	DN	Insert	Screw	Wrench
8mm	TBDS-8M-59WS8	TBDS8M59WS8	8.0	48.0	151.9	8.0	10.5	TBFI / FI-8M	STBN-4	K3 / T-10
16mm	TBDS-16M-63WS16	TBDS16M63WS16	16.0	54.9	162.1	16.0	13.9	TBFI / FI-16M	STBN-5	K3 / T-10
20mm	TBDS-20M-68WS20	TBDS20M68WS20	20.0	62.9	175.0	20.0	18.0	TBFI / FI-20M	STBN-6	K4 / T-20
25mm	TBDS-25M-74WS25	TBDS25M74WS25	25.0	71.8	189.9	25.0	17.3	TBFI / FI-25M	STBN-7	K5 / T-25

FLAT BOTTOM/BACK DRAFT STYLE TBDC-WS

Carbide Cored Shank

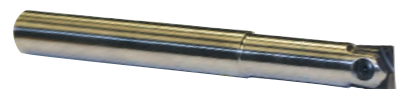
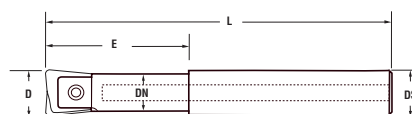

Use TBFI & TBFI Inserts Only

Size	Description	EDP Code	D	E	L	DS	DN	Insert	Screw	Wrench
8mm	TBDS-8M-59WS8	TBDS8M59WS8	8.0	48.0	151.9	8.0	10.5	TBFI / FI-8M	STBN-4	K3 / T-10
16mm	TBDS-16M-63WS16	TBDS16M63WS16	16.0	54.9	162.1	16.0	13.9	TBFI / FI-16M	STBN-5	K3 / T-10
20mm	TBDS-20M-68WS20	TBDS20M68WS20	20.0	62.9	175.0	20.0	18.0	TBFI / FI-20M	STBN-6	K4 / T-20
25mm	TBDS-25M-74WS25	TBDS25M74WS25	25.0	71.8	189.9	25.0	17.3	TBFI / FI-25M	STBN-7	K5 / T-25



Trouble Shooting

Problem	Solution	Problem	Solution	Problem	Solution	Problem	Solution	Problem	Solution
Insert is wearing prematurely	Decrease speed Increase feed Increase DOC	Insert is chipping	Use ZS26 grade Increase speed Decrease feed Decrease DOC Use Tapered Shank Use Neutral insert	Insert has built up edge	Increase speed Increase feed	Insert is wearing at center	Increase feed by 10% Decrease speed	Toolholder failure	Reduce feed Decrease tool extension Reduce DOC

RIGID-LOCK

Grade Description

Grades	Descriptions
C26S	Uncoated, tough, fine grain substrate with sharp edge. Ideal for plastics and soft materials that produce little or no heat.
ZS26	PVD AlTiN grade with a tough, fine grain substrate. FIRST CHOICE for general applications in steels, stainless, and high temp alloys. Excellent in low to high speeds and will handle interruptions and high feed rates. Coating provides highest resistance to oxidation, physical abrasion and chip welding. Dry machining capable.
ZS26S	Same as grade AT26 except with a sharper edge for light depths of cut in finishing operations. FIRST CHOICE for non-ferrous and composite materials at medium to high SFM.
CB400	PCBN tip brazed onto a carbide insert. To be used for roughing to finishing in hardened steels greater than 45 HRC such as bearing steel, hot and cold work tool steels, high-speed steels, die steels, case hardened steels, nitrided irons and some hard coatings.
DX200	CVD PCD coated grade. Excellent wear resistance in nonmetallic materials such as graphite, epoxy based resins and plastics. FIRST CHOICE in aluminum and composites at high SFM.

Chart 1

Feed, Speed and Diameter Information

Materials	Cast Iron		Steels				Stainless Steels		Nickel Based Alloys	Titanium	Aluminum
	Grey	Nodular	Low Carbon up to 240 BHN	High Carbon Medium Tensile 240-300 BHN	High Alloy Tool Steel 300-400	Hard Steels 48-65 HRC	300 Series	400 Series	Inconel Waspalloy Hastalloy	6AL 4V	6061 T6 7075 T6
Insert Grades	ZS26	ZS26	ZS26	ZS26	ZS26	ZS26	ZS26	ZS26	ZS26	ZS26	ZS26S/C26S
Speed (SMPM)	12,700-25,400	10,160-20,320	12,700-25,400	10,160-20,320	7,620-15,240	3,175-7,620	3,175-17,780	10,160-20,320	2,540-5,080	5,080-7,620	38,100-127,000
Feed Rate (MMPR)	0.152/0.508	0.152/0.508	0.152/0.406	0.152/0.406	0.152/0.406	0.076/0.228	0.152/0.305	0.152/0.356	0.102/0.254	0.102/0.279	0.381/0.889

Effective Cutting Diameter Information

The charts listed below are applicable when the depth of cut is less than the radius of the tool. The IPR can be increased as the DOC is reduced.

DOC	INSERT DIAMETER (mm)							
	6	8	9	12	16	20	25	32
0.508	3.454	3.886	4.293	4.978	5.588	6.147	7.112	7.975
1.270	5.080	5.817	6.477	7.620	8.610	9.499	11.074	12.446
1.905	5.817	6.782	7.620	9.068	10.312	11.430	13.386	15.087
2.540	6.223	7.417	8.433	10.160	11.633	12.954	15.240	17.221
3.175	6.350	7.772	8.992	10.998	12.700	14.199	16.789	19.050
3.962		7.925	9.398	11.760	13.741	15.469	18.440	20.980
4.775			9.525	12.294	14.554	16.510	19.837	22.682
6.350				12.700	15.545	17.958	21.996	25.400
7.925					15.875	18.771	23.546	27.482
9.525						19.050	24.587	29.108
12.700							25.400	31.115
15.875								31.750

Effective diameters for standard inserts at various DOC's (mm)

$$RPM = SFM \times 3.82 / \text{Effective cutting diameter}$$

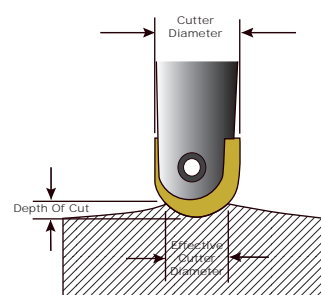

DOC	INSERT DIAMETER (mm)							
	6	8	9	12	16	20	25	32
0.508	85.242	100.406	110.058	127.000	141.986	155.549	179.603	200.812
1.270	56.794	63.500	69.570	80.315	89.814	98.374	113.589	127.000
1.905	46.380	51.841	56.794	65.583	73.329	80.315	92.735	103.683
2.540	40.157	44.907	49.174	56.794	63.500	69.571	80.315	89.814
3.175	35.916	40.157	43.992	50.800	56.794	62.205	71.831	80.315
3.962		35.941	39.370	45.466	50.850	55.702	64.313	71.907
4.775			35.916	41.478	46.380	50.800	58.649	65.583
6.350				35.916	40.157	43.993	50.800	56.794
7.925					35.941	39.370	45.466	50.850
9.525						35.916	41.478	46.380
12.700							35.916	40.157
15.875								35.916

Example

Effective Diameter		
ACTUAL DIAMETER	DOC	EFFECTIVE DIAMETER
20	2.54	12.70

Example

Adjusted Feed Rate for Above		
CHART 1 IPR	CHART 3 MULTIPLIER	ADJUSTED IPR
0.203	69.57	0.559



Shallow Cutting with Rigid-Lock Ball Nose End Mill

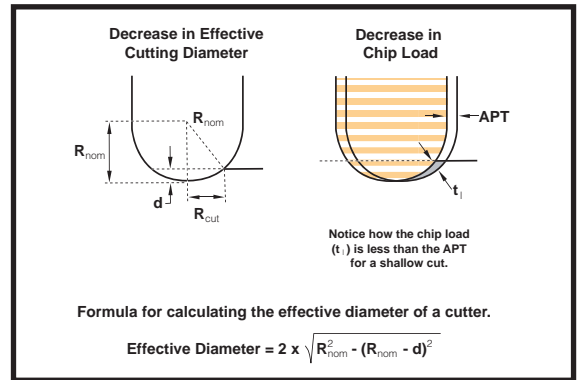

Using your Rigid-Lock Ball Nose End Mill

- Use Anti-seize grease every time an insert is changed.
- Use positive geometry inserts on stainless, aluminum, titanium and Inconel.
- Climb mill whenever possible.
- Step over should be greater than depth of cut
- Use TBFI inserts if work piece has a draft angle on the walls. TBDI inserts are for work pieces with straight walls.
- Balance chipload, RPM, feed rate, tool extension, and material.
- TBFI and TBDI inserts cannot plunge, ramp at 1° to 2° angle maximum.
- 6mm and 8mm endmills have a maximum feed rate of .152 to .203 mm per revolution and a .381 to .457 mm depth of cut.

Recommended torque specifications for Rigid-Lock insert screws

insert screw	insert size	wrench	TORQUE	
			Nm/inch lbs.	anti-seize
STBN-1	6mm	K2/T-8	Manual	Yes
STBN-2	8mm	K3/T-10	Manual	Yes
STBN-3	10mm	K3/T-10	Manual	Yes
STBN-4	12mm	K35/T-15	6.0/53	Yes
STBN-5	16mm	K35/T-15	6.2/55	Yes
STBN-6/TS352	20mm	K4/T-20	6.2/55	Yes
STBN-7/TS41	25mm	K5/T-25	6.5/58	Yes
STBN-8/TS50	32mm	K6/T-30	6.5/58	Yes
STBN-8	38mm	K6/T-30	6.5/58	Yes
STBN-8	55mm	3/16 HEX	6.5/58	Yes
STBN-10	63mm	1/4 HEX	6.5/58	Yes

Using your Rigid-Lock Ball Nose End Mill for Roughing - TBXR

Adjust to your own cutting conditions.

Ex: Cutting 4140 material, 19.1 diameter ball nose insert, .254 chip load and 9.53 D.O.C.
Chip load per tooth: Should be a maximum of .178-.254.

Maximum Depth of Cut: Equal to half the radius of the insert.

Ex. If you are using a 25mm diameter insert, then the D.O.C. would be up too 12.7mm.

For optimal tool life of our ballnose system, we recommend lighter feed rates and higher surface speeds.

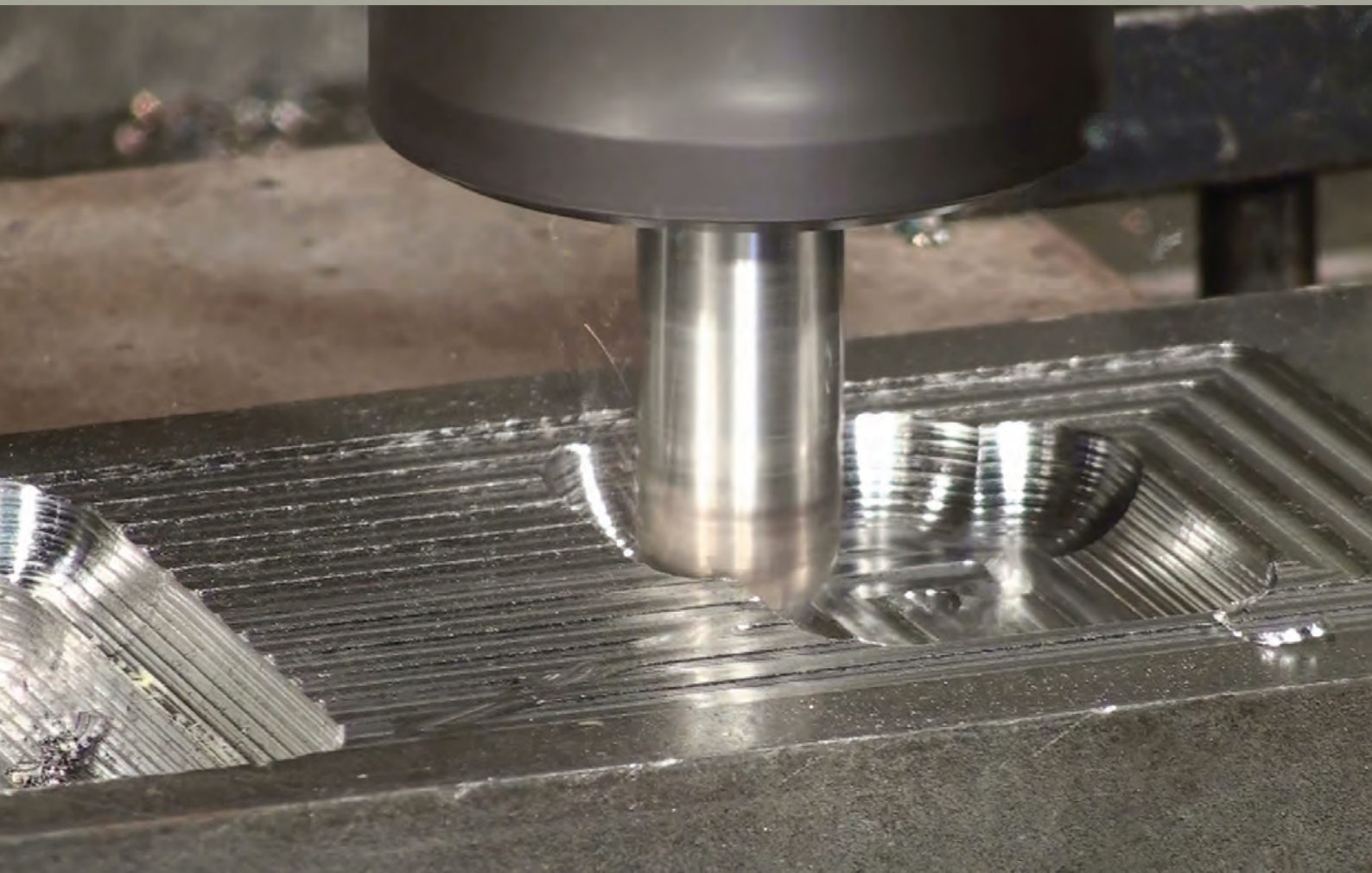
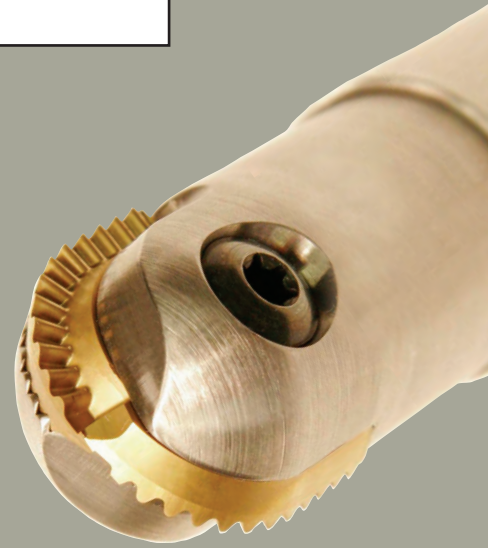
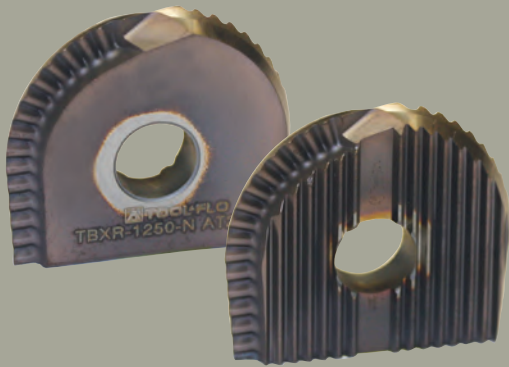

TOOL FLO
Member IMC Group



BANTAM

Small diameter
Threading • Boring • Grooving



Bantam Boring Bar Nomenclature Chart

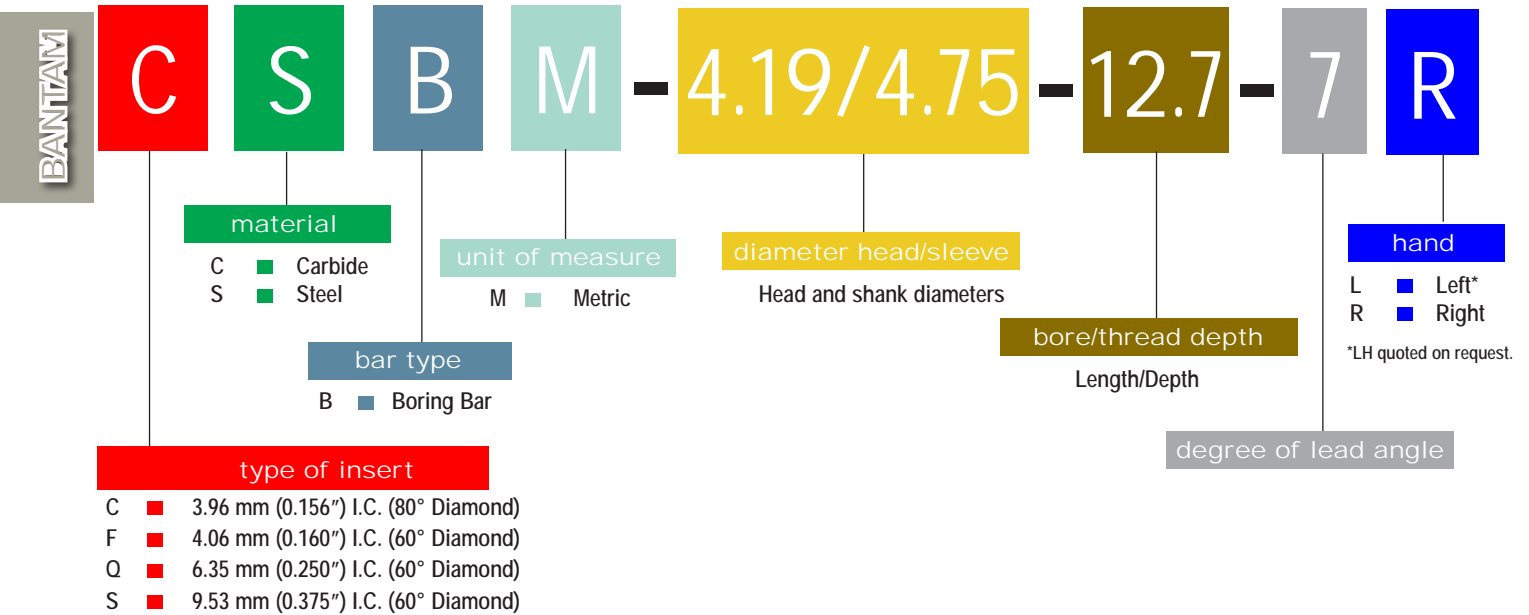

Bantam Grooving/Threading Bar Nomenclature Chart

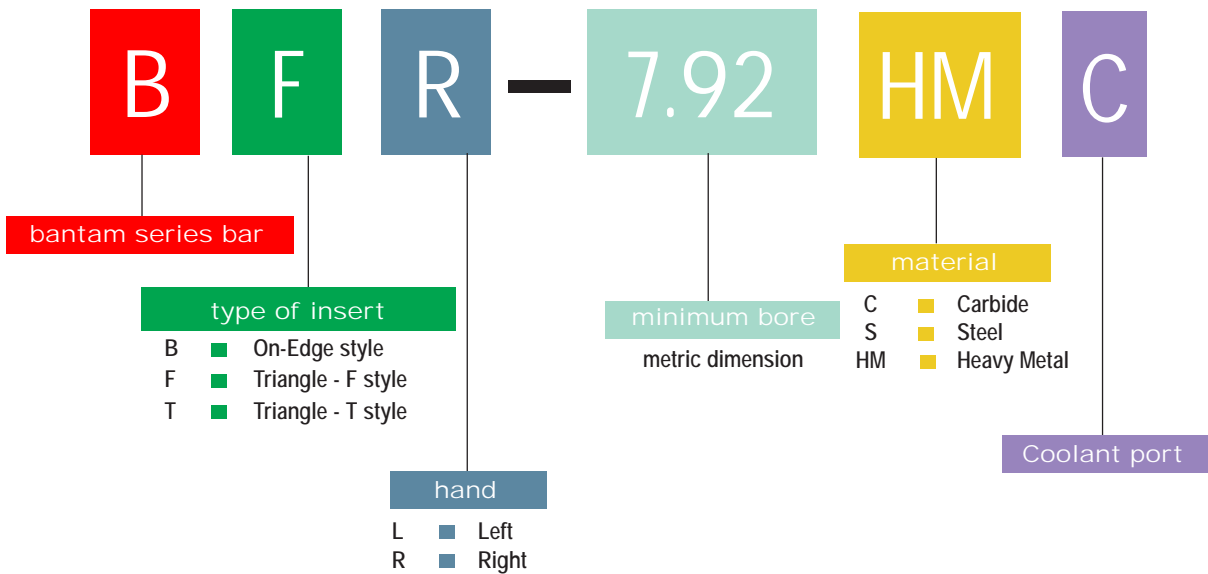

SAVE!!!

Ask about our refurbished heavy metal bars at a discount price!



MINIMUM BORE 4.57

BORING
CDCD

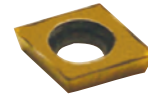
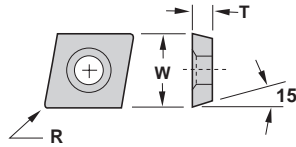

Description	EDP Code	T	W	R	Coating				
					C22	GP22	GP4	AC22	AC4
CDCD-500	9BCD500	1.02	3.96	0.05	●	●	●		
CDCD-505	9BCD505	1.02	3.96	0.18	●	●	●		
CDCD-51	9BCD51	1.02	3.96	0.38	●	●	●		

BORING - Positive Rake CDCG

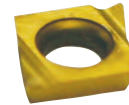
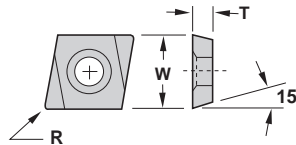

Description	EDP Code	T	W	R	Coating				
					C22	GP22	GP4	AC22	AC4
CDCG-500L	9BCG500L	1.02	3.96	0.05		●	●		
CDCG-505L	9BCG505L	1.02	3.96	0.18		●	●		
CDCG-51L	9BCG51L	1.02	3.96	0.38	●	●	●		

In an effort to improve our stock standard grade offering, there are periodic changes. Please see current price list for up-to-date grade offering.

- High performance choice in optimal conditions.
- ▲ Recommended grade under general conditions.

Material	C22	GP22	GP4	AC22	AC4
Cast Iron		●	▲		
Non-Ferrous	●	▲			
Stainless/High Temp	●	▲			
Steel	●	▲			

CCBM/CSBM

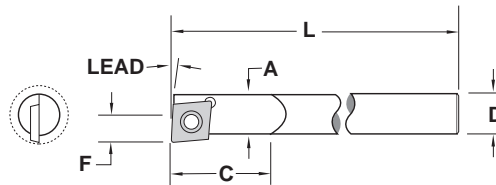

Description	EDP Code	Material	Insert	Lead	A	D	L	C	F	Min Bore	Screw*
CSBM-42/5-60-7R	9BCSM4257R	Steel	CDCD/G	7°	4.19	5.00	60.00	12.70	2.39	4.57	TS1
CCBM-42/4-150-7R	9BCCM4247R	Carbide	CDCD/G	7°	4.19	4.00	150.00	---	2.39	4.57	TS1
CSBM-45/5-60-5R	9BCSM4555R	Steel	CDCD/G	5°	4.57	5.00	60.00	12.70	2.64	5.28	TS1
CCBM-48/5-100-5R	9BCCM4555R	Carbide	CDCD/G	5°	4.80	5.00	100.00	---	2.64	5.28	TS1
CSBM-6-80-5R	9BCSM6805R	Steel	CDCD/G	5°	6.60	6.00	80.00	---	3.68	7.24	TS1
CCBM-6-100-5R	9BCCM61005R	Carbide	CDCD/G	5°	6.55	6.00	100.00	---	3.68	7.24	TS1
CSBM-6-80-0R	9BCSM6800R	Steel	CDCD/G	0°	6.60	6.00	80.00	---	3.86	7.42	TS1
CCBM-6-100-0R	9BCCM61000R	Carbide	CDCD/G	0°	6.55	6.00	100.00	---	3.86	7.42	TS1

*TS1 screw uses K05 wrench

CCBM/CSBM

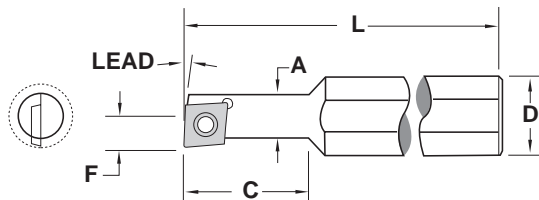

Description	EDP Code	Material	Insert	Lead	A	D	L	C	F	Min Bore	Screw*
CSBM-45/12-12-5R	9BCSM4512125R	Steel	CDCD/G	5°	4.57	12.00	70.00	12.70	2.64	5.28	TS1
CCBM-48/12-22-5R	9BCCM4812225R	Carbide	CDCD/G	5°	4.80	12.00	60.00	22.23	2.64	5.28	TS1
CSBM-66/12-19-5R	9BCSM6612195R	Steel	CDCD/G	5°	6.60	12.00	70.00	19.05	3.68	7.24	TS1
CCBM-65/12-32-5R	9BCCM6512325R	Carbide	CDCD/G	5°	6.55	12.00	70.00	31.75	3.68	7.24	TS1
CSBM-66/12-19-0R	9BCSM6612190R	Steel	CDCD/G	0°	6.60	12.00	70.00	19.05	3.86	7.42	TS1
CCBM-65/12-32-0R	9BCCM6512320R	Carbide	CDCD/G	0°	6.55	12.00	70.00	31.75	3.86	7.42	TS1

*TS1 screw uses K05 wrench



MINIMUM BORE 6.35

BORING
BSBR

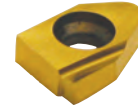
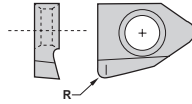

	Uncoated	TIN Coated	AlTiN Coated
C22	GP22	GP4	AC22
		●	AC4

Description	EDP Code		0.13
BSBR-005	9BSBR		

BSR

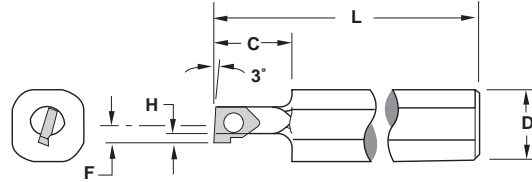

Description	EDP Code	Material	Insert	Port	L	D	C	H	F**	Min. Bore	Screw*
BSRM-6.35S	9B250S	Steel	BSBR		127.00	12.00	12.70	1.27	3.18	6.35	TS1
BSRM-6.35SC	9B250SC	Steel	BSBR	✓	127.00	12.00	12.70	1.27	3.18	6.35	TS1

*TS1 screw uses K05 wrench
** Dimension over sharp point

MINIMUM BORE 6.98 - 9.14

BORING
TDAB

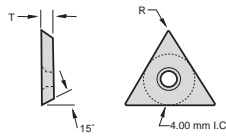

	Uncoated	TIN Coated	AlTiN Coated
C22	GP22	GP4	AC22
	●	●	AC4

Description	EDP Code	R	T
TDAB-505	9BDB505	0.18	1.19
TDAB-51	9BDB51	0.38	1.19

BORING - Positive Rake
TDCG

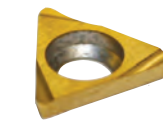
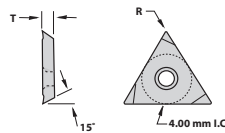

	Uncoated	TIN Coated	AlTiN Coated
C22	GP22	GP4	AC22
	●	●	AC4
	●	●	

Description	EDP Code	R	T
TDCG-505L	9BDG505L	0.18	1.19
TDCG-51L	9BDG51L	0.38	1.19

In an effort to improve our stock standard grade offering, there are periodic changes. Please see current price list for up-to-date grade offering.

- High performance choice in optimal conditions.
- ▲ Recommended grade under general conditions.

Cast Iron	●	▲		
Non-Ferrous	●	▲		
Stainless/High Temp	●	▲		
Steel	●	▲		

FCBI/FSBI

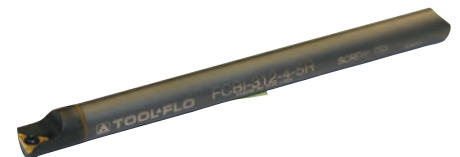
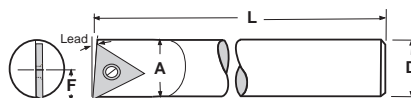

Description	EDP Code	Material	Insert	Lead	A	D	L	F	Min. Bore	Screw*
FCBM-52-100-5R	9BFCM521005R	Carbide	TDAB/TDCG	5°	5.16	5.00	100.00	3.20	6.99	TS3
FCBM-63-100-5R	9BFCM631005R	Carbide	TDAB/TDCG	5°	6.35	6.00	100.00	3.96	7.62	TS3
FSBM-64-100-5R	9BFSM641005R	Steel	TDAB/TDCG	5°	6.60	6.00	100.00	3.96	7.62	TS3
FCBM-79-100-5R	9BFCM791005R	Carbide	TDAB/TDCG	5°	7.92	8.00	100.00	4.75	9.14	TS3

*TS3 screw uses K1 wrench



MINIMUM BORE 7.925 BORING BFR3

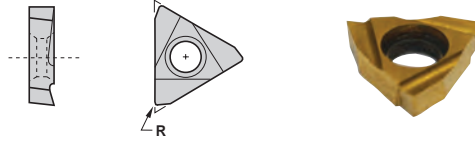

Uncoated		TIN Coated		AlTiN Coated	
C22	GP22	GP4	AC22	AC4	
	●	●			

Description	EDP Code	R
BFR3-BR	9BFR3B	0.13

BFR3

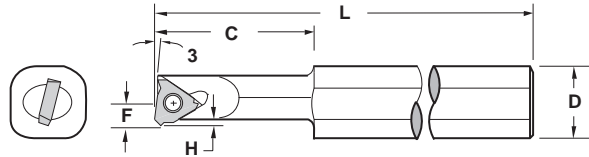

Description	EDP Code	Material	Insert	Coolant Port	L	D	C	H	F	Min. Bore	Screw*
BFRM-7.9S	9BFM79S	Steel	BFR3		127.00	12	12.70	1.27	3.81	7.92	TS25
BFRM-7.9SC	9BFM79SC	Steel	BFR3	✓	127.00	12	12.70	1.27	3.81	7.92	TS25
BFRM-7.9HM	9BFM79HM	Heavy Metal	BFR3		127.00	12	31.75	1.27	3.81	7.92	TS25
BFRM-7.9HMC	9BFM79HMC	Heavy Metal	BFR3	✓	127.00	12	31.75	1.27	3.81	7.92	TS25

*TS25 screw uses K2 wrench

MINIMUM BORE 7.925 - 11.18 BORING BNBR/L

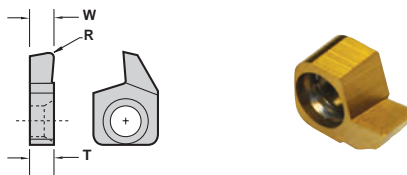

Uncoated		TIN Coated		AlTiN Coated	
C22	GP22	GP4	AC22	AC4	
	●	●			

Description	EDP Code	W	R	T
BNBR-125W	9BB125R	3.18	0.13/0.25	3.48
BNBL-125W	9BB125L	3.18	0.13/0.25	3.48

Back Turning BNPR/L

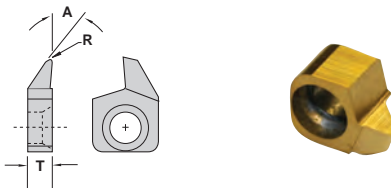

Uncoated		TIN Coated		AlTiN Coated	
C22	GP22	GP4	AC22	AC4	
	●	●			

Description	EDP Code	A	R	T
BNPR-015R	9BP015R	45°	0.38	3.48
BNPL-015R	9BP015L	45°	0.38	3.48

In an effort to improve our stock standard grade offering, there are periodic changes. Please see current price list for up-to-date grade offering.

- High performance choice in optimal conditions.
- ▲ Recommended grade under general conditions.

Cast Iron		●	▲		
Non-Ferrous	●	▲			
Stainless/High Temp	●	▲			
Steel	●	▲			

BB

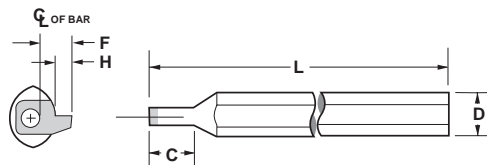

Description	EDP Code	Material	Insert	L	D	C	F	H	Min. Bore	Screw*
BBM-7.9S	9BM79S	Steel	BNBR/L BNPR/L	127.00	7.9	20.00	3.96	1.78	7.92	TS25
BBM-8.7S	9BM87S	Steel	BNBR/L BNPR/L	127.00	8.7	20.00	3.86	1.78	8.74	TS25
BBM-9.5S	9BM95S	Steel	BNBR/L BNPR/L	127.00	9.5	20.00	4.13	1.78	9.53	TS25
BBM-11S	9BM11S	Steel	BNBR/L BNPR/L	127.00	11	25.00	4.83	1.78	11.18	TS25
BBM-7.9HM	9BM79HM	Heavy Metal	BNBR/L BNPR/L	127.00	7.9	25.00	3.96	1.78	7.92	TS25
BBM-8.7HM	9BM87HM	Heavy Metal	BNBR/L BNPR/L	127.00	8.7	25.00	3.86	1.78	8.74	TS25
BBM-9.5HM	9BM95HM	Heavy Metal	BNBR/L BNPR/L	127.00	9.5	32.00	4.13	1.78	9.53	TS25
BBM-11HM	9BM11HM	Heavy Metal	BNBR/L BNPR/L	127.00	11	40.00	4.83	1.78	11.18	TS25
BBM-7.9C	9BM79C	Carbide	BNBR/L BNPR/L	127.00	7.9	32.00	3.96	1.78	7.92	TS25
BBM-11C	9BM11C	Carbide	BNBR/L BNPR/L	127.00	11	40.00	4.83	1.78	11.18	TS25

*TS25 screw uses K2 wrench



MINIMUM BORE 10.160

BORING
BFR4

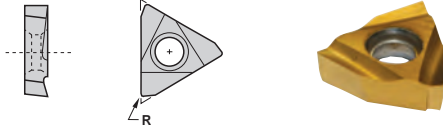

Description	EDP Code	R	Uncoated		TIN Coated		AlTiN Coated	
			C22	GP22	GP4	AC22	AC4	
BFR4-BR	9BFR4B	0.13	●	●				

BFR4

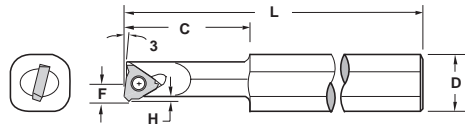

Description	EDP Code	Material	Insert	Coolant Port	L	D	C	H	F	Min. Bore	Screw*
BFRM-10.1S	9BF101S	Steel	BFR4		127.00	12	25.40	1.27	6.02	10.16	TS25
BFRM-10.1SC	9BF101SC	Steel	BFR4	✓	127.00	12	25.40	1.27	6.02	10.16	TS25
BFRM-10.1HM	9BF101HM	Heavy Metal	BFR4		127.00	12	25.40	1.27	6.02	10.16	TS25
BFRM-10.1HMC	9BF101HMC	Heavy Metal	BFR4	✓	127.00	12	25.40	1.27	6.02	10.16	TS25

*TS25 screw uses K2 wrench
** Dimension over sharp point

MINIMUM BORE 11.125

BORING
TPCB

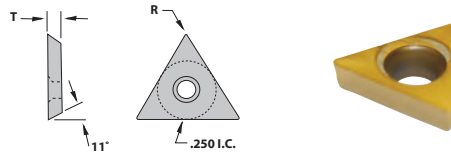

Description	EDP Code	R	T	Uncoated		TIN Coated		AlTiN Coated	
				C22	GP22	GP4	AC22	AC4	
TPCB-2205	9BPB2205	0.18	2.44	●	●				
TPCB-221	9BPB221	0.38	2.44	●	●				

BORING - Positive Rake
TPCG

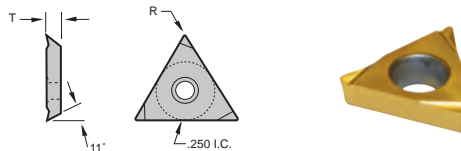

Description	EDP Code	R	T	Uncoated		TIN Coated		AlTiN Coated	
				C22	GP22	GP4	AC22	AC4	
TPCG-2205L	9BPG2205	0.18	2.44	●	●				
TPCG-221L	9BPG221L	0.38	2.44	●	●				

In an effort to improve our stock standard grade offering, there are periodic changes. Please see current price list for up-to-date grade offering.

● High performance choice in optimal conditions.
▲ Recommended grade under general conditions.

Cast Iron	●	▲							
Non-Ferrous	●	▲							
Stainless/High Temp	●	▲							
Steel	●	▲							

QCBM/QSBM

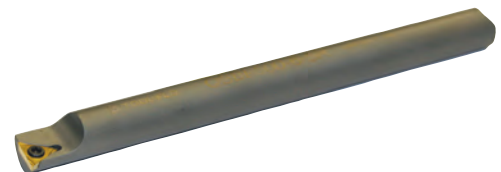
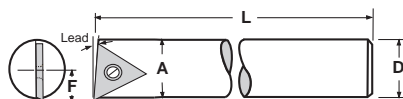

Description	EDP Code	Material	Insert	Lead	A	D	L	F	Min. Bore	Screw*
QSBM-10-10-5R	9BQS375R	Steel	TPCB/G	5°	9.78	10	127.00	5.61	11.13	TSM6
QCBM-10-10-5R	9BQC375R	Carbide	TPCB/G	5°	9.91	10	152.00	5.36	11.13	TSM6
QCBM-13-12-5R	9BQC505R	Carbide	TPCB/G	5°	12.95	12	203.00	7.52	14.30	TSM6

*TS6 screw uses K3 wrench



MINIMUM BORE 12.70 BORING BTBR/L

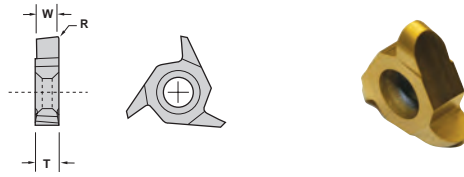

Description	EDP Code	W	R	T	Uncoated		TIN Coated		A/TIN Coated	
					C22	GP22	GP4	AC22	AC4	
BTBR-125	9BTB125R	3.18	0.13/0.25	3.30		●	●			
BTBL-125	9BTB125L	3.18	0.13/0.25	3.30		●	●			

BTR/L

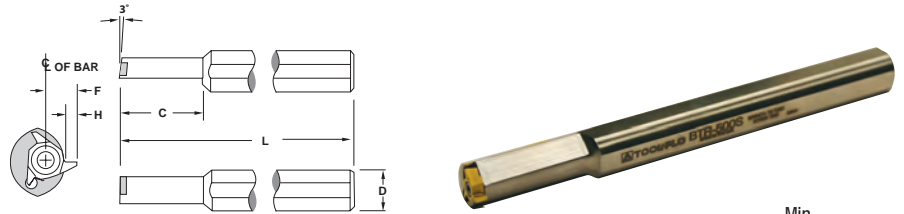

Description	EDP Code	Material	Insert	L	D	C	H	F	Min. Bore	Screw*
BTLM-12.7S	9BTLM127S	Steel	BTBL	127.00	12	31.75	1.91	5.72	12.70	TS25
BTRM-12.7HM	9BTRM127HM	Heavy Metal	BTBR	127.00	12	38.10	1.91	5.72	12.70	TS25
BTLM-12.7HM	9BTLM127HM	Heavy Metal	BTBL	127.00	12	38.10	1.91	5.72	12.70	TS25

*TS25 screw uses K2 wrench
** Dimension over sharp point

MINIMUM BORE 6.35 GROOVING BSGR

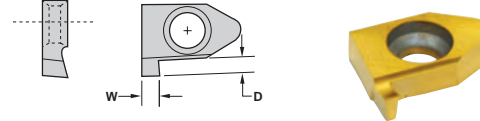

Description	EDP Code	W	D	Uncoated		TIN Coated		A/TIN Coated	
				C22	GP22	GP4	AC22	AC4	
BSGR-015W	9BSG015R	0.38 (.015")	0.76			●			
BSGR-020W	9BSG020R	0.51 (.020")	1.27			●			
BSGR-031W	9BSG031R	0.79 (.031")	1.27			●			
BSGR-047W	9BSG047R	1.19 (.047")	1.27			●			

In an effort to improve our stock standard grade offering, there are periodic changes. Please see current price list for up-to-date grade offering.

- High performance choice in optimal conditions.
- ▲ Recommended grade under general conditions.

Cast Iron	●	▲			
Non-Ferrous	●	▲			
Stainless/High Temp	●	▲			
Steel	●	▲			

BSR

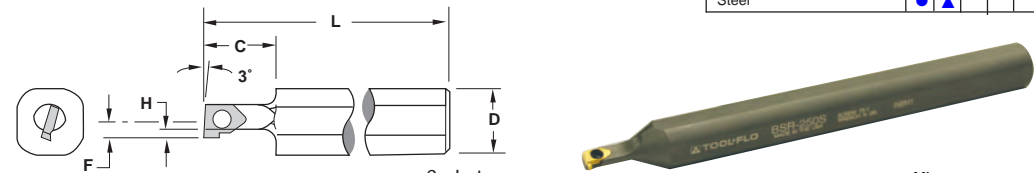

Description	EDP Code	Material	Insert	Coolant Port	L	D	C	H	F**	Min. Bore	Screw
BSRM-6.35SC	9BM635SC	Steel	BSGR	✓	127.00	12	12.70	1.27	3.99	6.35	TS1

MINIMUM BORE 7.92 GROOVING BFR3

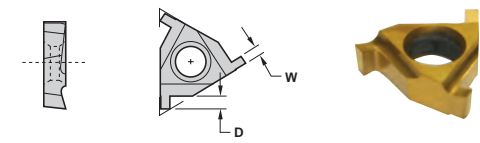

Description	EDP Code	W	D	Uncoated		TIN Coated		A/TIN Coated	
				C22	GP22	GP4	AC22	AC4	
BFR3-015W	9BFR3G015	0.38 (.015")	0.51			●			
BFR3-020W	9BFR3G020	0.51 (.020")	0.76			●			
BFR3-031W	9BFR3G031	0.79 (.031")	0.89			●			

BFR3

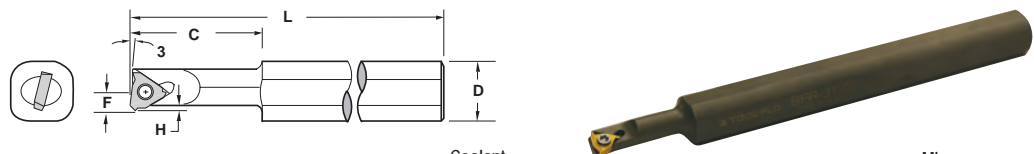

Description	EDP Code	Material	Insert	Coolant Port	L	D	C	H	F	Min. Bore	Screw*
BFRM-7.92SC	9BFM792SC	Steel	BFR3	✓	127.00	12	25.40	1.27	3.81	7.92	TS25
BFRM-7.92HM	9BFM792HM	Heavy Metal	BFR3		127.00	12	25.40	1.27	3.81	7.92	TS25
BFRM-7.92HMC	9BFM792HMC	Heavy Metal	BFR3	✓	127.00	12	25.40	1.27	3.81	7.92	TS25

*TS25 screw uses K2 wrench



MINIMUM BORE 7.92 - 11.18

GROOVING BNGR/L

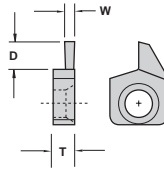

RH Shown

Description	EDP Code	W	D	T	Uncoated		TIN Coated		AlTiN Coated	
					C22	GP22	GP4	AC22	AC4	
BNGR-031W	9BG031R	0.79 (.031")	1.27	3.48	●	●	●	●		
BNGL-031W	9BG031L	0.79 (.031")	1.27	3.48	●	●	●	●		
BNGR-047W	9BG047R	1.19 (.047")	1.78	3.48	●	●	●	●		
BNGL-047W	9BG047L	1.19 (.047")	1.78	3.48	●	●	●	●		
BNGR-062W	9BG062R	1.57 (.062")	1.78	3.48	●	●	●	●		
BNGL-062W	9BG062L	1.57 (.062")	1.78	3.48	●	●	●	●		
BNGR-094W	9BG094R	2.39 (.094")	1.78	3.48	●	●	●	●		
BNGL-094W	9BG094L	2.39 (.094")	1.78	3.48	●	●	●	●		
BNGR-125W	9BG125R	3.18 (.125")	1.78	3.48	●	●	●	●		
BNGL-125W	9BG125L	3.18 (.125")	1.78	3.48	●	●	●	●		

GROOVING - Full Nose Radius BNRR/L

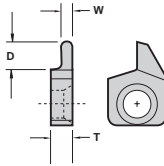

RH Shown

Description	EDP Code	W	R	D	T	Uncoated		TIN Coated		AlTiN Coated	
						C22	GP22	GP4	AC22	AC4	
BNRR-031W	9BR031R	0.79 (.031")	0.39	1.27	●	●	●	●			
BNRL-031W	9BR031L	0.79 (.031")	0.39	1.27	●	●	●	●			
BNRR-047W	9BR047R	1.19 (.047")	0.60	1.78	●	●	●	●			
BNRL-047W	9BR047L	1.19 (.047")	0.60	1.78	●	●	●	●			
BNRR-062W	9BR062R	1.57 (.062")	0.79	1.78	●	●	●	●			
BNRL-062W	9BR062L	1.57 (.062")	0.79	1.78	●	●	●	●			
BNRR-094W	9BR094R	2.39 (.094")	1.19	1.78	●	●	●	●			
BNRL-094W	9BR094L	2.39 (.094")	1.19	1.78	●	●	●	●			
BNRR-125W	9BR125R	3.18 (.125")	1.59	1.78	●	●	●	●			
BNRL-125W	9BR125L	3.18 (.125")	1.59	1.78	●	●	●	●			

In an effort to improve our stock standard grade offering, there are periodic changes. Please see current price list for up-to-date grade offering.

- High performance choice in optimal conditions.
- ▲ Recommended grade under general conditions.

Cast Iron	●	▲			
Non-Ferrous	●	▲			
Stainless/High Temp	●	▲			
Steel	●	▲			

BBM

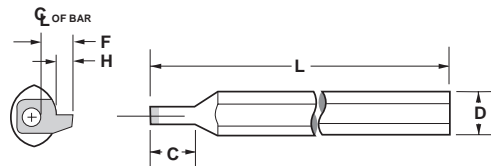

Description	EDP Code	Material	Insert	L	D	C	F	H	Min. Bore	Screw*
BBM-7.9S	9BM79S	Steel	BNGR/L BNRR/L	127.00	12.00	19.05	3.96	1.78	7.92	TS25
BBM-8.7S	9BM87S	Steel	BNGR/L BNRR/L	127.00	12.00	19.05	3.86	1.78	8.74	TS25
BBM-9.5S	9BM95S	Steel	BNGR/L BNRR/L	127.00	12.00	19.05	4.13	1.78	9.53	TS25
BBM-11.2S	9BM112S	Steel	BNGR/L BNRR/L	127.00	12.00	25.40	4.83	1.78	11.18	TS25
BBM-7.9HM	9BM79HM	Heavy Metal	BNGR/L BNRR/L	127.00	12.00	25.40	3.96	1.78	7.92	TS25
BBM-8.7HM	9BM87HM	Heavy Metal	BNGR/L BNRR/L	127.00	12.00	25.40	3.86	1.78	8.74	TS25
BBM-9.5HM	9BM95HM	Heavy Metal	BNGR/L BNRR/L	127.00	12.00	31.75	4.13	1.78	9.53	TS25
BBM-11.2HM	9BM112HM	Heavy Metal	BNGR/L BNRR/L	127.00	12.00	38.10	4.83	1.78	11.18	TS25
BBM-7.9C	9BM79C	Carbide	BNGR/L BNRR/L	127.00	12.00	31.75	3.96	1.78	7.92	TS25
BBM-11.2C	9BM112C	Carbide	BNGR/L BNRR/L	127.00	12.00	38.10	4.83	1.78	11.18	TS25

*TS25 screw uses K2 wrench



MINIMUM BORE 10.2 GROOVING BFR4

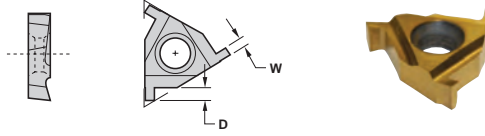

Description	EDP Code	W	D	Coating			
				C22	GP22	GP4	AC22 AC4
BFR4-015W	9BFR4G015	0.38 (.015")	0.89	Uncoated	TIN Coated		
BFR4-020W	9BFR4G020	0.51 (.020")	0.89	●	●		
BFR4-031W	9BFR4G031	0.79 (.031")	0.89	●	●		

BFRM4

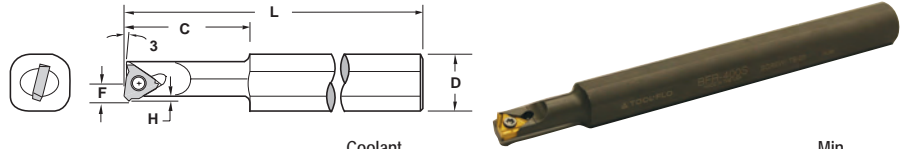

Description	EDP Code	Material	Insert	Coolant Port	L	D	C	H	F**	Min. Bore	Screw*
BFRM-10.1S	9BFM101S	Steel	BFR4		127.00	12.0	25.40	1.27	6.02	10.16	TS25
BFRM-10.1SC	9BFM101SC	Steel	BFR4	✓	127.00	12.00	25.40	1.27	6.02	10.16	TS25
BFRM-10.1HM	9BFM101HM	Heavy Metal	BFR4		127.00	12.00	25.40	1.27	6.02	10.16	TS25
BFRM-10.1HMC	9BFM101HMC	Heavy Metal	BFR4	✓	127.00	12.00	25.40	1.27	6.02	10.16	TS25

TS25 screw uses K2 wrench
** Dimension over sharp point

MINIMUM BORE 12.7 GROOVING BTGR/L



Description	EDP Code	W	D	T	Coating				
					C22	GP22	GP4	AC22 AC4	
BTGR-031W	9BTG031R	0.79 (.031")	1.27	3.30		●	●		
BTGL-031W	9BTG031L	0.79 (.031")	1.27	3.30		●	●		
BTGR-047W	9BTG047R	1.19 (.047")	1.78	3.30		●	●		
BTGL-047W	9BTG047L	1.19 (.047")	1.78	3.30		●	●		
BTGR-062W	9BTG062R	1.57 (.062")	1.91	3.30		●	●		
BTGL-062W	9BTG062L	1.57 (.062")	1.91	3.30		●	●		
BTGR-094W	9BTG094R	2.39 (.094")	1.91	3.30		●	●		
BTGL-094W	9BTG094L	2.39 (.094")	1.91	3.30		●	●		
BTGR-125W	9BTG125R	3.18 (.125")	1.91	3.30		●	●		
BTGL-125W	9BTG125L	3.18 (.125")	1.91	3.30		●	●		

GROOVING - Full Nose Radius BTRR/L

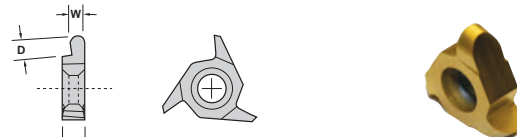

Description	EDP Code	W	R	D	T	Coating			
						C22	GP22	GP4	AC22 AC4
BTRR-031W	9BTR031R	0.79 (.031")	0.39	1.27	3.30			●	
BTRL-031W	9BTR031L	0.79 (.031")	0.39	1.27	3.30			●	
BTRR-047W	9BTR047R	1.19 (.047")	0.60	1.78	3.30			●	
BTRL-047W	9BTR047L	1.19 (.047")	0.60	1.78	3.30			●	
BTRR-062W	9BTR062R	1.57 (.062")	0.79	1.91	3.30			●	
BTRL-062W	9BTR062L	1.57 (.062")	0.79	1.91	3.30			●	
BTRR-094W	9BTR094R	2.39 (.094")	1.19	1.91	3.30			●	
BTRL-094W	9BTR094L	2.39 (.094")	1.19	1.91	3.30			●	
BTRR-125W	9BTR125R	3.18 (.125")	1.59	1.91	3.30			●	
BTRL-125W	9BTR125L	3.18 (.125")	1.59	1.91	3.30			●	

In an effort to improve our stock standard grade offering, there are periodic changes. Please see current price list for up-to-date grade offering.

- High performance choice in optimal conditions.
- ▲ Recommended grade under general conditions.

Cast Iron		●		
Non-Ferrous		●		
Stainless/High Temp		●		
Steel		●		

BTR/LM

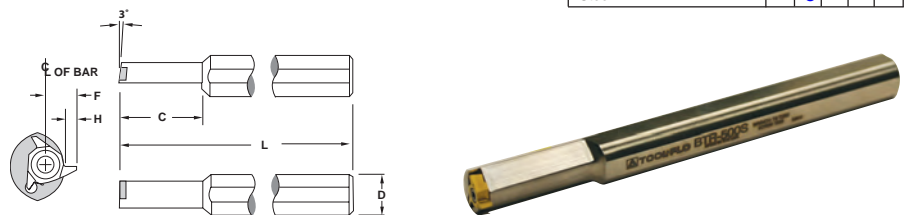

Description	EDP Code	Material	Insert	L	D	C	H	F	Min. Bore	Screw*
BTRM-12.7S	9BTR127S	Steel	BTBR/BTRR	127.00	12.00	31.75	1.91	5.72	12.70	TS25
BTLM-12.7S	9BTL127S	Steel	BTBL/BTRL	127.00	12.00	31.75	1.91	5.72	12.70	TS25
BTRM-12.7HM	9BTR127HM	Heavy Metal	BTBR/BTRR	127.00	12.00	38.10	1.91	5.72	12.70	TS25
BTLM-12.7HM	9BTL127HM	Heavy Metal	BTBL/BTRL	127.00	12.00	38.10	1.91	5.72	12.70	TS25

*TS25 screw uses K2 wrench



MINIMUM BORE 6.35

THREADING - NPT BSVR

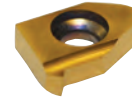
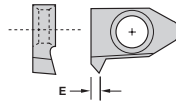

Description	EDP Code	TPI	E	Uncoated		TIN Coated		A/TIN Coated	
				C22	GP22	GP4	AC22	AC4	
BSVR-14NPT	9BSV14R	14	1.14			●			
BSVR-18NPT	9BSV18R	18	0.84			●			
BSVR-27NPT	9BSV27R	27	0.66			●			

THREADING - ISO BSVR

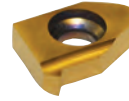
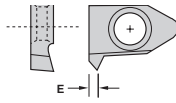

Description	EDP Code	TPI	Uncoated		TIN Coated		A/TIN Coated	
			C22	GP22	GP4	AC22	AC4	
BSVR-0.75 ISO	9BSI75R	12						
BSVR-1.0 ISO	9BSI10R	16			●			
BSVR-1.25 ISO	9BSI125R	18			●			
BSVR-1.5 ISO	9BSI15R	20			●			
BSVR-1.75 ISO	9BSI175R	24			●			
BSVR-2.0 ISO	9BSI20R	28			●			

THREADING - UN BSVR

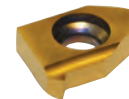
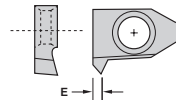

Description	EDP Code	TPI	E	Uncoated		TIN Coated		A/TIN Coated	
				C22	GP22	GP4	AC22	AC4	
BSVR-12UN	9BSU12R	12	1.02			●			
BSVR-16UN	9BSU16R	16	0.79			●			
BSVR-18UN	9BSU18R	18	0.74			●			
BSVR-20UN	9BSU20R	20	0.66			●			
BSVR-24UN	9BSU24R	24	0.58			●			
BSVR-28UN	9BSU28R	28	0.53			●			
BSVR-32UN	9BSU32R	32	0.48			●			

THREADING - 55°/60° V BSVR

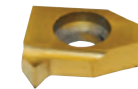
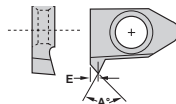

Description	EDP Code	TPI	R/F	E	A	Uncoated		TIN Coated		A/TIN Coated	
						C22	GP22	GP4	AC22	AC4	
BSVR-55	9BSV55R	0.5 - 1.6	0.08F	0.99	55°			●			
BSVR-60	9BSV60R	0.5 - 1.6	0.08R	0.99	60°			●			

In an effort to improve our stock standard grade offering, there are periodic changes. Please see current price list for up to date grade offering.

- High performance choice in optimal conditions.
- ▲ Recommended grade under general conditions.

Cast Iron		●			
Non-Ferrous		●			
Stainless/High Temp		●			
Steel		●			

BSRM

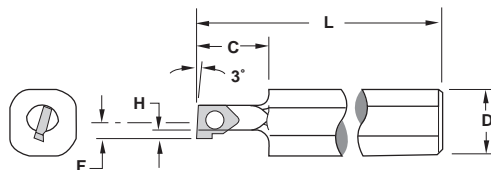

Description	EDP Code	Material	Insert	Coolant Port	L	D	C	H	F**	Min. Bore	Screw*
BSRM-6.35S	9BM635S	Steel	BSVR		127.00	12.00	12.70	1.27	3.99	6.35	TS1
BSRM-6.35SC	9BM635SC	Steel	BSVR	✓	127.00	12.00	12.70	1.27	3.99	6.35	TS1

*TS1 screw uses K05 wrench
** Dimension over sharp point



MINIMUM BORE 7.9 THREADING - 60° V BHV

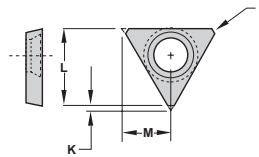

Description	EDP Code	TPI	F	C22	GP22	GP4	AC22	AC4
BHV-002	9BHV002	0.5 - 1.6	0.05		●	●		

BHRM

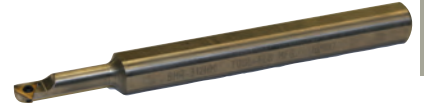
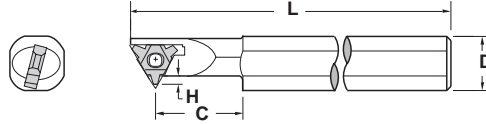

Description	EDP Code	Material	Insert	L	D	C	H	Min. Bore	Screw*
BHRM-7.9S	9BHRM79S	Steel	BHV	101.60	12.00	19.05	1.52	7.92	TS3
BHRM-7.9HM	9BHRM79HM	Heavy Metal	BHV	101.60	12.00	25.40	1.52	7.92	TS3

*TS3 screw uses K1 wrench

MINIMUM BORE 7.9 THREADING - NPT BFR3

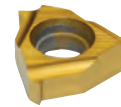
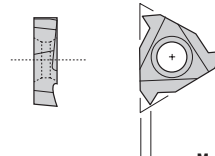

Description	EDP Code	TPI	M	C22	GP22	GP4	AC22	AC4
BFR3-18NPT	9BFR3V18	18	0.84		●	●		
BFR3-27NPT	9BFR3V27	27	0.66		●	●		

THREADING - ISO BFR3

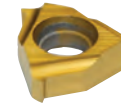
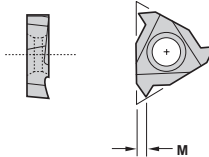

Description	EDP Code	TPI	C22	GP22	GP4	AC22	AC4
BFR3-0.75 ISO	9BFR3I75	0.75			●		
BFR3-1.0 ISO	9BFR3I10	1.00			●		
BFR3-1.5 ISO	9BFR3I15	1.50			●		
BFR3-1.75 ISO	9BFR3I175	1.75			●		

THREADING - UN BFR3

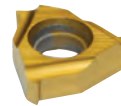
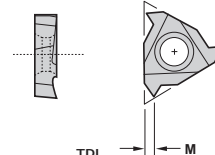

Description	EDP Code	TPI	M	C22	GP22	GP4	AC22	AC4
BFR3-20UN	9BFR3U20	20	0.66			●		
BFR3-24UN	9BFR3U24	24	0.66			●		
BFR3-28UN	9BFR3U28	28	0.53			●		
BFR3-32UN	9BFR3U32	32	0.48		●	●		

THREADING - 55°/60° V BFR3

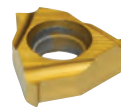
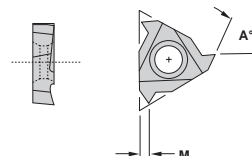

Description	EDP Code	TPI	M	A	C22	GP22	GP4	AC22	AC4
BFR3-55V	9BFR3V55	0.5-1.2	0.71	55°			●		
BFR3-60V	9BFR3V60	27-48	0.79	60°			●		

In an effort to improve our stock standard grade offering, there are periodic changes. Please see current price list for up to date grade offering.

- High performance choice in optimal conditions.
- ▲ Recommended grade under general conditions.

	Uncoated	TIN Coated	AITIN Coated
Cast Iron		●	
Non-Ferrous		●	
Stainless/High Temp		●	
Steel	●		

BFRM3

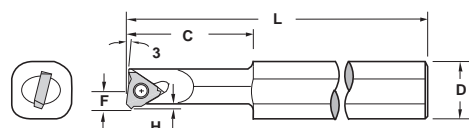

Description	EDP Code	Material	Insert	Coolant Port	L	D	C	H	F	Min. Bore	Screw*
BFRM-7.9S	9BFM79S	Steel	BFR3		127.00	12.00	12.70	1.27	3.81	7.92	TS25
BFRM-7.9SC	9BFM79SC	Steel	BFR3	✓	127.00	12.00	12.70	1.27	3.81	7.92	TS25
BFRM-7.9HM	9BFM79HM	Heavy Metal	BFR3		127.00	12.00	31.75	1.27	3.81	7.92	TS25
BFRM-7.9HMC	9BFM79HMC	Heavy Metal	BFR3	✓	127.00	12.00	31.75	1.27	3.81	7.92	TS25

*TS25 screw uses K2 wrench



MINIMUM BORE 7.92 - 11.2

THREADING - NPT
BNVR/L

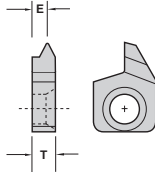

C22	GP22	GP4	AC22	AC4	Uncoated	TIN Coated	AITIN Coated
●	●	●					
●	●	●					
●	●	●					
●	●	●					
●	●	●					
●	●	●					

Description	EDP Code	TPI	E	T	C22	GP22	GP4	AC22	AC4
BNVR-14NPT	9BNP14R	14	1.02	3.48	●	●	●		
BNVL-14NPT	9BNP14L	14	1.02	3.48	●	●	●		
BNVR-18NPT	9BNP18R	18	0.76	3.48	●	●	●		
BNVL-18NPT	9BNP18L	18	0.76	3.48	●	●	●		
BNVR-27NPT	9BNP27R	27	0.76	3.48	●	●	●		
BNVL-27NPT	9BNP27L	27	0.76	3.48	●	●	●		

MINIMUM BORE 7.92 - 11.2

THREADING - UN
BNVR/L

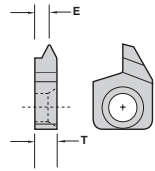

C22	GP22	GP4	AC22	AC4	Uncoated	TIN Coated	AITIN Coated
●	●	●					
●	●	●					
●	●	●					
●	●	●					
●	●	●					
●	●	●					
●	●	●					
●	●	●					
●	●	●					
●	●	●					

Description	EDP Code	TPI	E	T	C22	GP22	GP4	AC22	AC4
BNVR-12UN	9BNV12R	12	1.02	3.48	●	●	●		
BNVL-12UN	9BNV12L	12	1.02	3.48	●	●	●		
BNVR-16UN	9BNV16R	16	0.79	3.48	●	●	●		
BNVL-16UN	9BNV16L	16	0.79	3.48	●	●	●		
BNVR-18UN	9BNV18R	18	0.79	3.48	●	●	●		
BNVL-18UN	9BNV18L	18	0.79	3.48	●	●	●		
BNVR-20UN	9BNV20R	20	0.76	3.48	●	●	●		
BNVL-20UN	9BNV20L	20	0.76	3.48	●	●	●		
BNVR-24UN	9BNV24R	24	0.76	3.48	●	●	●		
BNVL-24UN	9BNV24L	24	0.76	3.48	●	●	●		
BNVR-28UN	9BNV28R	28	0.76	3.48	●	●	●		
BNVL-28UN	9BNV28L	28	0.76	3.48	●	●	●		
BNVR-32UN	9BNV32R	32	0.76	3.48	●	●	●		
BNVL-32UN	9BNV32L	32	0.76	3.48	●	●	●		

THREADING - 60° V BNVR/L

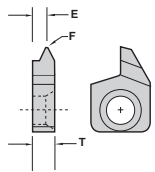

GFI	C22	GP22	GP4	AC22	AC4	Uncoated	TIN Coated	AITIN Coated
●	●	●	●					
●	●	●	●					
			●					
			●					
			●					
			●					

Description	EDP Code	TPI	F	E	T	GFI	C22	GP22	GP4	AC22	AC4
BNVR-60	9BNV60R	0.6-1.4	0.08F	2.41	3.48	●	●	●	●		●
BNVL-60	9BNV60L	0.6-1.4	0.08F	2.41	3.48	●	●	●	●		●

In an effort to improve our stock standard grade offering, there are periodic changes. Please see current price list for up to date grade offering.

- High performance choice in optimal conditions.
- ▲ Recommended grade under general conditions.

Cast Iron			●		
Non-Ferrous			●		
Stainless/High Temp			●		
Steel			●		

BB

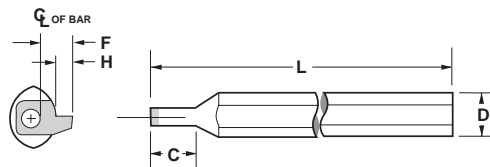

Description	EDP Code	Material	Insert	L	D	C	F	H	Min. Bore	Screw*
BBM-7.9S	9BM79S	Steel	BN_R/L	127.00	12.00	19.05	3.96	1.78	7.92	TS25
BBM-8.7S	9BM87S	Steel	BN_R/L	127.00	12.00	19.05	3.86	1.78	8.74	TS25
BBM-9.5S	9BM95S	Steel	BN_R/L	127.00	12.00	19.05	4.13	1.78	9.53	TS25
BBM-11.1S	9BM111S	Steel	BN_R/L	127.00	12.00	25.40	4.83	1.78	11.18	TS25
BBM-7.9HM	9BM79HM	Heavy Metal	BN_R/L	127.00	12.00	25.40	3.96	1.78	7.92	TS25
BBM-8.7HM	9BM87HM	Heavy Metal	BN_R/L	127.00	12.00	25.40	3.86	1.78	8.74	TS25
BBM-9.5HM	9BM95HM	Heavy Metal	BN_R/L	127.00	12.00	31.75	4.13	1.78	9.53	TS25
BBM-11.1HM	9BM111HM	Heavy Metal	BN_R/L	127.00	12.00	38.10	4.83	1.78	11.18	TS25
BBM-7.9C	9BM79C	Carbide	BN_R/L	127.00	12.00	31.75	3.96	1.78	7.92	TS25
BBM-11.1C	9BM111C	Carbide	BN_R/L	127.00	12.00	38.10	4.83	1.78	11.18	TS25

*TS25 screw uses K2 wrench



MINIMUM BORE 11.1 THREADING - NPT BFR4

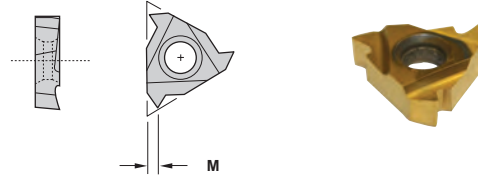

Description	EDP Code	TPI	M	Coating				
				C22	GP22	GP4	AC22	AC4
BFR4-18NPT	9BFR4V18	18	0.84		●			
BFR4-27NPT	9BFR4V27	27	0.66		●			

THREADING - ISO BFR4

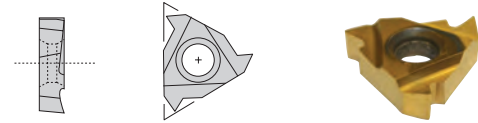

Description	EDP Code	TPI	Coating				
			C22	GP22	GP4	AC22	AC4
BFR4-2.0 ISO	9BFR4I20	2.00		●			
BFR4-1.75 ISO	9BFR4I175	1.75		●			
BFR4-1.50 ISO	9BFR4I15	1.50		●			
BFR4-1.25 ISO	9BFR4I125	1.25		●			
BFR4-1.0 ISO	9BFR4I10	1.00		●			
BFR4-0.75 ISO	9BFR4I075	0.75		●			

THREADING - UN BFR4

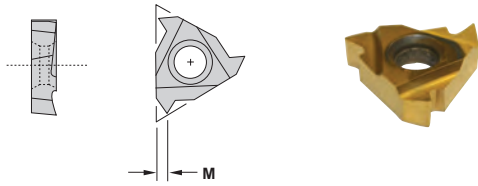

Description	EDP Code	TPI	M	Coating				
				C22	GP22	GP4	AC22	AC4
BFR4-12UN	9BFR4U12	12	1.09		●			
BFR4-14UN	9BFR4U14	14	0.99		●			
BFR4-16UN	9BFR4U16	16	0.86		●			
BFR4-20UN	9BFR4U20	20	0.66		●			
BFR4-24UN	9BFR4U24	24	0.66		●			
BFR4-28UN	9BFR4U28	28	0.53		●			
BFR4-32UN	9BFR4U32	32	0.48		●			

THREADING - 55°/60° V BFR4

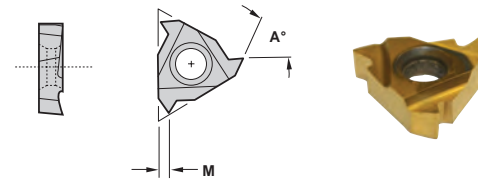

Description	EDP Code	TPI	M	A	Coating				
					C22	GP22	GP4	AC22	AC4
BFR4-55V	9BFR4V55	0.5-1.8	1.09	55°		●	▲		
BFR4-60V	9BFR4V60	0.5-1.8	1.09	60°		●	▲		

In an effort to improve our stock standard grade offering, there are periodic changes. Please see current price list for up-to-date grade offering.

- High performance choice in optimal conditions.
- ▲ Recommended grade under general conditions.

Material	C22	GP22	GP4	AC22	AC4
Cast Iron		●	▲		
Non-Ferrous		●	▲		
Stainless/High Temp		●	▲		
Steel		●	▲		

BFR4

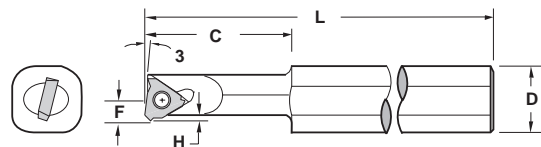

Description	EDP Code	Material	Insert	Coolant		L	D	C	H	F**	Min. Bore	Screw*
				Port	L							
BFRM-10.1S	9BFM101S	Steel	BFR4			127.00	12.00	25.40	1.27	6.02	10.16	TS25
BFRM-10.1SC	9BFM101SC	Steel	BFR4	✓		127.00	12.00	25.40	1.27	6.02	10.16	TS25
BFRM-10.1HM	9BFM101HM	Heavy Metal	BFR4			127.00	12.00	25.40	1.27	6.02	10.16	TS25
BFRM-10.1HMC	9BFM101HMC	Heavy Metal	BFR4	✓		127.00	12.00	25.40	1.27	6.02	10.16	TS25

*TS25 screw uses K2 wrench
** Dimension over sharp point



MINIMUM BORE 11.43

THREADING - ACME

BHR4



Description	EDP Code	TPI	W	Coating				
				C22	GP22	GP4	AC22	AC4
BHR4-8ACME	9BHA080R	8	1.04			●		
BHR4-10ACME	9BHA100R	10	0.81			●		
BHR4-12ACME	9BHA120R	12	0.72			●		
BHR4-16ACME	9BHA160R	16	0.52			●		

THREADING - STUB ACME

BHR4



Description	EDP Code	TPI	W	Coating				
				C22	GP22	GP4	AC22	AC4
BHR4-8STACME	9BHA081R	8	1.21			●		
BHR4-10STACME	9BHA101R	10	0.94			●		
BHR4-12STACME	9BHA121R	12	0.83			●		
BHR4-16STACME	9BHA161R	16	0.60			●		

THREADING - 60° V

BHR4

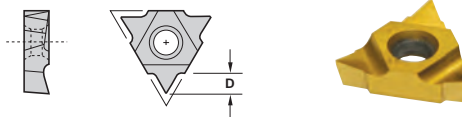

Description	EDP Code	TPI	D	C22	GP22	GP4	AC22	AC4
BHR4-60V	9BH460R	0.5-1.6	1.91			●		

In an effort to improve our stock standard grade offering, there are periodic changes. Please see current price list for up to date grade offering.

● High performance choice in optimal conditions.
▲ Recommended grade under general conditions.

Material	C22	GP22	GP4	AC22	AC4
Cast Iron		●	▲		
Non-Ferrous		●	▲		
Stainless/High Temp		●	▲		
Steel		●	▲		

BHR4

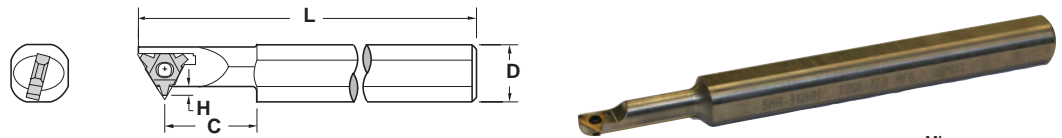

Description	EDP Code	Material	Insert	L	D	C	H	Min. Bore	Screw
BHRM-11.4S	9BHRM114S	Steel	BHR4	127.00	12.00	25.40	1.91	11.43	TS25
BHRM-11.4HM	9BHRM114HM	Heavy Metal	BHR4	127.00	12.00	25.40	1.91	11.43	TS25

MINIMUM BORE 12.7

THREADING - 60° V

BTVR/L

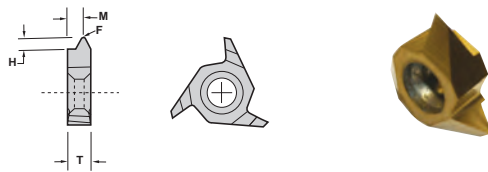

Description	EDP Code	TPI	M	H	T	F	Coating					
							C22	GP22	GP4	AC22	AC4	
BTVR-60	9BTV60R	0.4-1.4	1.19	1.91	3.30	0.10		●	●			
BTVL-60	9BTV60L	0.4-1.4	1.19	1.91	3.30	0.10		●	●			

In an effort to improve our stock standard grade offering, there are periodic changes. Please see current price list for up to date grade offering.

● High performance choice in optimal conditions.
▲ Recommended grade under general conditions.

Material	C22	GP22	GP4	AC22	AC4
Cast Iron		●	▲		
Non-Ferrous		●	▲		
Stainless/High Temp		●	▲		
Steel		●	▲		

BTR/L

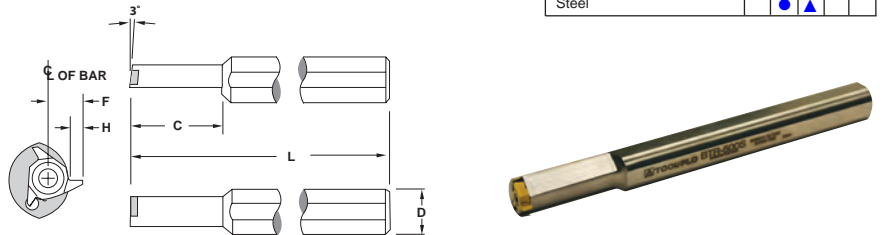

Description	EDP Code	Material	Insert	L	D	C	H	F	Min. Bore	Screw*
BTRM-12.7S	9BTRM127S	Steel	BTVR	127.00	12.00	31.75	1.91	5.72	12.70	TS25
BTLM-12.7S	9BTLM127S	Steel	BTVL	127.00	12.00	31.75	1.91	5.72	12.70	TS25
BTRM-12.7HM	9BTRM127HM	Heavy Metal	BTVR	127.00	12.00	38.10	1.91	5.72	12.70	TS25
BTLM-12.7HM	9BTLM127HM	Heavy Metal	BTVL	127.00	12.00	38.10	1.91	5.72	12.70	TS25

*TS25 screw uses K2 wrench



MINIMUM BORE 13.1 CIRCULAR INTERPOLATING MILLGROOVING BNGR

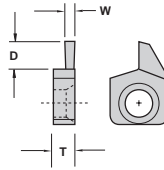

Description	EDP Code	W	D	T	Coatings							
					C22	Uncoated	TIN Coated	GP22	GP4	AC22	AC4	
BNGR-031W	9BG031R	0.79	1.27	3.48								
BNGR-047W	9BG047R	1.19	1.78	3.48								
BNGR-062W	9BG062R	1.57	1.78	3.48								
BNGR-094W	9BG094R	2.39	1.78	3.48								
BNGR-125W	9BG125R	3.18	1.78	3.48								

BANTAM

THREADMILLING BNVR

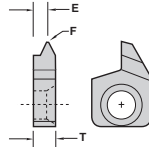

Description	EDP Code	TPI	F	E	T	Coatings				
						GFI	GP22	GP4	AC22	AC4
BNVR-60	9BNV60R	18-40	0.08F	2.41	3.48					
BNVL-60	9BNV60L	18-40	0.08F	2.41	3.48					

In an effort to improve our stock standard grade offering, there are periodic changes. Please see current price list for up to date grade offering.

- High performance choice in optimal conditions.
- ▲ Recommended grade under general conditions.

Material	GFI	GP22	GP4	AC22	AC4
Cast Iron			●		
Non-Ferrous			●		
Stainless/High Temp			●		
Steel			●		

CIRCULAR INTERPOLATING THREADMILLING & MILLGROOVING BBC

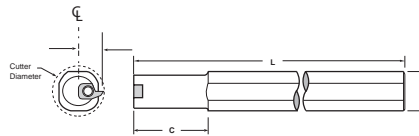

Description	EDP Code	Material	Insert	L	D	C	Min. Dia.	Cutter Dia.	Screw*
BBCM-13.1S	9BCM131S	Steel	BN_R/L	127.00	12.00	31.75	20.32	13.11	TS25
BBCM-13.1HM	9BCM131HM	Heavy Metal	BN_R/L	127.00	12.00	38.10	20.32	13.11	TS25

*TS25 screw uses K2 wrench

Bantam Series Kits THREADING KITS

V-THREADING KIT #1

Kit Contents

1	BFRM-7.9S
10	BFR3-60V GP22
1	T8 WRENCH
1	TS25 SCREW

18NPT-THREADING KIT #2

Kit Contents

1	BFRM-7.9S
10	BFR3-18NPT GP22
1	T8 WRENCH
1	TS25 SCREW

27NPT-THREADING KIT #3

Kit Contents

1	BFRM-7.9S
10	BFR3-27NPT GP22
1	T8 WRENCH
1	TS25 SCREW

GROOVING KITS W.031 GROOVING KIT #4

Kit Contents

1	BBM-7.9S
10	BNGR-031W GP4
1	T8 WRENCH
1	TS25 SCREW

W.047 GROOVING KIT #5

Kit Contents

1	BBM-7.9S
10	BNGR-047W GP4
1	T8 WRENCH
1	TS25 SCREW

W.062 GROOVING KIT #6

Kit Contents

1	BBM-7.9S
10	BNGR-062W GP4
1	T8 WRENCH
1	TS25 SCREW

BORING KITS .180 MIN BORE KIT #7

Kit Contents

1	CSBM-42/5-60-7R
10	CDCG-505L GP22
1	T6 WRENCH
1	TS1 SCREW

.285 MIN BORE KIT #8

Kit Contents

1	CSBM-6-80-5R
10	CDCG-505L GP22
1	T6 WRENCH
1	TS1 SCREW





Technical Information

BANTAM

SURFACE METERS PER MINUTE (SM/M)

Tool-Flo grade	uncoated		TiN coated		AlTiN coated	
	GFI	C22	GP4	GP22	AC4	AC22
Alloy Steel 4000 Series	18.29 - 36.58			30.48 - 76.20	30.48 - 54.86	60.96 - 152.40
Aluminum		24.38 - 60.96		60.96 - 121.92		91.44 - 182.88
Carbon Steel		24.38 - 45.72		24.38 - 60.96	30.48 - 64.01	60.96 - 152.40
Ductile Iron	18.29 - 36.58			30.48 - 76.20		60.96 - 152.40
Non Metals	18.29 - 36.58	24.38 - 45.72	18.29 - 45.72	60.96 - 121.92		91.44 - 182.88
Stainless Steel 300 Series	18.29 - 36.58	24.38 - 45.72	18.29 - 45.72	30.48 - 76.20	24.38 - 54.86	45.72 - 106.68
Stainless Steel 400 Series	18.29 - 36.58		18.29 - 45.72	30.48 - 91.44	24.38 - 54.86	60.96 - 152.40

FEED RATE (MM/REV)

Application	THREADING	GROOVING	BORING
Alloy Steel 4000 Series	Set by pitch (DOC per pass= 0.051-0.102)	MM/R=0.051-0.102	0.051-0.102
Aluminum Non-Metals	Set by pitch (DOC per pass= 0.102-0.152)	MM/R=0.102-0.152	0.102-0.152
Carbon Steel	Set by pitch (DOC per pass= 0.051-.102)	MM/R=0.051-0.102	0.051-0.102
300Stainless Steel High Temp Alloys	Set by pitch (DOC per pass= 0.051-.102)	MM/R=0.051-0.102	0.051-0.102
Stainless Steel 400 Series	Set by pitch (DOC per pass= 0.051-0.102)	MM/R=0.051-0.102	0.051-0.102

CUTTING DATA

TOOL-FLO MFG, on all threading and grooving bars, sets the cutting edge of inserts above centerline. This decreases the deflection reducing the load on the insert. The result is a better finish with less chatter. We recommend following the same procedure for boring operations.

*When using the BB-312S/HM bar with a grooving insert .062 wide or greater, reduce the recommended MM/REV by 50%.

GRADE CROSSOVER CHART

TOOL-FLO	CIRCLE	EVEREDE
C22	C2,C3,C25	CS2,CM2
GFI	C50	CS-4, CS-6, CS-7
GP22	CG5/CM-10	CVM-2, CV-7
GP4	C-4	CT-7
AC22	CG6	CA2
AC4	C70	CC-7



EXTERNAL HOLDER

THREADING, GROOVING
FLASR/L

Design for Swiss machines

SEE FLO-LOCK SECTION FOR COMPLETE INSERT OFFERING

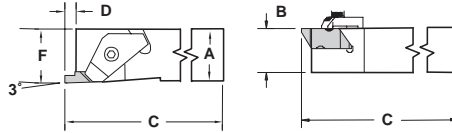

RH SHOWN
RH Holder uses RH Inserts

BANTAM

Coolant Clamp available
(See page 60)

Description	EDP Code	Insert	A	B	C	D	F	Clamp	Clamp Screw
FLASR-1010M2	92711008	FL_-2R	10.0	10.0	150.0	3.51	10.0	TF-182	SSM51
FLASL-1010M2	92661008	FL_-2L	10.0	10.0	150.0	3.51	10.0	TF-183	SSM51
FLASR-1212M2	92711208	FL_-2R	12.0	12.0	150.0	3.51	12.0	TF-182	SSM51
FLASL-1212M2	92661208	FL_-2L	12.0	12.0	150.0	3.51	12.0	TF-183	SSM51
FLASR-1616M2	92711608	FL_-2R	16.0	16.0	150.0	3.51	16.0	TF-184	SSM51
FLASR-1616M3	92711616	FL_-3R	16.0	16.0	125.0	5.31	16.0	TF-184	SSM51
FLASL-1616M3	92661616	FL_-3L	16.0	16.0	125.0	5.31	16.0	TF-185	SSM51

EXTERNAL HOLDER

THREADING, GROOVING
AL

Design for Swiss machines

SEE LAYDOWN SECTION FOR COMPLETE INSERT OFFERING

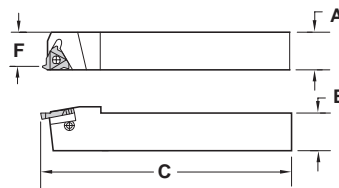

RH SHOWN
RH Holder uses RH Inserts

Description	EDP Code	Insert	A	B	C	F	Insert Screw	Seat Screw	Wrench	Seat
AL0808M2R	916108321	11ER	8.0	8.0	100.0	11.0	SAM3	---	K2	---
AL1010M2R	916110321	11ER	10.0	10.0	100.0	10.0	SAM3	---	K2	---
AL1616M3R	916116361	16ER	16.0	16.0	100.0	16.0	SAM3	SYM3	K3	YE3
AL1616M3L	916116362	16EL	16.0	16.0	100.0	16.0	SAM3	SYM3	K3	YI3
AL2020M3R	916120361	16ER	20.0	20.0	128.6	20.0	SAM3	SYM3	K3	YE3
AL2020M3L	916120362	16EL	20.0	20.0	128.6	20.0	SAM3	SYM3	K3	YI3
AL2525M3R	916125361	16ER	25.0	25.0	153.6	25.0	SAM3	SYM3	K3	YE3
AL2525M3L	916125362	16EL	25.0	25.0	153.6	25.0	SAM3	SYM3	K3	YI3

Coolant-Fed Clamps

Patent pending

Can be used with low pressure
or high pressure coolant
(rated up to 1500 psi)



Use Your Existing Holders!

Simply replace the top clamp on your standard holder.

Coolant Fed Clamps For FLRS/L and FLASR holders

TF-CP

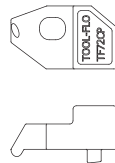

TF72CP
shown

Clamp	EDP Code	Toolholder	Insert
TF72CP	9HTF72CP	FLSR-__3/4	FL_-3R/4R
TF73CP	9HTF73CP	FLSL-__3/4	FL_-3L/4L
TF74CP	9HTF74CP	FLSR-__2	FL_-2R
TF75CP	9HTF75CP	FLSL-__2	FL_-2L
TF182CP	9HTF182CP	FLASR-__2	FL_-2R
TF184CP	9HTF183CP	FLASR-__3	FL_-3R

Fittings

6mm & 1/8"



M6 x 1 elbow
(Connection to machine)



M6 x 1 straight
(Connection to machine)



1/8" (.125) NPT elbow
(Connection to clamp)



1/8" (.125) NPT straight
(Connection to clamp)

Description	EDP Code	Fitting/Thread size
M6X1 ELBOW COOLANT FITTING	9HCPM6X190	6mm x 1.0 (Connection to machine)
M6X1 STRAIGHT COOLANT FITTING	9HCPM6X1	6mm x 1.0 (Connection to machine)
1/8" NPT ELBOW COOLANT FITTING	9HCP12590NPT	1/8" (.125) x 27 NPT (Connection to clamp)
1/8" NPT STRAIGHT COOLANT FITTING	9HCP125NPT	1/8" (.125) x 27 NPT (Connection to clamp)

High Pressure Coolant Hose

6mm

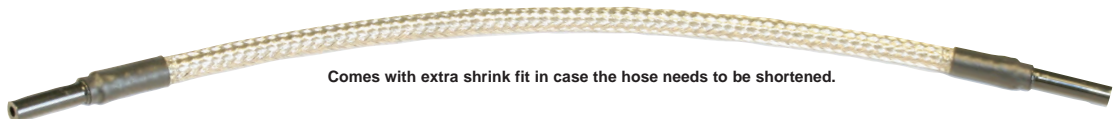

Comes with extra shrink fit in case the hose needs to be shortened.

Description	EDP Code	Size	Length
6MM HIGH PRESSURE COOLANT HOSE	9HCP6MHOSEHP	6mm	12"



CHASERS

Oil & Gas



Chaser Insert Nomenclature Chart

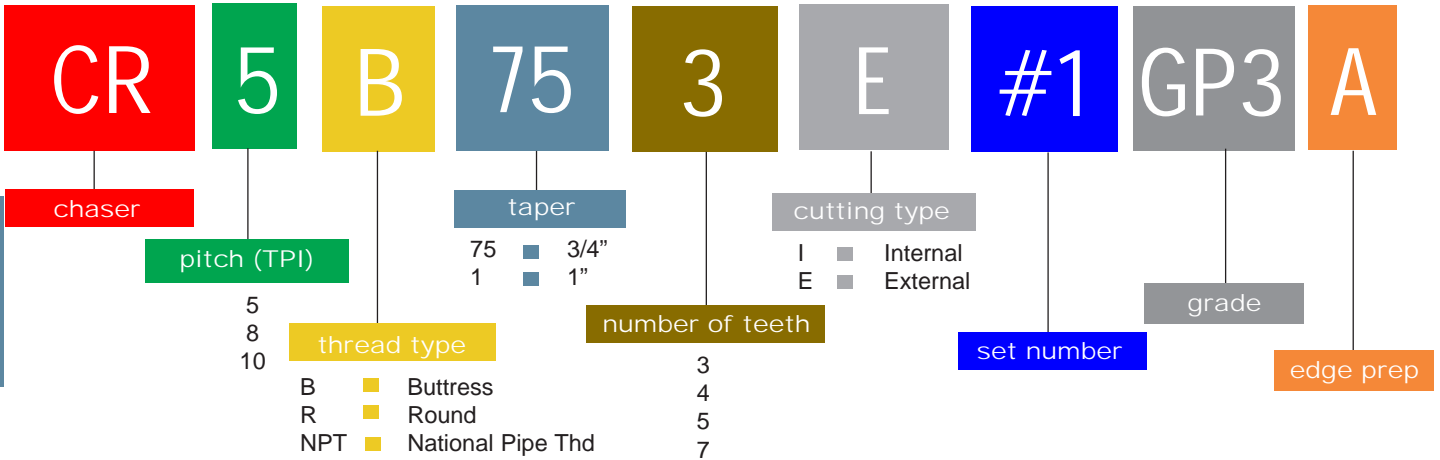

API BUTTRESS External

For holders see pg. 64

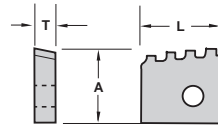

Description	EDP Code	TPI	TPF	L	A	T	No. of Teeth	Coating			
								G50	GP50	ZA3	AC50
CR-5B75-3E #1	M16415188	5	3/4	17.02	14.55	5.21	3	●	●	●	●
CR-5B75-3E #2	M16415189	5	3/4	17.02	14.78	5.21	3	●	●	●	●
CR-5B75-3E #3	M16426149	5	3/4	17.02	14.99	5.21	3	●	●	●	●
CR-5B75-4E	M16422675	5	3/4	20.42	15.88	5.08	4	●	●	●	●
CR-5B1-4E	M1741130	5	1	20.32	16.26	5.08	4	●	●	●	●
CR-8B75-4E	M2145353	8	3/4	20.32	15.37	5.08	4	●	●	●	●

Internal

For bars see pg. 64

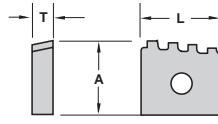

Description	EDP Code	TPI	TPF	L	A	T	No. of Teeth	Coating			
								G50	GP50	ZA3	AC50
CR-5B75-2I	M16828936	5	3/4	16.00	15.80	5.18	2	●	●	●	●
CR-5B75-3I	M1681847	5	3/4	16.00	14.66	5.18	3	●	●	●	●
CR-5B75-4I	M1681347	5	3/4	20.32	14.78	5.21	4	●	●	●	●
CR-5B75-5I	M16815688	5	3/4	25.40	14.99	5.21	5	●	●	●	●
CR-5B1-3I	M1782052	5	1	16.13	16.13	5.08	3	●	●	●	●
CR-5B1-4I	M1782051	5	1	20.32	16.26	5.08	4	●	●	●	●
CR-8B75-4I	M2185353	8	3/4	20.32	14.99	5.21	4	●	●	●	●

API ROUND External

For holders see pg. 64

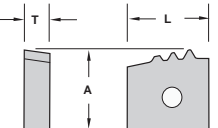

Description	EDP Code	TPI	TPF	L	A	T	No. of Teeth	Coating		
								G50	GP50	AC50
CR-8R-3E #1	M32416731	8	3/4	16.00	14.66	5.18	3	●	●	●
CR-8R-3E #2	M32416732	8	3/4	16.00	14.88	5.18	3	●	●	●
CR-8R-3E #3	M32416733	8	3/4	16.00	15.01	5.18	3	●	●	●
CR-8R-3E	M32419310	8	3/4	16.00	15.04	5.18	3	●	●	●
CR-8R-4E 6°	M3241136	8	3/4	16.26	15.88	5.08	4	●	●	●
CR-8R-4E 12°	M3241163	8	3/4	16.13	15.88	5.08	4	●	●	●
CR-10R-3E #1	M34416728	10	3/4	15.95	14.30	5.18	3	●	●	●
CR-10R-3E #2	M34416729	10	3/4	15.95	14.53	5.18	3	●	●	●
CR-10R-3E #3	M34416730	10	3/4	15.95	14.61	5.18	3	●	●	●
CR-10R-3E	M3441291	10	3/4	16.00	15.88	5.18	3	●	●	●

API ROUND & BUTTRESS External

CNGA - Double Sided (2 cutting edges)

For holders see pg. 64

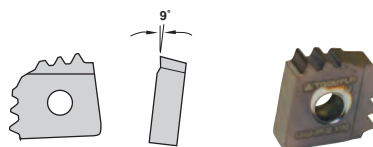

Description	EDP Code	TPI	TPF	No. of Teeth	Coating			
					G50	GP50	ZA3	AC50
CNGA-8R-3E	M32427407	8	3/4	3	●	●	●	●
CNGA-10R-3E	M34427408	10	3/4	3	●	●	●	●
CNGA-5B75-3E	M16427408	5	3/4	3	●	●	●	●



CHASERS

API ROUND Internal

■ For bars see pg. 64

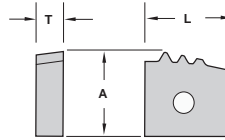

Description	EDP Code	TPI	TPF	L	A	T	No. of Teeth	Coatings		
								G50	GP50	AC50
CR-8R-3I	M3287464	8	3/4	16.00	15.04	5.18	3	●	●	●
CR-8R-4I	M3281136	8	3/4	16.13	15.88	5.18	4	●	●	●
CR-8R-4I	M32825150	8	3/4	16.26	15.88	5.18	4	●	●	●
CR-8R-7I	M32814828	8	3/4	25.40	15.88	5.18	7	●	●	●
CR-8R-7I	M32817968	8	3/4	25.40	15.88	5.18	7	●	●	●
CR-10R-3I	M3481291	10	3/4	16.00	15.88	5.18	3	●	●	●

CVD Coated	TIN Coated	AlTiN Coated
●	●	●
●	●	●
●	●	●
●	●	●
●	●	●
●	●	●

CHASERS

NPT/LPT External

■ For holders see pg. 64

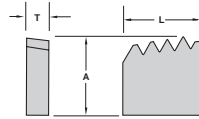

Description	EDP Code	TPI	TPF	L	A	T	No. of Teeth	Coatings			
								G50	GP50	AC3	AC50
CR-8NPT-4E	M3648996	8	3/4	16.00	15.75	5.18	4	●	●	●	●
CR-11.5NPT-4E	M3649668	11.5	3/4	15.88	15.75	4.76	4	●	●	●	●
CR-8P-3E WW	M50938966	8	0	16.00	15.04	5.18	3	●	●	●	●

G50	GP50	AC3	AC50
●	●	●	●
●	●	●	●
●	●	●	●

Internal

■ For bars see pg. 64

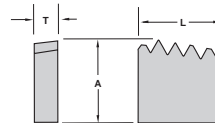

Description	EDP Code	TPI	TPF	L	A	T	No. of Teeth	Coatings			
								G50	GP50	AC3	AC50
CR-8NPT-4I	M3689804	8	3/4	15.88	15.75	5.18	4	●	●	●	●
CR-11.5NPT-4I	M36823951	11.5	3/4	15.88	15.75	4.76	4	●	●	●	●
CR-8NPT-7I	M36817755	8	3/4	25.40	15.62	5.08	7	●	●	●	●
CR-8P-3 WW	M50828192	8	0	15.88	15.04	5.18	3	●	●	●	●

G50	GP50	AC3	AC50
●	●	●	●
●	●	●	●
●	●	●	●
●	●	●	●

In an effort to improve our stock standard grade offering, there are periodic changes. Please see current price list for up to date grade offering.

● High performance choice in optimal conditions.
▲ Recommended grade under general conditions.

J-Series	▲	▲	▲	▲
K-Series	▲	▲	▲	▲
L-Series	▲	▲	▲	▲
N-Series	▲	▲	▲	▲
P-Series	▲	▲	▲	▲
Q-Series	▲	▲	▲	▲

CHIPBREAKERS External

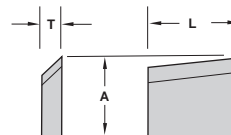

Description	EDP Code	L	A	T	Inserts
CR-5B75/5B1-4E-CB	TF2993	20.32	12.70	3.18	CR-5B75-4E/CR-5B1-4E
CR-8R/10R-3E/4E-CB	TF1353E	15.88	11.68	3.05	CR-8R-3E/CR-8R-4E/CR-10R-3E/CR-8NPT-4E
#3 CB without COOLANT GROOVES .170	TF26424	15.70	11.68	4.32	CR-8R-3E/CR-8R-4E/CR-10R-3E/CR-8NPT-4E

External with coolant grooves

Also available at -0.25, -0.50 and -0.76 off the A dimension.

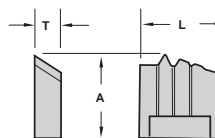

Description	EDP Code	L	A	T	Coolant Grooves	Inserts
TD4601 5B75-1-CB	TF16660	16.89	13.46	4.32	✓	CR-5B75-3E #1
TD4602 5B75-2-CB	TF16661	16.97	13.79	4.32	✓	CR-5B75-3E #2
TD4603 5B75-3-CB	TF16662	16.89	14.05	4.32	✓	CR-5B75-3E #3
TD3931 8R-1-CB	TF16657	15.95	13.16	4.45	✓	CR-8R-3E #1
TD3932 8R-2-CB	TF16658	16.13	13.36	4.45	✓	CR-8R-3E #2
TD3933 8R-3-CB	TF27129	16.00	13.72	4.45	✓	CR-8R-3E #3
TA2237 10R-1-CB	TF16760	15.95	12.78	4.45	✓	CR-10R-3E #1
TA2238 10R-2-CB	TF16761	15.95	13.00	4.45	✓	CR-10R-3E #2
TA2239 10R-3-CB	TF16762	15.95	13.08	4.45	✓	CR-10R-3E #3
#3 CB W/COOLANT GROOVES .170	TF26423	15.70	11.68	4.32	✓	CR-8R-3E



CHIPBREAKER

External with coolant grooves and cavity

Also available at **-0.25, -0.50 and -0.76**
off the A dimension.

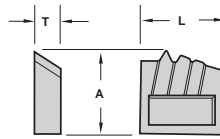

Description	EDP Code	L	A	T	Coolant Grooves	Inserts
TD4601 5B75-1-CB W/CAVITY	TF30297	16.89	13.97	4.32	✓	CR-5B75-3E #1
TD4602 5B75-2-CB W/CAVITY	TF30298	16.97	13.97	4.32	✓	CR-5B75-3E #2
TD4603 5B75-3-CB W/CAVITY	TF30299	16.89	14.22	4.32	✓	CR-5B75-3E #3
TD3931 8R-1-CB W/CAVITY	TF28130	15.95	13.16	4.19	✓	CR-8R-3E #1
TD3932 8R-2-CB W/CAVITY	TF28131	16.13	13.36	4.19	✓	CR-8R-3E #2
TD3933 8R-3-CB W/CAVITY	TF28132	15.95	13.21	4.19	✓	CR-8R-3E #3

Internal

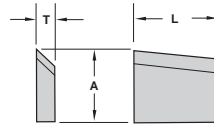

Description	EDP Code	L	A	T	Coolant Grooves	Inserts
CR-5B75/5B1-4I-CB	TF16104	20.32	12.70	3.18		CR-5B75-4I/CR-5B1-4I
CR-8R/10R-3I/4I-CB	TF1353I	16.00	12.40	3.18		CR-8R-3I/CR-8R-4I/CR-10R-3I/CR-8LPT-4I
CR-5B75-5I-CB	TF28765	25.40	13.72	3.18	✓	CR-5B75-5I
CR-8R-7I-CB	TF3435	25.40	13.21	3.18		CR-8R-7I
CR-8R-7I-CB	TF18096	25.65	13.72	3.18	✓	CR-8R-7I

EXTERNAL HOLDER

Threading
CLVOR

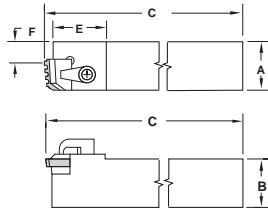

Description	EDP Code	Insert	A	B	C	E	F	Seat	Seat Screw	Clamp	Clamp Screw	Chip Breaker
CLVOR-25M6	9260M2594	3 TOOTH*	25	25	170	32	16.10	TF1207	SFM80	CLM12	XNSM-0825	TF1353#
CLVOR-32M6	9260M3294	3 TOOTH*	32	32	170	32	16.10	TF1207	SFM80	CLM12	XNSM-0825	TF1353#
CLVOR-40M6	9260M4094	3 TOOTH*	40	40	170	32	20.32	TF1207	SFM85	CLM12	XNSM-0825	TF1353#
CLVOR-25M8	9260M2596	4 TOOTH**	25	25	170	32	20.32	TF8132E	SFM80	CLM12	XNSM-0825	TF2993#
CLVOR-32M8	9260M3296	4 TOOTH**	32	32	170	32	20.32	TF8132E	SFM60	CLM12	XNSM-0825	TF2993#
CLVOR-40M8	9260M4096	4 TOOTH**	40	40	170	32	20.32	TF8132E	SFM60	CLM12	XNSM-0825	TF2993#

*Accepts 3 & 4 Tooth RD, NPT, and 3 Tooth Buttress **Accepts 4 Tooth Buttress Only
#Chipbreakers sold separately.

PCFNR

For double sided CNGA chaser style

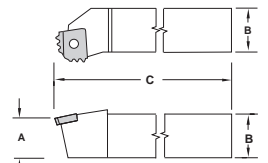

RH SHOWN

Description	EDP Code	Insert	A	B	C	Lock Pin	Clamp	Clamp Screw
PCFNR-25M5	963025M64	CNGA 8R/10R/5B75-3E	25	25	150	NL-44	TC250	STC-11
PCFNR-32M5	963032M64	CNGA 8R/10R/5B75-3E	32	32	150	NL-44	TC250	STC-11

INTERNAL BAR

Threading
SI-CLHOR

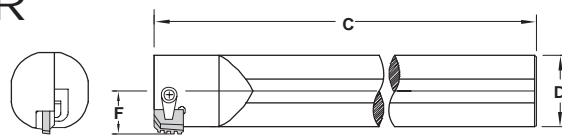

Description	EDP Code	Insert	D	F	C	Min. Bore	Seat	Seat Screw	Clamp	Clamp Screw
SI-CLHOR-32M6	970032M94	CR-8R-3I	32	19.1	350	38.1	-	-	CLM12	STCM-8
		CR-8R-4I	32	19.1	350	38.1	-	-	CLM12	STCM-8
		CR-5B75-3I	32	19.1	350	38.1	-	-	CLM12	STCM-8
SI-CLHOR-40M6	970040M94	CR-8R-3I	40	23.16	400	50.8	-	-	CLM12	STCM-8
		CR-8R-4I	40	23.16	400	50.8	-	-	CLM12	STCM-8
		CR-5B75-3I	40	23.16	400	50.8	-	-	CLM12	STCM-8
SI-CLHOR-50M6	970050M94	CR-8R-3IDC	50	28.6	350	57.2	TF1780I	SFM60	CLM12	STCM-8
SI-CLHOR-50M8	970050M96	CR-5B1-4I	50	28.6	350	57.2	TF8132I	SFM60	CLM12	STCM-8
		CR-5B75-4I	50	28.6	350	57.2	TF8132I	SFM60	CLM12	STCM-8
		CR-8B75-4I	50	28.6	350	57.2	TF8132I	SFM60	CLM12	STCM-8
SI-CLHOR-60M8	970060M96	CR-5B1-4I	60	34.9	350	69.9	TF8132I	SFM60	CLM12	STCM-8
		CR-5B75-4I	60	34.9	350	69.9	TF8132I	SFM60	CLM12	STCM-8
		CR-8B75-4I	60	34.9	350	69.9	TF8132I	SFM60	CLM12	STCM-8
SI-CLHOR-50M9	970050M98	CR-8R-7I	50	28.6	400	57.2	TF3218	SFM48	CLM12	XNSM-0825
SI-CLHOR-60M9	970060M98	CR-5B75-5I	60	34.9	400	69.9	TF3218	SFM48	CLM12	XNSM-0825



CHASERS

COMBINATION BAR

CR Chaser style

Threading, Facing and Turning
ALL-IN-ONE

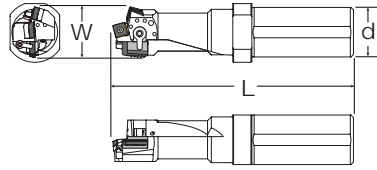

Description	EDP Code	W	d	L	Chaser	Turning Insert	Seat Screw	CHASER SPARE PARTS					TURNING SPARE PARTS			
								Seat	Side Clamp	Clamp Screw	Insert Clamp	Clamp Screw	Seat	Clamp	Clamp Screw	Lock Pin
SI-CLHORM-329	97103298	1.992	2.000	8.990	CR-8R-71*	SNMG-43_*	SF-48	TF3218	TC-191	XNS-35	TC-311	XNS-59	ISSN-433	CLM-7	XNS-35	NL-46
					CR-5B75-51*	SNMG-43_*	SF-48	TF3218	TC-191	XNS-35	TC-311	XNS-59	ISSN-433	CLM-7	XNS-35	NL-46
SI-CLHORM-40M9	9710M4098	1.992	40	250	CR-8R-71*	SNMG-43_*	SF-48	TF3218	TC-191	XNS-35	TC-311	XNS-59	ISSN-433	CLM-7	XNS-35	NL-46
					CR-5B75-51*	SNMG-43_*	SF-48	TF3218	TC-191	XNS-35	TC-311	XNS-59	ISSN-433	CLM-7	XNS-35	NL-46
SI-CLHORM-50M9	9710M5098	2.467	50	300	CR-8R-71*	SNMG-43_*	SF-48	TF3218	TC-191	XNS-35	TC-311	XNS-59	ISSN-433	CLM-7	XNS-35	NL-46
					CR-5B75-51*	SNMG-43_*	SF-48	TF3218	TC-191	XNS-35	TC-311	XNS-59	ISSN-433	CLM-7	XNS-35	NL-46
SI-CLHORM-60M9	9710M6098	3.146	60	350	CR-8R-71*	SNMG-64_*	SF-48	TF3218	TC-191	XNS-35	TC-311	XNS-59	ISSN-633	CLM-12	STCM-8	NL-68
					CR-5B75-51*	SNMG-64_*	SF-48	TF3218	TC-191	XNS-35	TC-311	XNS-59	ISSN-633	CLM-12	STCM-8	NL-68

*These items are sold separately.

CNGA Chaser style (Double sided)

Threading, Facing and Turning
ALL-IN-ONE

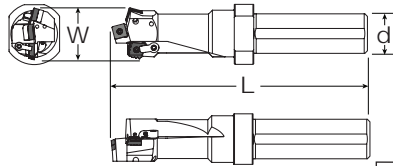

Description	EDP Code	W	d	L	Chaser	Turning Insert	TURNING SPARE PARTS				CHASER SPARE PARTS			
							Lock Pin	Seat	Clamp	Clamp Screw	Clamp	Clamp Screw	Lock Pin	
SI-PCLHORM-329	97153298	1.977	2.000	228.6	CNGA-8R-31*	SNMG-43_*	NL-46	ISSN-433	CLM-7	STCM-9	CLM-20	STCM-11	NL-44	
					CNGA-5B75-31*	SNMG-43_*	NL-46	ISSN-433	CLM-7	STCM-9	CLM-20	STCM-11	NL-44	
SI-PCLHORM-40M9	9715M4098	1.977	40	250	CNGA-8R-31*	SNMG-43_*	NL-46	ISSN-433	CLM-7	STCM-9	CLM-20	STCM-11	NL-44	
					CNGA-5B75-31*	SNMG-43_*	NL-46	ISSN-433	CLM-7	STCM-9	CLM-20	STCM-11	NL-44	
SI-PCLHORM-50M9	9715M5098	2.467	50	300	CNGA-8R-31*	SNMG-43_*	NL-46	ISSN-433	CLM-7	STCM-9	CLM-20	STCM-11	NL-44	
					CNGA-5B75-31*	SNMG-43_*	NL-46	ISSN-433	CLM-7	STCM-9	CLM-20	STCM-11	NL-44	
SI-PCLHORM-60M9	9715M6098	3.144	60	350	CNGA-8R-31*	SNMG-64_*	NL-68	ISSN-633	CLM-12	STCM-8	CLM-20	STCM-11	NL-44	
					CNGA-5B75-31*	SNMG-64_*	NL-68	ISSN-633	CLM-12	STCM-8	CLM-20	STCM-11	NL-44	

*These items are sold separately.

Technical Information

API ROUND THREADING		8 & 10 PITCH	
application		surface meters/minute (M/MIN)	
External		152.40 - 243.84	
Internal		152.40 - 213.36	

API BUTTRESS THREADING		5 PITCH	
application		surface meters/minute (M/MIN)	
External		91.44 - 152.40	
Internal		152.40 - 213.36	

- Number of passes is dictated by the number of teeth on the insert.
 - 3-4 tooth requires 3-5 passes
 - 7 tooth requires 1-2 passes
 - One or two additional passes may be required for heat treated materials.

internal chaser application

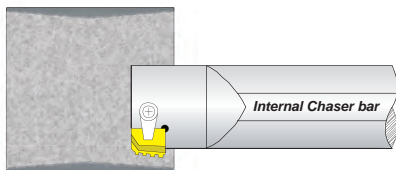

external chaser application

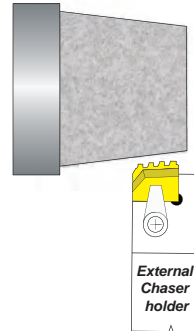



Technical Information

Recommended M/MIN for Chasers

EXTERNAL 8 Round Sets	1st Choice	2nd Choice	A/TIN PVD	CVD	General purpose
	A/TIN PVD	A/TIN PVD	A/TIN PVD	TIN PVD	TIN PVD
Material	ZA3	AC3	AC50	G50	GP50
H	152.40	152.40	152.40	152.40	243.84
J	152.40	152.40	152.40	152.40	243.84
K	152.40	152.40	152.40	152.40	243.84
L	152.40	152.40	152.40	152.40	182.88
N	152.40	152.40	152.40	152.40	182.88
P	152.40	152.40	152.40	152.40	182.88

ZA3 - All diameters
AC3 - All diameters
AC50 - All diameters
G50 - 4-1/2" - 9-5/8" Casing
GP50 - 2-3/8" - 3-1/2" Tubing

EXTERNAL 8 Round Stand Alone TF19310	1st Choice	2nd Choice	TIN PVD	TIN CVD
	A/TIN PVD	A/TIN PVD	TIN PVD	TIN CVD
Material	ZA3	AC3	AC50	G50
H	152.40	152.40	152.40	152.40
J	152.40	152.40	152.40	152.40
K	152.40	152.40	152.40	152.40
L	152.40	152.40	152.40	152.40
N	152.40	152.40	152.40	152.40
P	152.40	152.40	152.40	152.40

AC50 - 3-1/2" - 7" diameters
G50 - Only over 7" diameters
 4 PASSES

INTERNAL 8 Round Stand Alone TF19437 4 TOOTH	1st Choice	A/TIN PVD	A/TIN PVD
	A/TIN PVD	A/TIN PVD	A/TIN PVD
Material	ZA3	AC3	AC50
H	213.36	213.36	213.36
J	213.36	213.36	213.36
K	213.36	213.36	213.36
L	213.36	213.36	213.36
N	213.36	213.36	213.36
P	213.36	213.36	213.36

ZA3 - All diameters
AC3 - All diameters
AC50 - All diameters
 4-5 PASSES

INTERNAL 8 Round Stand Alone TF17968 7 TOOTH	1st Choice	2nd Choice	TIN PVD
	A/TIN PVD	A/TIN PVD	TIN PVD
Material	ZA3	AC3	AC50
H	152.40	152.40	213.36
J	152.40	152.40	213.36
K	152.40	152.40	213.36
L	152.40	152.40	213.36
N	152.40	152.40	213.36
P	152.40	152.40	213.36

AC50 - All diameters
 1-2 PASSES

EXTERNAL Buttress Sets	1st Choice	TIN CVD
	A/TIN PVD	TIN CVD
Material	ZA3	G50
H		152.40
J		152.40
K		152.40
L		152.40
N		152.40
P		152.40

G50 - All diameters

EXTERNAL Buttress Stand Alone TF22675 3/4" TAPER	1st Choice	TIN CVD
	A/TIN PVD	TIN CVD
Material	ZA3	G50
H		243.84
J		243.84
K		243.84
L		182.88
N		182.88
P		182.88

G50 - All diameters
 5 PASSES

EXTERNAL Buttress Stand Alone TF1130 1" TAPER	1st Choice	TIN CVD
	A/TIN PVD	TIN CVD
Material	ZA3	G50
H		243.84
J		243.84
K		243.84
L		182.88
N		182.88
P		182.88

G50 - All diameters
 5 PASSES

INTERNAL Buttress Stand Alone TF22675 3/4" TAPER	1st Choice	TIN CVD
	A/TIN PVD	TIN CVD
Material	ZA3	G50
H		243.84
J		243.84
K		243.84
L		182.88
N		182.88
P		182.88

G50 - All diameters
 5 PASSES

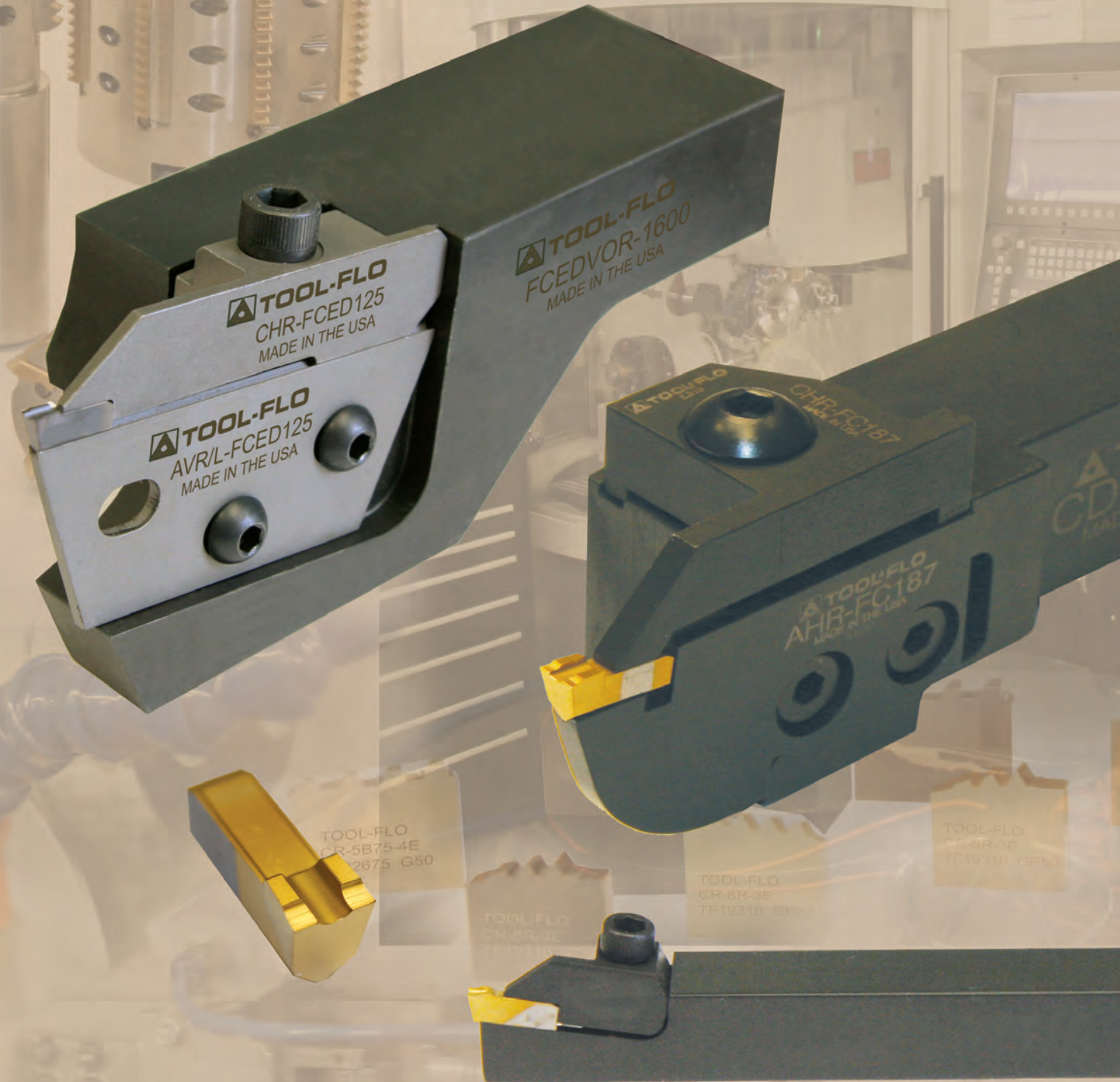

CUT OFF

FC SERIES CUT OFF



INSERT FC

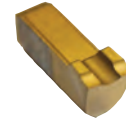
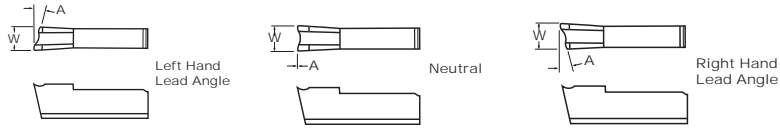

Uncoated	TiN Coated	AlTiN Coated	
C36	GP26	GP530	AC26
			AC3
			AC550

■ Toolholders listed below

Description	EDP Code	Competitor Nomenclature	Insert Width	A	Hand	C36	GP26	GP530	AC26	AC3	AC550
FC-094-N	FC094N	507-140	.094 (2.39)	0°	N	●	●	●	●	●	●
FC-094-L-4	FC094L4	507-144	.094 (2.39)	4°	L	●	●	●	●	●	●
FC-094-L-12	FC094L12	507-152	.094 (2.39)	12°	L	●	●	●	●	●	●
FC-094-R-4	FC094R4	507-143	.094 (2.39)	4°	R	●	●	●	●	●	●
FC-094-R-12	FC094R12	507-151	.094 (2.39)	12°	R	●	●	●	●	●	●
FC-094-R-18	FC094R18	507-161	.094 (2.39)	18°	R	●	●	●	●	●	●
FC-125-N	FC125N	507-117	.125 (3.18)	0°	N	●	●	●	●	●	●
FC-125-L-4	FC125L4	507-129	.125 (3.18)	4°	L	●	●	●	●	●	●
FC-125-L-12	FC125L12	507-154	.125 (3.18)	12°	L	●	●	●	●	●	●
FC-125-R-4	FC125R4	507-128	.125 (3.18)	4°	R	●	●	●	●	●	●
FC-125-R-12	FC125R12	507-146	.125 (3.18)	12°	R	●	●	●	●	●	●
FC-125-R-18	FC125R18	507-155	.125 (3.18)	18°	R	●	●	●	●	●	●
FC-187-N	FC187N	507-116	.187 (4.75)	0°	N	●	●	●	●	●	●
FC-187-L-4	FC187L4	507-125/507-127	.187 (4.75)	4°	L	●	●	●	●	●	●
FC-187-R-4	FC187R4	507-124/507-126	.187 (4.75)	4°	R	●	●	●	●	●	●
FC-187-R-12	FC187R12	507-176	.187 (4.75)	12°	R	●	●	●	●	●	●

In an effort to improve our stock standard grade offering, there are periodic changes. Please see current price list for up-to-date grade offering.

- High performance choice in optimal conditions.
- ▲ Recommended grade under general conditions.

COMPETITOR'S GRADES	M40	M50	M43
Steel (Low to moderate speeds)	●		
Steel (Moderate to high speeds)			●
Stainless (Low to moderate speeds)		●	
Stainless (Moderate to high speeds)			●

FC SERIES

HOLDERS FCIVOR 1/2"

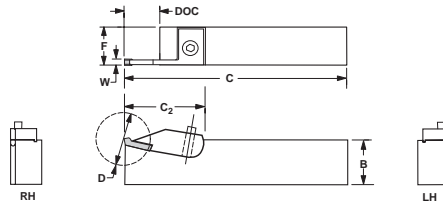

Description	EDP Code	Competitor Part No.	Max Dia. D	B	C	C2	F	Clamp Screw	CLAMP Description	D.O.C.	EDP Code	Competitor Part No.
FCIVOR-12M-2.38	9FCIR12M238	206-175	27.00	12.70	152.00	25.40	12.70	SSM65	CHR-FCI094	13.49	9HCHRFCI094	435-152
FCIVOR-12M-3.18	9FCIR12M318	206-145	27.00	12.70	152.00	25.40	12.70	SSM65	CHR-FCI125	13.49	9HCHRFCI125	435-130

HOLDERS FCVOR/L 1/2" & 3/4"

■ RH holders use RH components

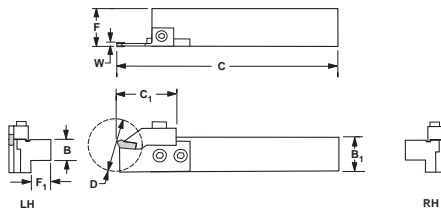

Description	EDP Code	Competitor Nomenclature	D-Max	B	B1	C	C1	F	F1	Anvil Screw	Clamp Screw
FCVOR-080B	9FCR0800	206-179	41.28	12.70	19.05	114.30	35.05	25.40	11.68	SS84M	SSM91
FCVOL-080B	9FCL0800	206-180	41.28	12.70	19.05	114.30	35.05	25.40	11.68	SS84M	SSM91
FCVOR/L-1200B	9FCR/L1200	206-178	41.28	19.05	19.05	114.30	35.05	25.40	11.68	SS84M	SSM91

COMPONENT PARTS AVR-FCS Anvils



Description	EDP Code	Competitor Part No.	Width	D.O.C.
AVR-FCS094	911FC094	333-101	2.38	20.62
AVR-FCS125	911FC125	333-102	3.18	20.62
AVL-FCS094	910FC094	333-103	2.38	20.62
AVL-FCS125	910FC125	333-104	3.18	20.62

COMPONENT PARTS CHR-FCS Clamps

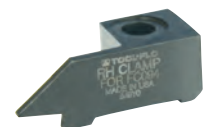

Description	EDP Code	Competitor Part No.	Width	D.O.C.
CHR-FCS094	9H1FCR094	435-154	2.38	20.62
CHR-FCS125	9H1FCR125	435-155	3.18	20.62
CHL-FCS094	9H1FCL094	435-156	2.38	20.62
CHL-FCS125	9H1FCL125	435-157	3.18	20.62



FC SERIES CUT OFF

HOLDERS

FCVOR/L

1" & 1-1/4"

■ RH holders use RH components

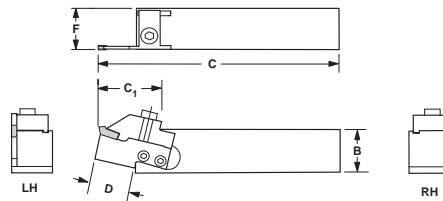

Description	EDP Code	Competitor Nomenclature	D	B	C	C ₁	F	Anvil Screw	Clamp Screw
FCVOR-1600D	9FCR1600D	206-141	20.62	25.40	152.40	38.10	31.75	SS82M	SSM83
FCVOL-1600D	9FCL1600D	206-142	20.62	25.40	152.40	38.10	31.75	SS82M	SSM83
FCVOR-2000D	9FCR2000D	206-143	20.62	31.75	152.40	38.10	38.10	SS82M	SSM83
FCVOL-2000D	9FCL2000D	206-144	20.62	31.75	152.40	38.10	38.10	SS82M	SSM83

COMPONENT PARTS

AVR-FCL Anvils



Description	EDP Code	Competitor Part No.	Width	D.O.C.
AVR-FCL094	901FC094	331-117	2.38	12.70
AVR-FCL125	901FC125	331-101	3.18	20.32
AVR-FCL187	901FC187	331-103	4.76	20.32
AVL-FCL094	900FC094	331-118	2.38	12.70
AVL-FCL125	900FC125	331-102	3.18	20.32
AVL-FCL187	900FC187	331-104	4.76	20.32

COMPONENT PARTS

CHR-FCL Clamps



Description	EDP Code	Competitor Part No.	Width	D.O.C.
CHR-FCL094	9H0FCR094	435-142	2.38	12.70
CHR-FCL125/187	9H0FCR125/187	435-128	3.18 & 4.76	20.32
CHL-FCL094	9H0FCL094	435-143	2.38	12.70
CHL-FCL125/187	9H0FCL125/187	435-129	3.18 & 4.76	20.32

FC SERIES

HOLDERS

CDVOR/L

1", 1-1/4", 1-1/2"

■ RH holders use RH components

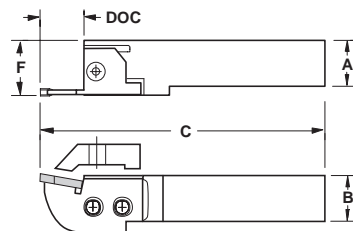

Description	EDP Code	Insert Width	A	B	C	F	Clamp Screw	Anvil Screw
CDVOR-25M	92412500	27.00	25.00	25.00	*	31.39	SBM90	SFM95
CDVOL-25M	92312500	27.00	25.00	25.00	*	31.39	SBM90	SFM95
CDVOR-32M	92413200	27.00	32.00	32.00	*	44.30	SBM90	SFM95
CDVOL-40M	92414000	27.00	40.00	40.00	*	44.30	SBM90	SFM95

*Determined by the anvil

COMPONENT PARTS

AHR-FC Anvils



Description	EDP Code	D.O.C.
AHR-FC094	9150FC094	12.70
AHR-FC125	9150FC125	25.40
AHR-FC187	9150FC187	25.40
AHL-FC094	9151FC094	12.70
AHL-FC125	9151FC125	25.40
AHL-FC187	9151FC187	25.40

COMPONENT PARTS

CHR-FC Clamps

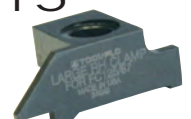

Description	EDP Code	D.O.C.
CHR-FC094	9HCHRFC094	12.70
CHR-FC125	9HCHRFC125	25.40
CHR-FC187	9HCHRFC187	25.40
CHL-FC094	9HCHLFC094	12.70
CHL-FC125	9HCHLFC125	25.40
CHL-FC187	9HCHLFC187	25.40

HOLDERS

FCEDVOR

1", 1-1/4"

■ RH holders use RH components listed on following page.

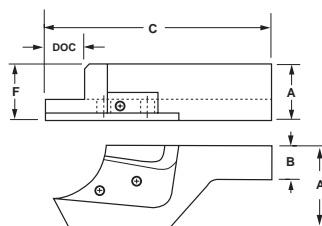

Description	EDP Code	Competitor Nomenclature	DOC	A	A ₁	B	F	C	Anvil Screw	Clamp Screw
FCEDVOR-1600D	9FCEDR1600D	206-116	38.10	44.93	56.49	25.40	44.70	152.40	SM-352	SBM-628
FCEDVOL-1600D	9FCEDL1600D	206-119	38.10	44.93	56.49	25.40	44.70	152.40	SM-352	SBM-628
FCEDVOR-2000D	9FCEDR2000D	206-121	38.10	48.23	56.49	31.75	48.01	152.40	SM-352	SBM-628
FCEDVOL-2000D	9FCEDL2000D	206-124	38.10	48.23	56.49	31.75	48.01	152.40	SM-352	SBM-628



COMPONENT PARTS

AVR/L-FCED Anvils

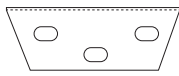
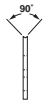

Description	EDP Code	D.O.C.
AVR/L-FCED125	902FCED125	38.10
AVR/L-FCED187	902FCED187	38.10

COMPONENT PARTS

CHR/L-FCED Clamps

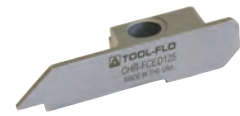
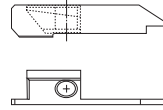

Description	EDP Code	D.O.C.
CHR-FCED125	9H2FCEDR125	38.10
CHL-FCED125	9H2FCEDL125	38.10
CHR-FCED187	9H2FCEDR187	38.10
CHL-FCED187	9H2FCEDL187	38.10

FC SERIES

Recommended M/MIN & M/REV for Parting Applications

Workpiece Group	Uncoated	TiN PVD		AlTiN PVD		MM/REV
	C22	GP22	GP50	AC22	AC50	
Free Machining Carbon Steels	---	45.72 - 91.44	60.96 - 182.88	60.96 - 121.92	121.92 - 243.84	0.076-0.203
Plain Carbon Steels	---	45.72 - 91.44	60.96 - 182.88	60.96 - 121.92	121.92 - 243.84	0.076-0.203
Alloy Steels 190-330 HB	---	45.72 - 91.44	60.96 - 152.40	60.96 - 106.68	121.92 - 243.84	0.076-0.203
Alloy Steels 330-450 HB	---	45.72 - 91.44	60.96 - 137.16	60.96 - 106.68	121.92 - 228.60	0.076-0.203
Martensitic/Ferritic Stainless Steel 400 Series	---	45.72 - 91.44	60.96 - 152.40	60.96 - 121.92	106.68 - 213.36	0.076-0.203
Austenitic Stainless 300 Series	45.72 - 91.44	45.72 - 121.92	---	91.44 - 182.88	---	0.508-0.178
Gray Cast Iron 190-330 HB	30.48 - 106.68	45.72 - 121.92	---	91.44 - 182.88	---	0.508-0.178
Gray Cast Iron 330-450 HB	30.48 - 91.44	45.72 - 106.68	---	60.96 - 167.64	---	0.508-0.178
Alloy / Ductile Irons	---	45.72 - 91.44	60.96 - 152.40	76.20 - 137.16	91.44 - 213.36	0.076-0.203
Free Machining Aluminum Alloys	30.48 - 457.20	45.72 - 609.60	---	182.88 - 670.56	---	0.102-0.203
High-Silicon Aluminum Alloys	---	---	---	---	---	---
Copper / Zinc / Brass	30.48 - 154.00	45.72 - 213.36	---	91.44 - 274.32	---	0.102-0.203
Non-Metallics	30.48 - 304.80	45.72 - 457.20	---	106.68 - 365.76	---	0.102-0.203
High Temperature Alloys 200-260 HB	24.38 - 39.62	30.48 - 53.34	---	24.38 - 60.96	---	0.051-0.152
High Temperature Alloys 260-450 HB	15.24 - 30.48	24.38 - 45.72	---	24.38 - 53.34	---	0.051-0.152
Titanium Alloys (Ti 6Al-4V)	30.48 - 60.96	30.48 - 76.20	---	24.38 - 91.44	---	0.051-0.152

Bold print items denote the top choices for the materials listed, provided it can be machined within the M/MIN stated under the appropriate machining conditions. For the best performance in optimal machining conditions, select the grade that will provide you with the highest allowable M/MIN.

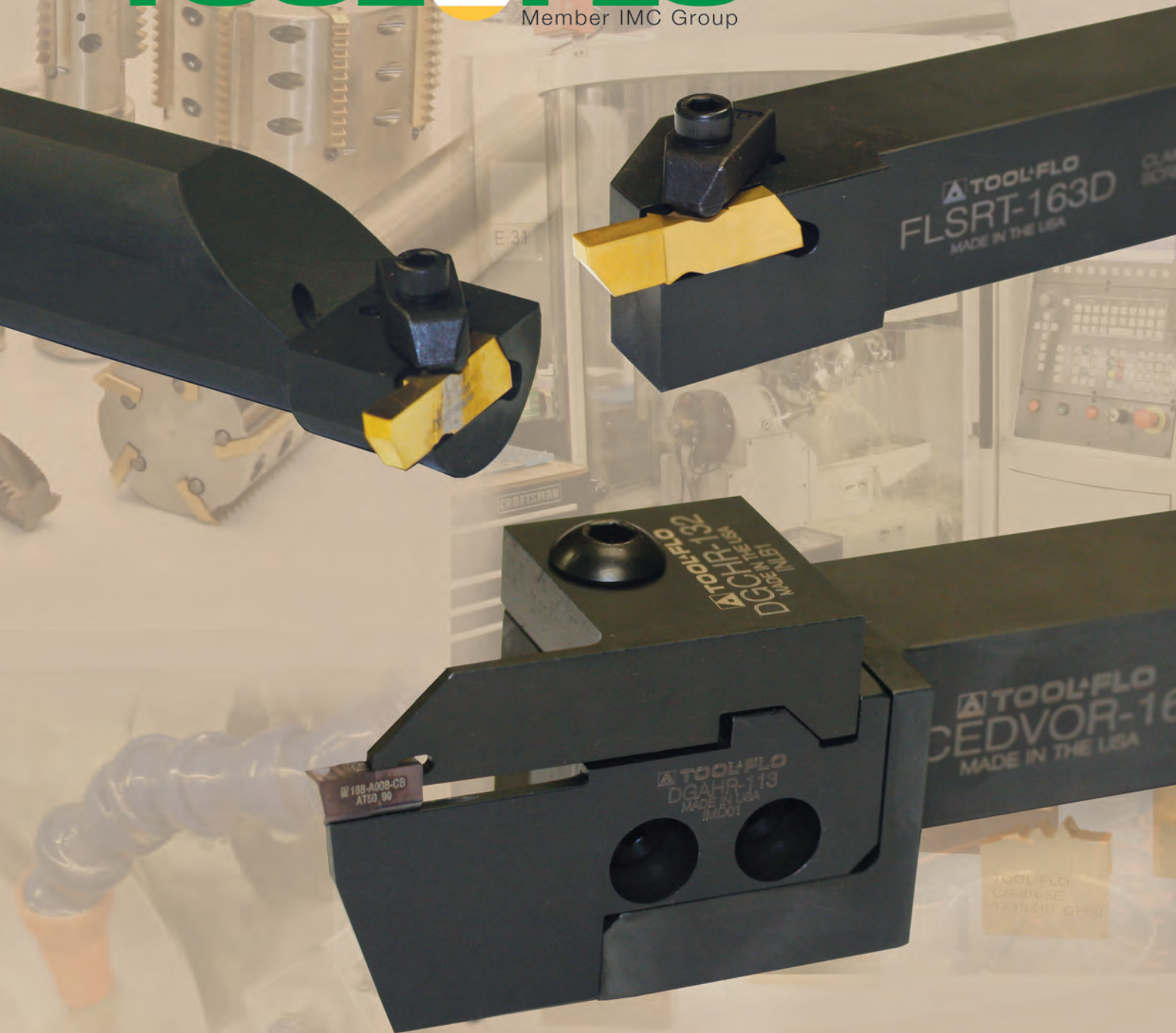

**DEEP
GROOVING**



Deep Grooving Insert Nomenclature Chart

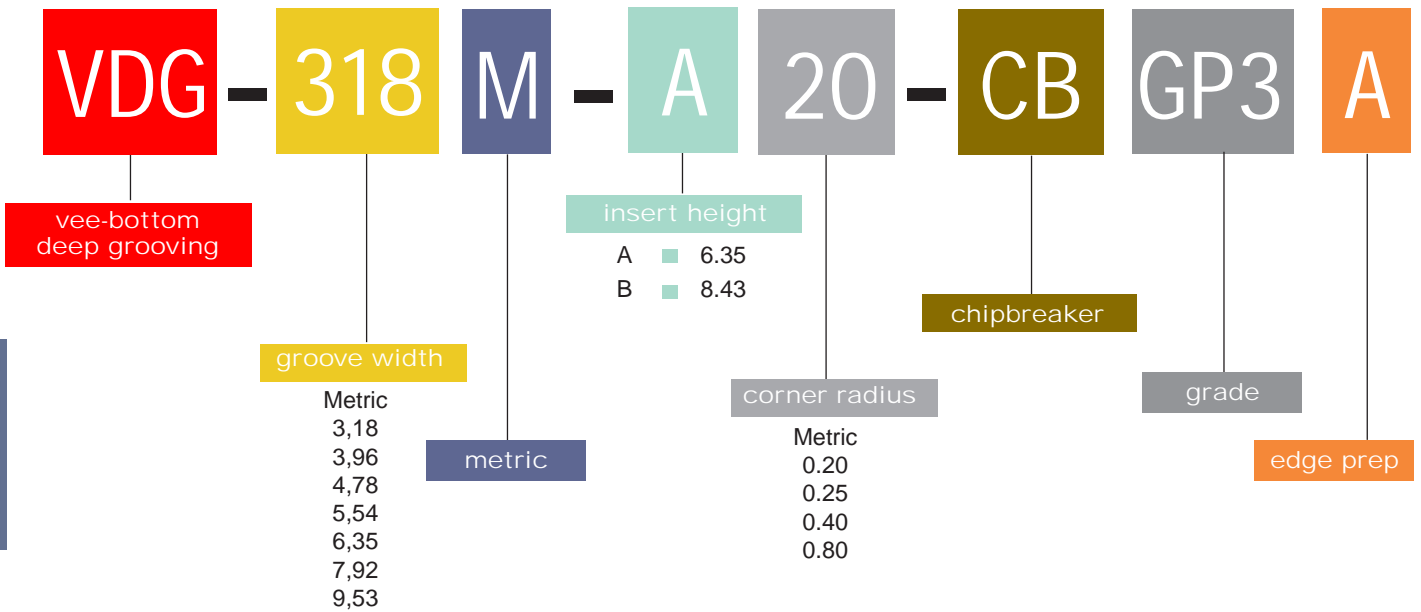

DEEP GROOVING VDG

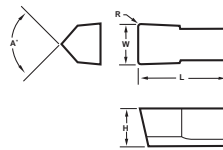

Description	EDP Code	W	R	L	H	A	Uncoated		TIN Coated		AlTiN Coated	
							C3	C6H	GP3	GP50	AC3	AC50
VDG-3M-A02	823M02	3.00 (.118)	0.2 (.008)	12.7	6.35	90°			●	●	●	●
VDG-3M-A04	823M04	3.00 (.118)	0.4 (.016)	12.7	6.35	90°			●	●	●	●
VDG-4M-A02	824M02	4.00 (.157)	0.2 (.008)	12.7	6.35	90°			●	●	●	●
VDG-4M-A04	824M04	4.00 (.157)	0.4 (.016)	12.7	6.35	90°			●	●	●	●
VDG-5M-A02	825M02	5.00 (.197)	0.2 (.008)	12.7	6.35	90°			●	●	●	●
VDG-5M-A04	825M04	5.00 (.197)	0.4 (.016)	12.7	6.35	90°			●	●	●	●
VDG-6M-B04	826M04	6.00 (.236)	0.4 (.016)	12.7	8.55	90°			●	●	●	●
VDG-6M-B08	826M08	6.00 (.236)	0.8 (.031)	12.7	8.55	90°			●	●	●	●
VDG-8M-B04	828M04	8.00 (.315)	0.4 (.016)	12.7	8.55	90°			●	●	●	●
VDG-8M-B08	828M08	8.00 (.315)	0.8 (.031)	12.7	8.55	90°			●	●	●	●

DEEP GROOVING VDG-CB

w/patented chipbreaker

Exclusive patented design!

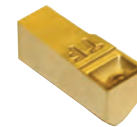
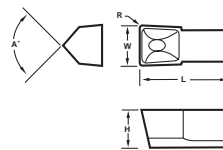

Description	EDP Code	W	R	L	H	A	Uncoated		TIN Coated		AlTiN Coated	
							C3	C6H	GP3	GP50	AC3	AC50
VDG-3M-A02-CB	823M02C	3.00 (.118)	0.2 (.008)	12.7	6.35	90°			●	●	●	●
VDG-3M-A04-CB	823M04C	3.00 (.118)	0.4 (.016)	12.7	6.35	90°			●	●	●	●
VDG-4M-A02-CB	824M02C	4.00 (.157)	0.2 (.008)	12.7	6.35	90°			●	●	●	●
VDG-4M-A04-CB	824M04C	4.00 (.157)	0.4 (.016)	12.7	6.35	90°			●	●	●	●
VDG-5M-A02-CB	825M02C	5.00 (.197)	0.2 (.008)	12.7	6.35	90°			●	●	●	●
VDG-5M-A04-CB	825M04C	5.00 (.197)	0.4 (.016)	12.7	6.35	90°			●	●	●	●
VDG-6M-B04-CB	826M04C	6.00 (.236)	0.4 (.016)	12.7	8.55	90°			●	●	●	●
VDG-6M-B08-CB	826M08C	6.00 (.236)	0.8 (.016)	12.7	8.55	90°			●	●	●	●
VDG-8M-B04-CB	828M04C	8.00 (.315)	0.4 (.016)	12.7	8.55	90°			●	●	●	●
VDG-8M-B08-CB	828M08C	8.00 (.315)	0.8 (.016)	12.7	8.55	90°			●	●	●	●

In an effort to improve our stock standard grade offering, there are periodic changes. Please see current price list for up-to-date grade offering.

● High performance choice in optimal conditions.
▲ Recommended grade under general conditions.

	C3	C6H	GP3	GP50	AC3	AC50
Cast Iron			▲	●		
Non-Ferrous			●	▲		
Stainless/High Temp			▲	●		
Steel				▲		●



DEEP GROOVING

EXTERNAL STRAIGHT HOLDER CEDVOR/L

RH holders use RH components

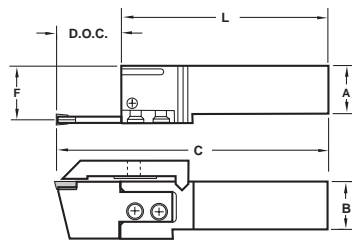

RH SHOWN



Description	EDP Code	A	B	L	F	Clamp Screw	Anvil Screw
CEDVOR-25M	91962500	25,0	25,0	132,0	28,5	SBM90	SFM90
CEDVOL-25M	91912500	25,0	25,0	132,0	28,5	SBM90	SFM90
CEDVOR-32M	91963200	32,0	32,0	132,0	28,5	SBM90	SFM90
CEDVOL-32M	91913200	32,0	32,0	132,0	28,5	SBM90	SFM90
CEDVOR-40M	91964000	40,0	40,0	132,0	36,0	SBM90	SFM90
CEDVOL-40M	91914000	40,0	40,0	132,0	36,0	SBM90	SFM90

*The "C" dimension is determined by the D.O.C. of the anvil.

DEEP GROOVING

COMPONENTS DGAHR/L

Anvils for CEDVOR/L

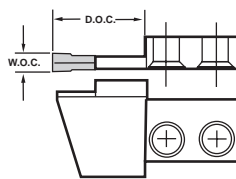

RH SHOWN

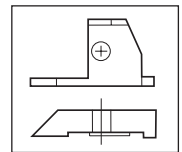

Description	EDP Code	Insert	DOC	WOC	Clamp
DGAHR-113	9263113	VDG	31.75	76.20 (3.00)	DGCHR-132
DGAHL-113	9262113	VDG	31.75	76.20 (3.00)	DGCHL-132
DGAHR-138	9263138	VDG	34.93	101.60 (4.00)	DGCHR-382
DGAHL-138	9262138	VDG	34.93	101.60 (4.00)	DGCHL-382
DGAHR-248	9263248	VDG	38.10	127.00 (5.00)	DGCHR-482
DGAHL-248	9262248	VDG	38.10	127.00 (5.00)	DGCHL-482
DGAHR-258	9263258	VDG	38.10	152.40 (6.00)	DGCHR-500
DGAHL-258	9262258	VDG	38.10	152.40 (6.00)	DGCHL-500
DGAHR-268M	9263268M	VDG	44.45	203.20 (8.00)	DGCHR-582M
DGAHL-268M	9262268M	VDG	44.45	203.20 (8.00)	DGCHL-582M

DEEP GROOVING FLGT

Double ended

Exclusive TOOL-FLO design!

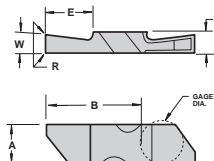

Description	EDP Code	W	R	T	E	A	B	Gage Dia	Coating					
									C3	C6H	GP3	GP50	AC3	AC50
FLGT-330R	633230R	3.00 (.118)	0.13/0.25	4.95	6.99	8.74	21.72	9.53			●	●	●	●
FLGT-330L	633230L	3.00 (.118)	0.13/0.25	4.95	6.99	8.74	21.72	9.53			●	●	●	●
FLGT-340R	633240R	4.00 (.157)	0.13/0.25	4.95	11.10	8.74	21.72	9.53			●	●	●	●
FLGT-340L	633240L	4.00 (.157)	0.13/0.25	4.95	11.10	8.74	21.72	9.53			●	●	●	●
FLGT-450R	6344250R	5.00 (.197)	0.51/0.64	6.48	13.97	11.51	28.85	9.53		●	●	●	●	●
FLGT-450L	6344250L	5.00 (.197)	0.51/0.64	6.48	13.97	11.51	28.85	9.53		●	●	●	●	●
FLGT-460R	6344260R	6.00 (.236)	0.51/0.64	6.48	13.97	11.51	28.85	9.53			●	●	●	●
FLGT-460L	6344260L	6.00 (.236)	0.51/0.64	6.48	13.97	11.51	28.85	9.53			●	●	●	●



FLRT

Full Nose Radius - Double ended

Exclusive TOOL-FLO design!

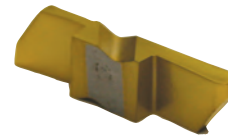
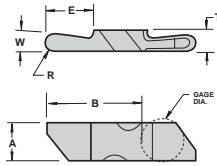

Description	EDP Code	W	R	T	E	A	B	Gage Dia	Uncoated		TiN Coated		AlTiN Coated	
									C3	C6H	GP3	GP50	AC3	AC50
FLRT-330R	6337062R	3.30 (.130)	1.57 (.065)	4.95	11.10	8.74	21.72	9.53						
FLRT-330L	6337062L	3.30 (.130)	1.57 (.065)	4.95	11.10	8.74	21.72	9.53						
FLRT-350R	6337094R	5.00 (.197)	2.39 (.098)	4.95	11.10	8.74	21.72	9.53						
FLRT-350L	6337094L	5.00 (.197)	2.39 (.098)	4.95	11.10	8.74	21.72	9.53						
FLRT-4330R	6347062R	3.30 (.130)	1.57 (.065)	6.48	13.97	11.51	28.85	9.53						
FLRT-4330L	6347062L	3.30 (.130)	1.57 (.065)	6.48	13.97	11.51	28.85	9.53						
FLRT-450R	6347094R	5.00 (.197)	2.39 (.098)	6.48	13.97	11.51	28.85	9.53						
FLRT-450L	6347094L	5.00 (.197)	2.39 (.098)	6.48	13.97	11.51	28.85	9.53						

In an effort to improve our stock standard grade offering, there are periodic changes. Please see current price list for up to date grade offering.

- High performance choice in optimal conditions.
- ▲ Recommended grade under general conditions.

Cast Iron			▲	●	
Non-Ferrous	●		▲		
Stainless/High Temp		▲	●		
Steel			▲	●	

DEEP GROOVING

EXTERNAL HOLDER

FLSR/LT

For double ended FLGT/FLRT inserts

Inch

Exclusive TOOL-FLO design!

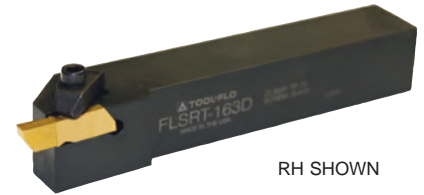
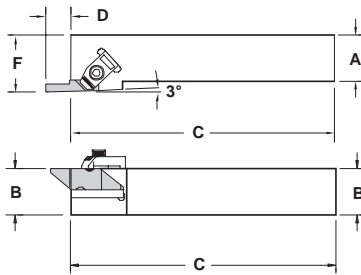

RH SHOWN

See page 60 for coolant fed clamps

Description	EDP Code	Insert	A	B	C	D	F	Clamp	Clamp Screw
FLSRT-2525M3	934325M16	FL_T-3R	25.0	25.0	152.4	11.2	32.0	TF-72	SSM-51
FLSLT-2525M3	934225M16	FL_T-3L	25.0	25.0	152.4	11.2	32.0	TF-73	SSM-51
FLSRT-3232M3	934332M16	FL_T-3R	32.0	32.0	152.4	11.2	40.0	TF-72	SSM-51
FLSLT-3232M3	934232M16	FL_T-3L	32.0	32.0	152.4	11.2	40.0	TF-73	SSM-51
FLSRT-2525M4	934325M20	FL_T-4R	25.0	25.0	152.4	14.2	32.0	TF-72	SSM-51
FLSLT-2525M4	934225M20	FL_T-4L	25.0	25.0	152.4	14.2	32.0	TF-73	SSM-51
FLSRT-3232M4	934332M20	FL_T-4R	32.0	32.0	152.4	14.2	40.0	TF-72	SSM-51
FLSLT-3232M4	934232M20	FL_T-4L	32.0	32.0	152.4	14.2	40.0	TF-73	SSM-51

FLER/LT

For double ended FLGT/FLRT inserts

Exclusive TOOL-FLO design!

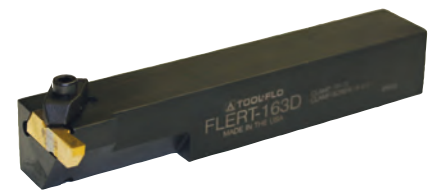
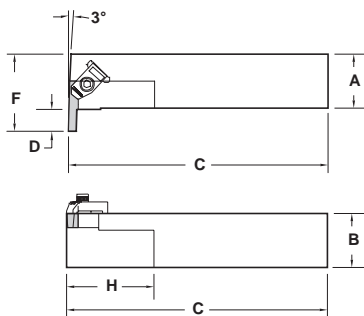

RH SHOWN

See page 60 for coolant fed clamps

Description	EDP Code	Insert	A	B	C	D	F	Clamp	Clamp Screw
FLERT-2525M3	931125M16	FL_T-3L	25.00	25.00	152.00	11.18	31.75	TF-72	SSM-51
FLELT-2525M3	930125M16	FL_T-3R	25.00	25.00	152.00	11.18	31.75	TF-73	SSM-51
FLERT-3232M3	931132M16	FL_T-3L	32.00	32.00	152.00	11.18	38.10	TF-72	SSM-51
FLELT-3232M3	930132M16	FL_T-3R	32.00	32.00	152.00	11.18	38.10	TF-73	SSM-51
FLERT-2525M4D	931125M20	FL_T-4L	25.00	25.00	152.00	14.22	31.75	TF-72	SSM-51
FLELT-2525M4D	930125M20	FL_T-4R	25.00	25.00	152.00	14.22	31.75	TF-73	SSM-51
FLERT-3232M4D	931132M20	FL_T-4L	32.00	32.00	152.00	14.22	38.10	TF-72	SSM-51
FLELT-3232M4D	930132M20	FL_T-4R	32.00	32.00	152.00	14.22	38.10	TF-73	SSM-51



DEEP GROOVING

INTERNAL BAR

A_FLER/LT

For double ended FLGT/FLRT inserts
Inch

Exclusive TOOL-FLO design!

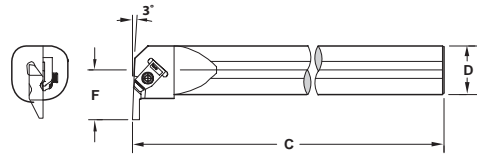

Description	EDP Code	Insert	D	C	F	Min. Bore	Clamp	Clamp Screw
A32M-FLERT3	96442016	FL_T-3L	32.0	350.0	27.48	46.00	TF-73	SSM-51
A32M-FLELT3	96432016	FL_T-3R	32.0	350.0	27.48	46.00	TF-72	SSM-51
A40M-FLERT3	96442416	FL_T-3L	40.0	350.0	31.60	54.15	TF-73	SSM-51
A40M-FLELT3	96432416	FL_T-3R	40.0	350.0	31.60	54.15	TF-72	SSM-51
A50M-FLERT4	96442820	FL_T-4L	50.0	350.0	40.87	68.43	TF-73	SSM-51
A50M-FLELT4	96432820	FL_T-4R	50.0	350.0	40.87	68.43	TF-72	SSM-51

DEEP GROOVING

Recommended M/MIN & MM/REV for Deep Grooving Applications

Workpiece Group	Uncoated	TiN PVD		AlTiN PVD		MM/REV	
	C3	GP3	GP50	AC3	AC50	Neutral Rake	Chipbreaker
	Free Machining Carbon Steels	---	60.96 - 121.92	60.96 - 182.88	76.20 - 137.16	121.92 - 243.84	.102 - .254
Plain Carbon Steels	---	60.96 - 121.92	60.96 - 182.88	76.20 - 137.16	121.92 - 243.84	.102 - .254	.127 - .356
Alloy Steels 190-330 HB	---	60.96 - 121.92	60.96 - 152.40	76.20 - 121.92	121.92 - 243.84	.102 - .254	.127 - .356
Alloy Steels 330-450 HB	---	60.96 - 106.68	60.96 - 137.16	76.20 - 121.92	121.92 - 228.60	.076 - .229	.127 - .305
Martensitic/Ferritic Stainless Steel 400 Series	---	60.96 - 121.92	60.96 - 152.40	76.20 - 137.16	106.68 - 215.60	.102 - .254	.127 - .356
Austenitic Stainless 300 Series	60.96 - 91.44	60.96 - 152.40	---	76.20 - 215.60	---	.076 - .229	.012 - .203
Gray Cast Iron 190-330 HB	30.48 - 91.44	60.96 - 182.88	---	76.20 - 215.60	---	.102 - .254	---
Gray Cast Iron 330-450 HB	30.48 - 76.20	60.96 - 152.40	---	60.96 - 182.88	---	.076 - .229	---
Alloy / Ductile Irons	30.48 - 76.20	60.96 - 121.92	60.96 - 152.40	60.96 - 137.16	91.44 - 215.60	.102 - .254	.127 - .356
Free Machining Aluminum Alloys	152.40 - 457.20	91.44 - 609.60	---	182.88 - 762.00	---	.127 - .305	.203 - .406
High-Silicon Aluminum Alloys	---	---	---	---	---	---	---
Copper / Zinc / Brass	60.96 - 215.60	60.96 - 274.32	---	121.92 - 304.80	---	.127 - .305	.178 - .406
Non-Metallics	121.92 - 426.72	91.44 - 457.20	---	121.92 - 457.20	---	.127 - .305	---
High Temperature Alloys 200-260 HB	24.38 - 39.62	30.48 - 60.96	---	30.48 - 76.20	---	.076 - .152	.102 - .178
High Temperature Alloys 260-450 HB	15.24 - 30.48	30.48 - 53.34	---	30.48 - 60.96	---	.076 - .152	.102 - .178
Titanium Alloys (Ti 6Al-4V)	30.48 - 60.96	45.72 - 91.44	---	30.48 - 91.44	---	.076 - .152	.102 - .203

Bold print items denote the top choices for the materials listed, provided it can be machined within the M/MIN stated under the appropriate machining conditions. For the best performance in optimal machining conditions, select the grade that will provide you with the highest allowable M/MIN.



Grooving Limits (Maximum Internal Groove Depth vs Minimum Bore Diameter)

internal grooving limitations FLG-# 2, 3, 4, 5 & 6 Inserts		
Insert	maximum groove depth (mm)	minimum bore diameter (mm)
FLG-2031R/L	1.27	18.54
FLG-2041R/L	1.27	18.54
FLG-2047R/L	1.27	18.54
FLG-2058R/L	1.27	18.54
FLG-2062R/L	2.59	44.45
FLG-2094R/L	2.49	38.10
FLG-2125R/L	2.03	25.40
FLG-3047R/L	2.39	44.45
FLG-3062R/L	2.39	44.45
FLG-3072R/L	2.29	41.28
FLG-3078R/L	1.91	34.93
FLG-3088R/L	1.91	34.93
FLG-3094R/L	3.81	60.33
FLG-3097R/L	3.81	60.33
FLG-3105R/L	3.81	60.33
FLG-3110R/L	3.68	53.98
FLG-3122R/L	3.68	53.98
FLG-3125R/L	3.51	47.63
FLG-3142R/L	3.51	47.63
FLG-3156R/L	3.18	41.28
FLG-3178R/L	3.18	41.28
FLG-3185R/L	2.79	34.93
FLG-3189R/L	2.79	34.93
FLG-4125R/L	3.81	69.85
FLG-4189R/L	6.22	127.00
FLG-4213R/L	6.10	114.30
FLG-4219R/L	5.54	82.55
FLG-4250R/L	5.08	63.50
FLG-5250R/L	9.17	15.81
FLG-5281R/L	8.74	10.81
FLG-5312R/L	8.31	18.54
FLG-5344R/L	7.47	18.54
FLG-5375R/L	6.53	44.45
FLG-6250R/L	6.35	38.10
FLG-6281R/L	6.22	25.40
FLG-6312R/L	6.10	38.10
FLG-6344R/L	5.54	38.10
FLG-6375R/L	5.08	41.28

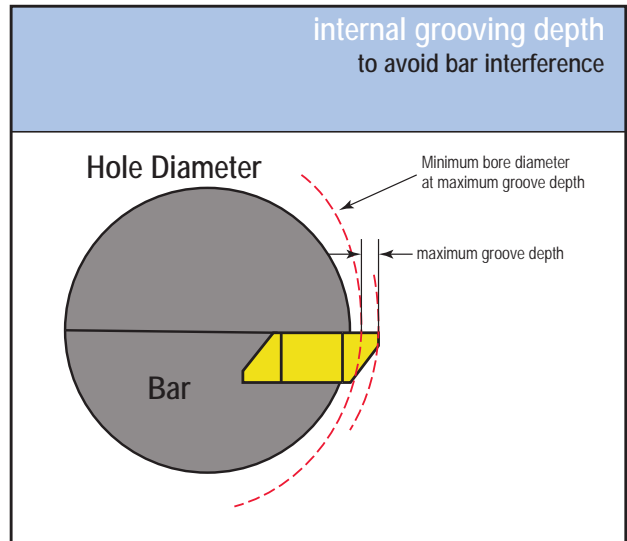

NOTE: Internal grooving depth limits are a function of bar clearance versus bore diameter.

*The same maximum groove depth and minimum bore diameter values also apply to the FLG-CB and FLR (Full radius) inserts of the same size and groove width.

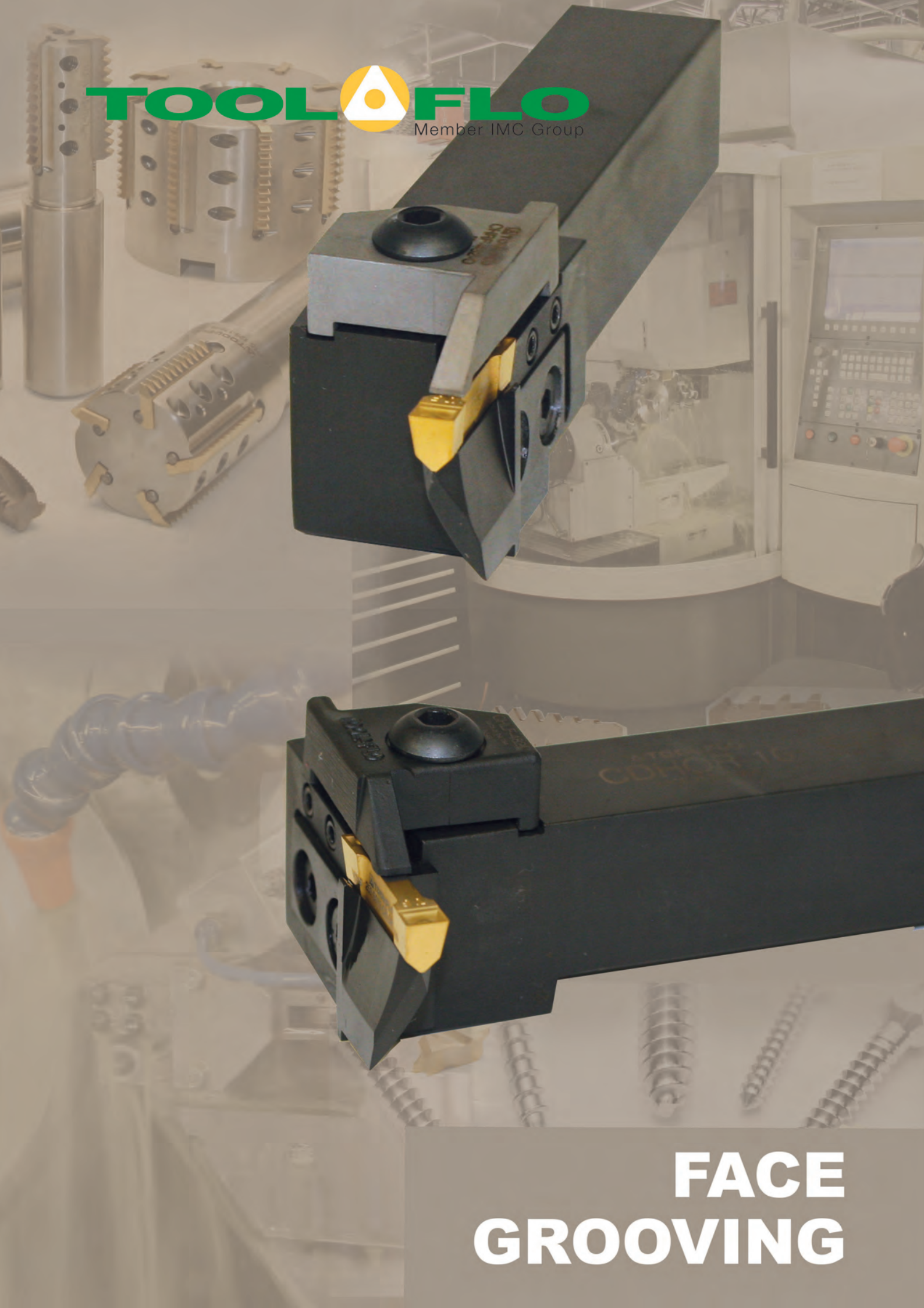

FACE GROOVING

FACE GROOVING



FACE GROOVING

FLF-CB

w/Patented chipbreaker

- Features: *Exclusive patented design!*
- Patented chipbreaker - Patent No. 6,146,064
 - Maximum chip control
 - Industry standard widths

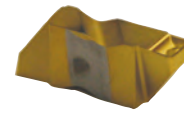
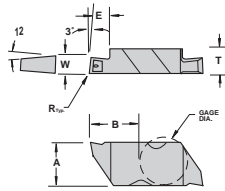

Description	EDP Code	W	R	E	T	A	B	Gage Dia.	Coating				
									C3	GP3	GP50	AC3	AC50
FLF-3M200R-CB	553M200PR	2.00	0.13/0.25	3.31	4.95	8.74	10.29	9.53	●	●	●	●	●
FLF-3M200L-CB	553M200PL	2.00	0.13/0.25	3.31	4.95	8.74	10.29	9.53	●	●	●	●	●
FLF-3M300R-CB	553M300PR	3.00	0.13/0.25	4.57	4.95	8.74	10.29	9.53	●	●	●	●	●
FLF-3M300L-CB	553M300PL	3.00	0.13/0.25	4.57	4.95	8.74	10.29	9.53	●	●	●	●	●
FLF-3125R-CB	563025PR	3.18	0.13/0.25	4.57	4.95	8.74	10.29	9.53	●	●	●	●	●
FLF-3125L-CB	563025PL	3.18	0.13/0.25	4.57	4.95	8.74	10.29	9.53	●	●	●	●	●
FLF-3156R-CB	563056PR	3.96	0.13/0.25	4.57	4.95	8.74	10.29	9.53	●	●	●	●	●
FLF-3156L-CB	563056PL	3.96	0.13/0.25	4.57	4.95	8.74	10.29	9.53	●	●	●	●	●
FLF-3188R-CB	563088PR	4.77	0.51/0.64	4.57	4.95	8.74	10.29	9.53	●	●	●	●	●
FLF-3188L-CB	563088PL	4.77	0.51/0.64	4.57	4.95	8.74	10.29	9.53	●	●	●	●	●

FACE GROOVING

FLF

■ For holders see next page.

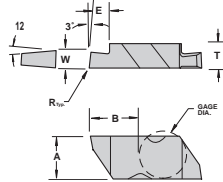

Description	EDP Code	W	R	E	T	A	B	Gage Dia.	Coating				
									C3	GP3	GP50	AC3	AC50
FLF-3M200R	553M200R	2.00	0.13/0.25	3.31	4.95	8.74	10.29	9.53	●	●	●	●	●
FLF-3M200L	553M200L	2.00	0.13/0.25	3.31	4.95	8.74	10.29	9.53	●	●	●	●	●
FLF-3M300R	553M300R	3.00	0.13/0.25	4.57	4.95	8.74	10.29	9.53	●	●	●	●	●
FLF-3M300L	553M300L	3.00	0.13/0.25	4.57	4.95	8.74	10.29	9.53	●	●	●	●	●
FLF-3125R	563025R	3.18 (.125)	0.13/0.25	4.57	4.95	8.74	10.29	9.53	●	●	●	●	●
FLF-3125L	563025L	3.18 (.125)	0.13/0.25	4.57	4.95	8.74	10.29	9.53	●	●	●	●	●
FLF-3156R	563056R	3.96 (.156)	0.13/0.25	4.57	4.95	8.74	10.29	9.53	●	●	●	●	●
FLF-3156L	563056L	3.96 (.156)	0.13/0.25	4.57	4.95	8.74	10.29	9.53	●	●	●	●	●
FLF-3188R	563088R	4.77 (.188)	0.51/0.64	4.57	4.95	8.74	10.29	9.53	●	●	●	●	●
FLF-3188L	563088L	4.77 (.188)	0.51/0.64	4.57	4.95	8.74	10.29	9.53	●	●	●	●	●

FLFD

Single ended - Deep Grooving

■ For holders see next page.

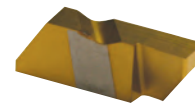
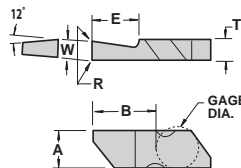

Description	EDP Code	W	R	T	E	A	B	Gage Dia.	Coating				
									C3	C6H	GP3	GP50	AC3
FLFD-3M300R	633M300R	3.00	0.13/0.25	4.95	6.86	8.74	12.83	9.53	●	●	●	●	●
FLFD-3M300L	633M300L	3.00	0.13/0.25	4.95	6.86	8.74	12.83	9.53	●	●	●	●	●
FLFD-3125R	6338125R	3.18 (.125)	0.13/0.25	4.95	6.86	8.74	12.83	9.53	●	●	●	●	●
FLFD-3125L	6338125L	3.18 (.125)	0.13/0.25	4.95	6.86	8.74	12.83	9.53	●	●	●	●	●
FLFD-4189R	6348189R	4.80 (.189)	0.51/0.64	6.48	9.91	11.51	19.33	9.53	●	●	●	●	●
FLFD-4189L	6348189L	4.80 (.189)	0.51/0.64	6.48	9.91	11.51	19.33	9.53	●	●	●	●	●
FLFD-4250R	6348250R	6.35 (.250)	0.51/0.64	6.48	13.21	11.51	22.50	9.53	●	●	●	●	●
FLFD-4250L	6348250L	6.35 (.250)	0.51/0.64	6.48	13.21	11.51	22.50	9.53	●	●	●	●	●

FLFD-CB

Single ended - Deep Grooving

w/Patented chipbreaker

Exclusive patented design!

■ For holders see next page.

RH SHOWN

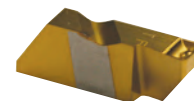

Description	EDP Code	W	R	T	E	A	B	Gage Dia.	Coating				
									C3	C6H	GP3	GP50	AC3
FLFD-3M300R-CB	633M300PR	3.00	0.13/0.25	4.95	6.86	8.74	12.83	9.53	●	●	●	●	●
FLFD-3M300L-CB	633M300PL	3.00	0.13/0.25	4.95	6.86	8.74	12.83	9.53	●	●	●	●	●
FLFD-3125R-CB	6338125PR	3.18 (.125)	0.13/0.25	4.95	6.86	8.74	12.83	9.53	●	●	●	●	●
FLFD-3125L-CB	6338125PL	3.18 (.125)	0.13/0.25	4.95	6.86	8.74	12.83	9.53	●	●	●	●	●
FLFD-4189R-CB	6348189PR	4.80 (.189)	0.51/0.64	6.48	9.91	11.51	19.33	9.53	●	●	●	●	●
FLFD-4189L-CB	6348189PL	4.80 (.189)	0.51/0.64	6.48	9.91	11.51	19.33	9.53	●	●	●	●	●
FLFD-4250R-CB	6348250PR	6.35 (.250)	0.51/0.64	6.48	12.70	11.51	22.50	9.53	●	●	●	●	●
FLFD-4250L-CB	6348250PL	6.35 (.250)	0.51/0.64	6.48	12.70	11.51	22.50	9.53	●	●	●	●	●

In an effort to improve our stock standard grade offering, there are periodic changes. Please see current price list for up to date grade offering.

- High performance choice in optimal conditions.
- ▲ Recommended grade under general conditions.

Material	GP3	GP50	AC3	AC50
Cast Iron	▲	●	●	●
Non-Ferrous	●	●	●	●
Stainless/High Temp	▲	●	●	●
Steel	●	▲	●	●



FACE GROOVING

EXTERNAL HOLDERS

FLER/L

90° for FLF/FLFD inserts

See coolant fed clamps available
(TF-CP clamps on page 60)

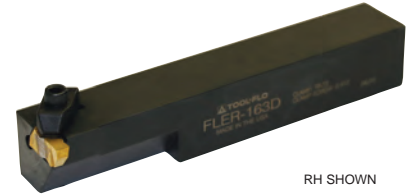
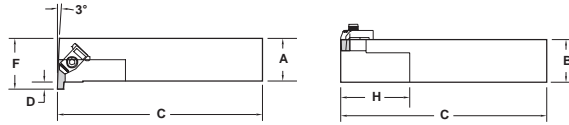

Description	EDP Code	Insert	A	B	C	D	F	H	Clamp	Clamp Screw
FLER-2020M3B	931020M16B	FL-3L	20.00	20.00	114.00	5.33	28.58	38.10	TF-73	SSM-51
FLEL-2020M3B	930020M16B	FL-3R	20.00	20.00	114.00	5.33	28.58	38.10	TF-72	SSM-51
FLER-2525M3D	931025M16D	FL-3L	25.00	25.00	152.00	5.33	31.75	50.80	TF-73	SSM-51
FLEL-2525M3D	930025M16D	FL-3R	25.00	25.00	152.00	5.33	31.75	50.80	TF-72	SSM-51
FLER-3232M3D	931032M16D	FL-3L	32.00	32.00	152.00	5.33	38.10	50.80	TF-73	SSM-51
FLEL-3232M3D	930032M16D	FL-3R	32.00	32.00	152.00	5.33	38.10	50.80	TF-72	SSM-51
FLER-2525M4D	931025M20D	FL-4L	25.00	25.00	152.00	7.37	34.93	50.80	TF-73	SSM-51
FLEL-2525M4D	930025M20D	FL-4R	25.00	25.00	152.00	7.37	34.93	50.80	TF-72	SSM-51
FLER-3232M4D	931032M20D	FL-4L	32.00	32.00	152.00	7.37	41.28	50.80	TF-73	SSM-51
FLEL-3232M4D	930032M20D	FL-4R	32.00	32.00	152.00	7.37	41.28	50.80	TF-72	SSM-51
FLER-3232M6D	931032M28D	FL-6L	32.00	32.00	152.00	7.37	41.28	50.80	TF-121	SSM-51
FLEL-3232M6D	930032M28D	FL-6R	32.00	32.00	152.00	7.37	41.28	50.80	TF-120	SSM-51

FLSR/L

Straight for FLF/FLFD inserts

See coolant fed clamps available
(TF-CP clamps on page 60)

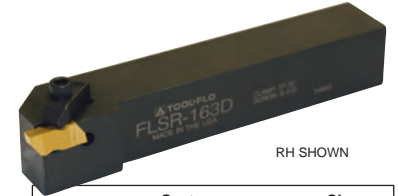
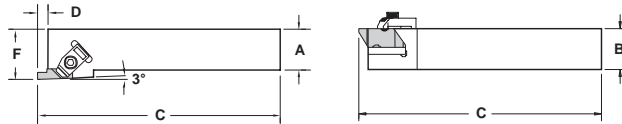

Description	EDP Code	Insert	A	B	C	D	F*	Seat	Seat Screw	Clamp	Clamp Screw
FLSR-2020M3B	934020M16B	FL-3R	20.00	20.00	114.00	5.33	25.40	---	---	TF-73	SSM-51
FLSL-2020M3B	933020M16B	FL-3L	20.00	20.00	114.00	5.33	25.40	---	---	TF-72	SSM-51
FLSR-2525M3C	934025M16C	FL-3R	25.00	25.00	127.00	5.33	31.75	---	---	TF-72	SSM-51
FLSL-2525M3C	933025M16C	FL-3L	25.00	25.00	127.00	5.33	31.75	---	---	TF-73	S-412
FLSR-2525M3D	934025M16D	FL-3R	25.00	25.00	152.00	5.33	31.75	---	---	TF-72	S-412
FLSL-2525M3D	933025M16D	FL-3L	25.00	25.00	152.00	5.33	31.75	---	---	TF-73	S-412
FLSR-3232M3D	934032M16D	FL-3R	32.00	32.00	152.00	5.33	38.10	---	---	TF-72	S-412
FLSL-3232M3D	933032M16D	FL-3L	32.00	32.00	152.00	5.33	38.10	---	---	TF-73	S-412
FLSR-2525M4D	934025M20D	FL-4R	25.00	25.00	152.00	7.37	31.75	SM-420	SL-344	TF-72	S-412
FLSL-2525M4D	933025M20D	FL-4L	25.00	25.00	152.00	7.37	31.75	SM-420	SL-344	TF-73	S-412
FLSR-3232M4D	934032M20D	FL-4R	32.00	32.00	152.00	7.37	38.10	SM-420	SL-344	TF-72	S-412
FLSL-3232M4D	933032M20D	FL-4L	32.00	32.00	152.00	7.37	38.10	SM-420	SL-344	TF-73	S-412
FLSR-3232M6D	934032M28D	FL-6R	32.00	32.00	152.00	7.37	38.10	SM-416	SL-111	TF-120	S-412
FLSL-3232M6D	933032M28D	FL-6L	32.00	32.00	152.00	7.37	38.10	SM-416	SL-111	TF-121	S-412

FACE/DEEP GROOVING

FLFT

Double ended - Deep Face Grooving

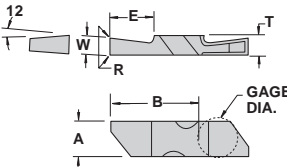

Description	EDP Code	W	R	T	E	A	B	Gage Dia	Uncoated	TIN Coated	ALTiN Coated			
									C3	CBH	GP3	GP50	AC3	AC50
FLFT-3125R	6339125R	3.18 (.125)	0.13/0.25	4.95	9.53	8.74	21.72	9.53			●	●	●	
FLFT-3125L	6339125L	3.18 (.125)	0.13/0.25	4.95	9.53	8.74	21.72	9.53			●	●	●	
FLFT-4189R	6349189R	4.80 (.189)	0.51/0.64	6.48	13.97	11.51	28.85	9.53			●	●	●	
FLFT-4189L	6349189L	4.80 (.189)	0.51/0.64	6.48	13.97	11.51	28.85	9.53			●	●	●	
FLFT-4250R	6349250R	6.35 (.250)	0.51/0.64	6.48	13.97	11.51	28.85	9.53			●	●	●	
FLFT-4250L	6349250L	6.35 (.250)	0.51/0.64	6.48	13.97	11.51	28.85	9.53			●	●	●	

Cast Iron			▲	●
Non-Ferrous	●		▲	
Stainless/High Temp		▲	●	
Steel			▲	●

EXTERNAL HOLDERS

FLSRT/LT

Straight for FLFT inserts

See coolant fed clamps available
(TF-CP clamps on page 60)

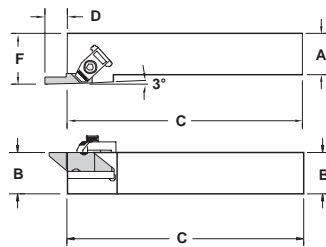

Description	EDP Code	Insert	A	B	C	D	F	Clamp	Clamp Screw
FLSRT-2525M3D	934325M16D	FL_T-3R	25.00	25.00	152.00	11.18	31.75	TF-72	SSM-51
FLSLT-2525M3D	934225M16D	FL_T-3L	25.00	25.00	152.00	11.18	31.75	TF-73	SSM-51
FLSRT-3232M3D	934332M16D	FL_T-3R	32.00	32.00	152.00	11.18	38.10	TF-72	SSM-51
FLSLT-3232M3D	934232M16D	FL_T-3L	32.00	32.00	152.00	11.18	38.10	TF-73	SSM-51
FLSRT-2525M4D	934325M20D	FL_T-4R	25.00	25.00	152.00	14.22	31.75	TF-72	SSM-51
FLSLT-2525M4D	934225M20D	FL_T-4L	25.00	25.00	152.00	14.22	31.75	TF-73	SSM-51
FLSRT-3232M4D	934332M20D	FL_T-4R	32.00	32.00	152.00	14.22	38.10	TF-72	SSM-51
FLSLT-3232M4D	934232M20D	FL_T-4L	32.00	32.00	152.00	14.22	38.10	TF-73	SSM-51

FACE GROOVING



INTERNAL FACE GROOVING

FLFD-I

Single ended - Internal Deep/Face Grooving

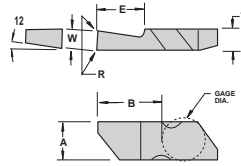

RH SHOWN

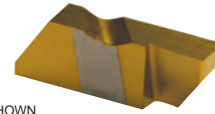

Description	EDP Code	W	R	T	E	A	B	Gage Dia	Coatings						
									C3	C6H	GP3	GP50	AC3	AC50	
FLFD-3125RI	6338125RI	3.18 (.125)	0.13/0.25	4.95	6.86	8.74	12.83	9.53				●	●	●	
FLFD-3125LI	6338125LI	3.18 (.125)	0.13/0.25	4.95	6.86	8.74	12.83	9.53				●	●	●	
FLFD-3189RI	6338189RI	4.80 (.189)	0.51/0.64	4.95	6.86	8.74	12.83	9.53				●	●	●	
FLFD-3189LI	6338189LI	4.80 (.189)	0.51/0.64	4.95	6.86	8.74	12.83	9.53				●	●	●	

INTERNAL FACE GROOVING

FLFD-I-CB

Single ended - Internal Deep/Face Grooving

w/Patented chipbreaker

Exclusive patented design!

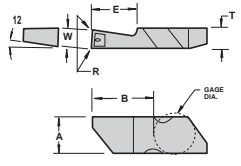

RH SHOWN

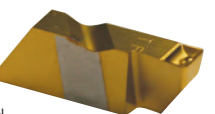

Description	EDP Code	W	R	T	E	A	B	Gage Dia	Coatings						
									C3	C6H	GP3	GP50	AC3	AC50	
FLFD-3125RI-CB	6338125PRI	3.18 (.125)	0.13/0.25	4.95	6.86	8.74	12.83	9.53				●	●	●	
FLFD-3125LI-CB	6338125PLI	3.18 (.125)	0.13/0.25	4.95	6.86	8.74	12.83	9.53				●	●	●	
FLFD-3189RI-CB	6338189PRI	4.80 (.189)	0.51/0.64	4.95	6.86	8.74	12.83	9.53				●	●	●	
FLFD-3189LI-CB	6338189PLI	4.80 (.189)	0.51/0.64	4.95	6.86	8.74	12.83	9.53				●	●	●	

In an effort to improve our stock standard grade offering, there are periodic changes. Please see current price list for up to date grade offering.

- High performance choice in optimal conditions.
- ▲ Recommended grade under general conditions.

Material	C3	C6H	GP3	GP50	AC3	AC50
Cast Iron			▲	●		●
Non-Ferrous			●	●	●	●
Stainless/High Temp		▲		●		●
Steel				▲		●

INTERNAL BARS

A-FLSR/L

For FLFD-I inserts

w/Coolant hole

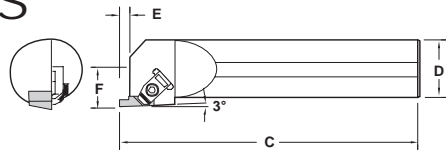

RH SHOWN

Description	EDP Code	Insert	Min. Bore	E	D	C	F	Clamp	
								Clamp	Clamp Screw
A25M-FLSR3	965225M16	FLFD-3RI	57.15	7.37	25.00	300.00	16.26	TF-72	SSM-51
A25M-FLSL3	964225M16	FLFD-3LI	57.15	7.37	25.00	300.00	16.26	TF-73	SSM-51
A32M-FLSR3	965232M16	FLFD-3RI	57.15	7.37	32.00	350.00	19.43	TF-72	SSM-51
A32M-FLSL3	964232M16	FLFD-3LI	57.15	7.37	32.00	350.00	19.43	TF-73	SSM-51
A40M-FLSR3	965240M16	FLFD-3RI	57.15	7.37	40.00	350.00	22.61	TF-72	SSM-51
A40M-FLSL3	964240M16	FLFD-3LI	57.15	7.37	40.00	350.00	22.61	TF-73	SSM-51
A45M-FLSR3	965245M16	FLFD-3RI	57.15	7.37	45.00	350.00	25.78	TF-72	SSM-51
A45M-FLSL3	964245M16	FLFD-3LI	57.15	7.37	45.00	350.00	25.78	TF-73	SSM-51
A50M-FLSR3	965250M16	FLFD-3RI	60.33	7.37	50.00	400.00	32.54	TF-72	SSM-51
A50M-FLSL3	964250M16	FLFD-3LI	60.33	7.37	50.00	400.00	32.54	TF-73	SSM-51

FACE GROOVING

VDB

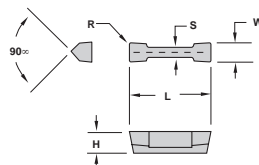

Description	EDP Code	W	R	L	H	S	Coatings					
							C25	C3	GP3	GP50	AC3	AC50
VDB 125 A008	79125A08	3.18 (.125)	0.20	28.58	6.35	2.69						
VDB 125 A015	79125A	3.18 (.125)	0.38	28.58	6.35	2.69	●		●	●	●	●
VDB 156 A008	79156A08	3.96 (.156)	0.20	28.58	6.35	2.69						
VDB 156 A015	79156A	3.96 (.156)	0.38	28.58	6.35	2.69			●	●	●	●
VDB 188 A008	79188A08	4.78 (.188)	0.20	28.58	6.35	3.66						
VDB 188 A015	79188A	4.78 (.188)	0.38	28.58	6.35	3.66	●		●	●	●	●
VDB 188 A031	79188A031	4.78 (.188)	0.79	28.58	6.35	3.66			●	●	●	●
VDB 218-A015	79218A	5.54 (.218)	0.38	28.58	6.35	3.66			●	●	●	●
VDB 250 A015	79250A	6.35 (.250)	0.38	28.58	6.35	3.66	●		●	●	●	●
VDB 250 B015	79250B	6.35 (.250)	0.38	28.58	8.56	3.66			●	●	●	●
VDB 250 B031	79250B031	6.35 (.250)	0.79	28.58	8.56	3.66			●	●	●	●
VDB 281 B015	79281B	7.14 (.281)	0.38	28.58	8.56	5.13			●	●	●	●
VDB 312 B015	79312B	7.92 (.312)	0.38	28.58	8.56	5.13			●	●	●	●
VDB 312 B031	79312B031	7.92 (.312)	0.79	28.58	8.56	5.13			●	●	●	●
VDB 344 B015	79344B	8.74 (.344)	0.38	28.58	8.56	7.01			●	●	●	●
VDB 344 B031	79344B031	8.74 (.344)	0.79	28.58	8.56	7.01			●	●	●	●
VDB 375 B015	79375B	9.53 (.375)	0.38	28.58	8.56	7.01			●	●	●	●
VDB 375 B031	79375B031	9.53 (.375)	0.79	28.58	8.56	7.01			●	●	●	●

In an effort to improve our stock standard grade offering, there are periodic changes. Please see current price list for up to date grade offering.

- High performance choice in optimal conditions.
- ▲ Recommended grade under general conditions.

Material	C25	C3	GP3	GP50	AC3	AC50
Cast Iron			▲	●		●
Non-Ferrous		●		▲		
Stainless/High Temp		▲		●		
Steel				▲		●



FACE GROOVING

FACE GROOVING

VDB-CB

w/Patented chipbreaker

Exclusive patented design!

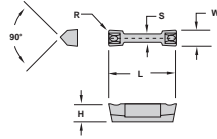

Description	EDP Code	W	R	L	H	S	Coating					
							C25	C3	GP3	GP50	AC3	AC50
VDB 125 A008-CB	79125A08P	3.18 (.125)	0.20	28.58	6.35	2.69	●	●	●	●	●	●
VDB 125 A015-CB	79125AP	3.18 (.125)	0.38	28.58	6.35	2.69	●	●	●	●	●	●
VDB 156 A008-CB	79156A08P	3.96 (.156)	0.20	28.58	6.35	2.69	●	●	●	●	●	●
VDB 156 A015-CB	79156AP	3.96 (.156)	0.38	28.58	6.35	2.69	●	●	●	●	●	●
VDB 188 A008-CB	79188A08P	4.78 (.188)	0.20	28.58	6.35	3.66	●	●	●	●	●	●
VDB 188 A015-CB	79188AP	4.78 (.188)	0.38	28.58	6.35	3.66	●	●	●	●	●	●
VDB 188 A031-CB	79188A031P	4.78 (.188)	0.79	28.58	6.35	3.66	●	●	●	●	●	●
VDB 218-A015-CB	79218AP	5.54 (.218)	0.38	28.58	6.35	3.66	●	●	●	●	●	●
VDB 250 B015-CB	79250BP	6.35 (.250)	0.38	28.58	8.56	3.66	●	●	●	●	●	●
VDB 250 B031-CB	79250B031P	6.35 (.250)	0.79	28.58	8.56	3.66	●	●	●	●	●	●
VDB 312 B015-CB	79312BP	7.92 (.312)	0.38	28.58	8.56	5.13	●	●	●	●	●	●
VDB 312 B031-CB	79312B031P	7.92 (.312)	0.79	28.58	8.56	5.13	●	●	●	●	●	●
VDB 375 B015-CB	79375BP	9.53 (.375)	0.38	28.58	8.56	7.01	●	●	●	●	●	●
VDB 375 B031-CB	79375B031P	9.53 (.375)	0.79	28.58	8.56	7.01	●	●	●	●	●	●

In an effort to improve our stock standard grade offering, there are periodic changes. Please see current price list for up to date grade offering.

- High performance choice in optimal conditions.
- ▲ Recommended grade under general conditions.

Material	Cast Iron	Non-Ferrous	Stainless/High Temp	Steel
Coating	▲	●	▲	●

EXTERNAL 90° HOLDER

CDHOR/L (RH HOLDERS USE LH COMPONENTS)

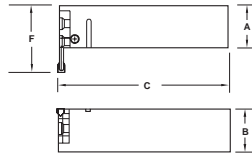

RH SHOWN

Description	EDP Code	A	B	C	F*		Clamp Screw	Stop Screw	Anvil Screw
					.312(1)	.812(1)			
CDHOR-25M	921025M00	25.0	25.0	152.00	33.32	46.02	SB90	SS20	SF95
CDHOR-32M	921032M00	32.0	32.0	152.00	39.67	52.37	SB90	SS20	SF95
CDHOR-40M	921040M00	40.0	40.0	152.00	46.02	58.72	SB90	SS20	SF95
CDHOR-40M	920040M00	40.0	40.0	152.00	46.02	58.72	SB90	SS20	SF95

*The "F" dimension is determined by the D.O.C. of the anvil.

EXTERNAL STRAIGHT HOLDER

CDVOR/L (RH HOLDERS USE RH COMPONENTS)

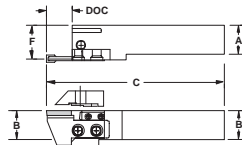

RH SHOWN

Description	EDP Code	A	B	C	F	Clamp Screw	Stop Screw	Anvil Screw
CDVOR-32M	924032M00	32.0	32.0	*	35.56	SBM90	SSM20	SFM95
CDVOR-40M	924040M00	40.0	40.0	*	41.91	SBM90	SSM20	SFM95
CDVOR-40M	923040M00	40.0	40.0	*	41.91	SBM90	SSM20	SFM95

*The "C" dimension is determined by the D.O.C. of the anvil.

FACE GROOVING COMPONENTS

FOR CDHOR/L AND CDVOR/L

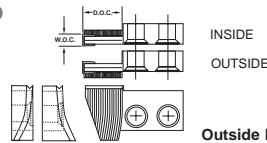

RH SHOWN

Description	EDP Code	Insert	Outside Dia. Range	DOC	WOC	Clamp	Stop Block
AFHR-128-O	91211280	DBP24/VDB125	69.85-76.20	16.51	2.67-3.18	CHRF-282O	SBH-2
AFHL-128-I	91201281	DBP24/VDB125	69.85-76.20	16.51	2.67-3.18	CHLF-282I	SBH-2
AFHL-128-O	91201280	DBP24/VDB125	69.85-76.20	16.51	2.67-3.18	CHLF-282O	SBH-2
AFHR-138-I	91211381	DBP34/VDB188	76.20-101.60	16.51	4.32-4.78	CHRF-382I	SBH-2
AFHR-138-O	91211380	DBP34/VDB188	76.20-101.60	16.51	4.32-4.78	CHRF-382O	SBH-2
AFHL-138-I	91201381	DBP34/VDB188	76.20-101.60	16.51	4.32-4.78	CHLF-382I	SBH-2
AFHL-138-O	91201380	DBP34/VDB188	76.20-101.60	16.51	4.32-4.78	CHLF-382O	SBH-2
AFHR-148-I	91211481	VDB250A	76.20-101.60	20.62	5.59-6.35	CHRF-482I	SBH-1
AFHR-148-O	91211480	VDB250A	76.20-101.60	20.62	5.59-6.35	CHRF-482O	SBH-1
AFHL-148-I	91201481	VDB250A	76.20-101.60	20.62	5.59-6.35	CHLF-482I	SBH-1
AFHL-148-O	91201480	VDB250A	76.20-101.60	20.62	5.59-6.35	CHLF-482O	SBH-1
AFHR-248-I	91212481	DBP45/VDB250B	101.60-152.40	20.62	6.35-7.93	CHRF-482I	SBH-1
AFHR-248-O	91212480	DBP45/VDB250B	101.60-152.40	20.62	6.35-7.93	CHRF-482O	SBH-1
AFHL-248-I	91202481	DBP45/VDB250B	101.60-152.40	20.62	6.35-7.93	CHLF-482I	SBH-1
AFHL-248-O	91202480	DBP45/VDB250B	101.60-152.40	20.62	6.35-7.93	CHLF-482O	SBH-1
AFHR-268-I	91212681	DBP65/VDB375	152.40-304.80	20.62	8.89-9.53	CHRF-582I	SBH-1
AFHR-268-O	91212680	DBP65/VDB375	152.40-304.80	20.62	8.89-9.53	CHRF-582O	SBH-1
AFHL-268-I	91202681	DBP65/VDB375	152.40-304.80	20.62	8.89-9.53	CHLF-582I	SBH-1
AFHL-268-O	91202680	DBP65/VDB375	152.40-304.80	20.62	8.89-9.53	CHLF-582O	SBH-1



Guidelines for Face Grooving Operations

EXTERNAL

STANDARD FLF/FLFD INSERTS

insert type	maximum groove depth "B"	minimum groove diameter "C"
FLF-3	1.52	23.88
FLF-3	2.29	30.48
FLF-3	3.18	36.07
FLF-3	3.81	41.28
FLFD-3	6.35	47.63
FLF-4/6	1.52	23.88
FLF-4/6	2.29	30.48
FLF-4/6	3.18	36.07
FLF-4/6	3.81	41.28
FLF-4/6	4.78	47.63
FLF-4/6	6.35	57.15
FLFD-4	9.53	57.15
FLFD-4	12.70	57.15

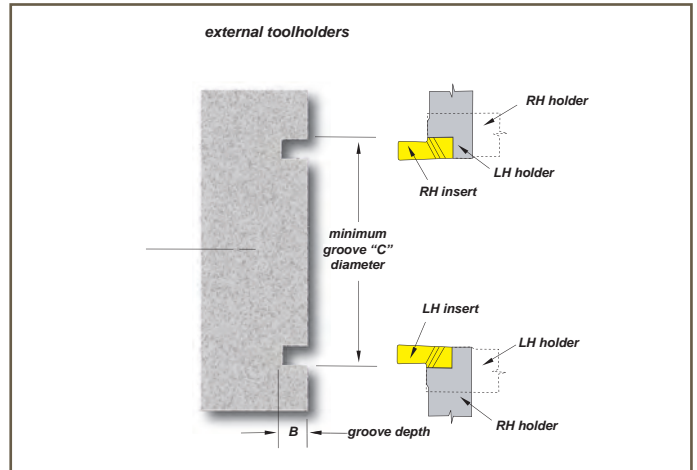

STANDARD FLG/FLGD INSERTS

insert type	maximum groove depth "B"	minimum groove diameter "C"
FLG-2	1.52	53.98
FLG-2	2.39	88.90
FLG-3	2.39	101.60
FLG-3	3.18	127.00
FLG-3	3.81	139.70
FLGD-3	6.35	174.63
FLG-4	3.81	152.40
FLG-4	6.35	209.55
FLGD-4	9.53	222.25
FLGD-4	12.70	222.25
FLG-5	9.53	330.20

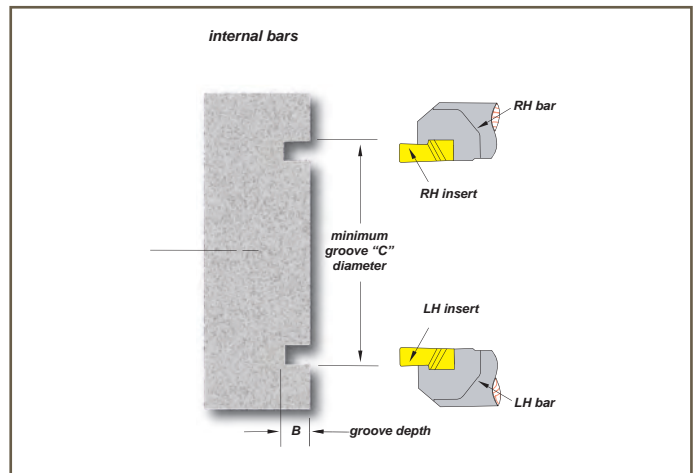

INTERNAL

insert type	maximum groove depth "D"	minimum groove diameter "E"
FLFD-3-R	6.35	57.15

Also check minimum bore diameter of boring bar.

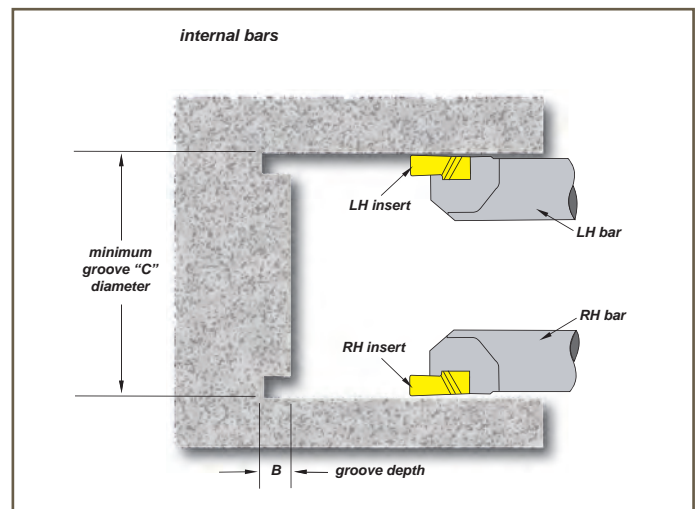



FLO-LOCK

Threading & Grooving



Flo-Lock Grooving/Threading Insert Identification Chart

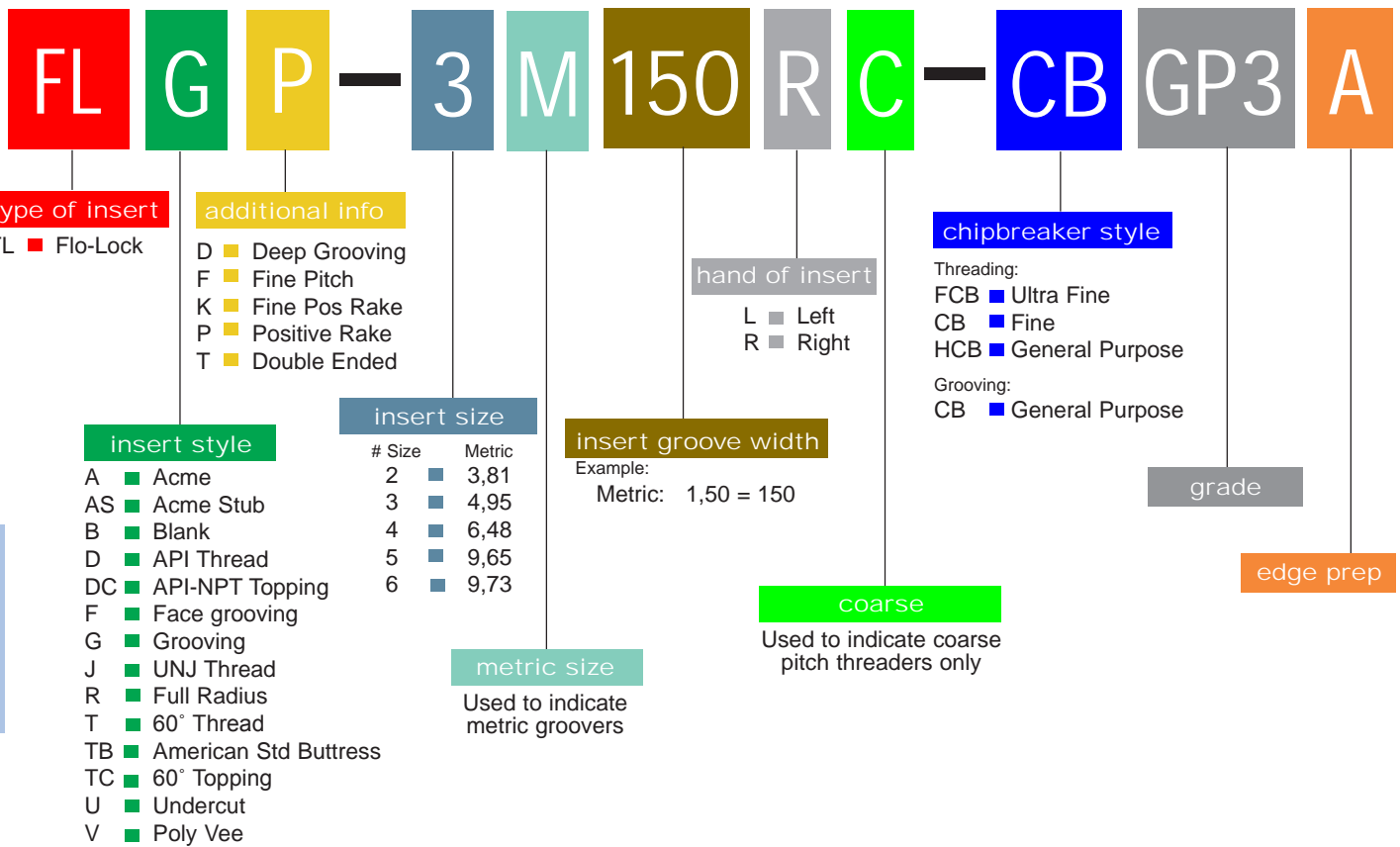

FLO-LOCK

Flo-Lock Cross Reference Chart

STYLE	TOOL-FLO	KENNAMETAL®	SANDVIK®	VALENITE®	HORIZON®	RTW®
ACME	FLA	NA	TLA	VLA	HA	PA
ACME STUB	FLAS	NAS	TLAS	VLAS	HAS	PAS
API-NON TOPPING	FLD	ND	TLD	#	#	#
API-TOPPING	FLDC	NDC	TLDC	#	HDC	PDC
DEEP GROOVING	FLGD	NGD	#	#	HGD	#
FACE GROOVING	FLF	NF	TLF	#	HF	#
GROOVING	FLG	NG	TLG	VLG	HG	PG
GROOVING-POSITIVE	FLGP	NGP	TLGP	VLGD	HGD	PGD
UNJ	FLJ	NJ	TLJ	#	HJ	#
UNJ-FINE PITCH	FLJF	NJF	TLJF	#	HJF	#
UNJ-FINE PITCH-POSITIVE	FLJK	NJK	TLJK	#	#	#
UNJ-POSITIVE	FLJP	NJP	TLJP	#	#	#
PROFILING - LH	FLPL	NPL	#	#	#	#
PROFILING - RH	FLPR	NPR	#	#	#	#
GROOVING - Full Nose Radius	FLR	NR	TLR	VLR	HR	PR
GROOVING - Full Nose Radius Pos.	FLRP	NRP	TLRP	VLRD	HRP	PRP
60° V	FLT	NT	TLT	VLT	HT	PT
AMERICAN STANDARD BUTTRESS	FLTB	NTB	TLTB	#	HTB	#
UN - UNIFIED	FLTC	NTC	TLTC	VLTC	HTC	PTC
60° V - FINE PITCH	FLTF	NTF	TLTF	VLTF	HTF	PTF
60° V - FINE PITCH POSITIVE	FLTK	NTK	TLTK	VLTK	HTK	PTK
60° V - POSITIVE	FLTP	NTP	TLTP	VLTP	HTP	PTP
POLY-V GROOVING	FLV	NV	TLV	#	HV	#

*Top Clamp change is required when converting from SANDVIK®



GROOVING-CHIP-FLO

FLG-CB

w/patented chipbreaker

Exclusive patented design!

Features:

- Patented chipbreaker - Patent No. 6,146,064
- Maximum chip control
- Industry standard widths

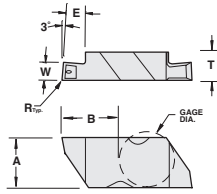

RH Shown

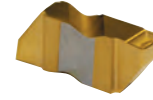

Description	EDP Code	W		R	E	T	A	B	Gage Dia.	TIN Coated		ALTiN Coated		
		mm	(Inch)							GP3	GP50	AC22	AC3	AC50
FLG-2M100R-CB	562M100PR	1.00	(.039")	0.05/0.13	1.90	3.81	5.56	6.86	4.76	●	●	●	●	●
FLG-2M100L-CB	562M100PL	1.00	(.039")	0.05/0.13	1.90	3.81	5.56	6.86	4.76	●	●	●	●	●
FLG-2M120R-CB	562M120PR	1.20	(.047")	0.05/0.13	2.79	3.81	5.56	6.86	4.76	●	●	●	●	●
FLG-2M120L-CB	562M120PL	1.20	(.047")	0.05/0.13	2.79	3.81	5.56	6.86	4.76	●	●	●	●	●
FLG-2M140R-CB	562M140PR	1.40	(.055")	0.05/0.13	2.79	3.81	5.56	6.86	4.76	●	●	●	●	●
FLG-2M140L-CB	562M140PL	1.40	(.055")	0.05/0.13	2.79	3.81	5.56	6.86	4.76	●	●	●	●	●
FLG-2M150R-CB	562M150PR	1.50	(.059")	0.05/0.13	2.79	3.81	5.56	6.86	4.76	●	●	●	●	●
FLG-2M150L-CB	562M150PL	1.50	(.059")	0.05/0.13	2.79	3.81	5.56	6.86	4.76	●	●	●	●	●
FLG-2M170R-CB	562M170PR	1.70	(.067")	0.05/0.13	2.79	3.81	5.56	6.86	4.76	●	●	●	●	●
FLG-2M170L-CB	562M170PL	1.70	(.067")	0.05/0.13	2.79	3.81	5.56	6.86	4.76	●	●	●	●	●
FLG-2M175R-CB	562M175PR	1.75	(.069")	0.05/0.13	2.79	3.81	5.56	6.86	4.76	●	●	●	●	●
FLG-2M175L-CB	562M175PL	1.75	(.069")	0.05/0.13	2.79	3.81	5.56	6.86	4.76	●	●	●	●	●
FLG-2M195R-CB	562M195PR	1.95	(.077")	0.05/0.13	2.79	3.81	5.56	6.86	4.76	●	●	●	●	●
FLG-2M195L-CB	562M195PL	1.95	(.077")	0.05/0.13	2.79	3.81	5.56	6.86	4.76	●	●	●	●	●
FLG-2M200R-CB	562M200PR	2.00	(.079")	0.05/0.13	2.79	3.81	5.56	6.86	4.76	●	●	●	●	●
FLG-2M200L-CB	562M200PL	2.00	(.079")	0.05/0.13	2.79	3.81	5.56	6.86	4.76	●	●	●	●	●
FLG-2M220R-CB	562M220PR	2.20	(.087")	0.05/0.13	2.79	3.81	5.56	6.86	4.76	●	●	●	●	●
FLG-2M220L-CB	562M220PL	2.20	(.087")	0.05/0.13	2.79	3.81	5.56	6.86	4.76	●	●	●	●	●
FLG-2M225R-CB	562M225PR	2.25	(.089")	0.05/0.13	2.79	3.81	5.56	6.86	4.76	●	●	●	●	●
FLG-2M225L-CB	562M225PL	2.25	(.089")	0.05/0.13	2.79	3.81	5.56	6.86	4.76	●	●	●	●	●
FLG-2M250R-CB	562M250PR	2.50	(.098")	0.05/0.13	2.79	3.81	5.56	6.86	4.76	●	●	●	●	●
FLG-2M250L-CB	562M250PL	2.50	(.098")	0.05/0.13	2.79	3.81	5.56	6.86	4.76	●	●	●	●	●
FLG-2M275R-CB	562M275PR	2.75	(.109")	0.05/0.13	2.79	3.81	5.56	6.86	4.76	●	●	●	●	●
FLG-2M275L-CB	562M275PL	2.75	(.109")	0.05/0.13	2.79	3.81	5.56	6.86	4.76	●	●	●	●	●
FLG-2M300R-CB	562M300PR	3.00	(.118")	0.05/0.13	2.79	3.81	5.56	6.86	4.76	●	●	●	●	●
FLG-2M300L-CB	562M300PL	3.00	(.118")	0.05/0.13	2.79	3.81	5.56	6.86	4.76	●	●	●	●	●
FLG-2M325R-CB	562M325PR	3.25	(.128")	0.05/0.13	2.79	3.81	5.56	6.86	4.76	●	●	●	●	●
FLG-2M325L-CB	562M325PL	3.25	(.128")	0.05/0.13	2.79	3.81	5.56	6.86	4.76	●	●	●	●	●
FLG-3M100R-CB	563M100PR	1.00	(.039")	0.05/0.13	1.91	4.95	8.74	10.29	9.53	●	●	●	●	●
FLG-3M100L-CB	563M100PL	1.00	(.039")	0.05/0.13	1.91	4.95	8.74	10.29	9.53	●	●	●	●	●
FLG-3M120R-CB	563M120PR	1.20	(.047")	0.05/0.13	1.91	4.95	8.74	10.29	9.53	●	●	●	●	●
FLG-3M120L-CB	563M120PL	1.20	(.047")	0.05/0.13	1.91	4.95	8.74	10.29	9.53	●	●	●	●	●
FLG-3M150R-CB	563M150PR	1.50	(.059")	0.05/0.13	3.05	4.95	8.74	10.29	9.53	●	●	●	●	●
FLG-3M150L-CB	563M150PL	1.50	(.059")	0.05/0.13	3.05	4.95	8.74	10.29	9.53	●	●	●	●	●
FLG-3M170R-CB	563M170PR	1.70	(.067")	0.05/0.13	3.05	4.95	8.74	10.29	9.53	●	●	●	●	●
FLG-3M170L-CB	563M170PL	1.70	(.067")	0.05/0.13	3.05	4.95	8.74	10.29	9.53	●	●	●	●	●
FLG-3M175R-CB	563M175PR	1.75	(.069")	0.05/0.13	3.05	4.95	8.74	10.29	9.53	●	●	●	●	●
FLG-3M175L-CB	563M175PL	1.75	(.069")	0.05/0.13	3.05	4.95	8.74	10.29	9.53	●	●	●	●	●
FLG-3M200R-CB	563M200PR	2.00	(.079")	0.05/0.13	3.05	4.95	8.74	10.29	9.53	●	●	●	●	●
FLG-3M200L-CB	563M200PL	2.00	(.079")	0.05/0.13	3.05	4.95	8.74	10.29	9.53	●	●	●	●	●
FLG-3M220R-CB	563M220PR	2.20	(.087")	0.05/0.13	4.57	4.95	8.74	10.29	9.53	●	●	●	●	●
FLG-3M220L-CB	563M220PL	2.20	(.087")	0.05/0.13	4.57	4.95	8.74	10.29	9.53	●	●	●	●	●
FLG-3M225R-CB	563M225PR	2.25	(.089")	0.05/0.13	4.57	4.95	8.74	10.29	9.53	●	●	●	●	●
FLG-3M225L-CB	563M225PL	2.25	(.089")	0.05/0.13	4.57	4.95	8.74	10.29	9.53	●	●	●	●	●
FLG-3M250R-CB	563M250PR	2.50	(.098")	0.05/0.13	4.57	4.95	8.74	10.29	9.53	●	●	●	●	●
FLG-3M250L-CB	563M250PL	2.50	(.098")	0.05/0.13	4.57	4.95	8.74	10.29	9.53	●	●	●	●	●
FLG-3M275R-CB	563M275PR	2.75	(.109")	0.05/0.13	4.57	4.95	8.74	10.29	9.53	●	●	●	●	●
FLG-3M275L-CB	563M275PL	2.75	(.109")	0.05/0.13	4.57	4.95	8.74	10.29	9.53	●	●	●	●	●
FLG-3M300R-CB	563M300PR	3.00	(.118")	0.05/0.13	4.57	4.95	8.74	10.29	9.53	●	●	●	●	●
FLG-3M300L-CB	563M300PL	3.00	(.118")	0.05/0.13	4.57	4.95	8.74	10.29	9.53	●	●	●	●	●
FLG-3M320R-CB	563M320PR	3.20	(.126")	0.05/0.13	4.57	4.95	8.74	10.29	9.53	●	●	●	●	●
FLG-3M320L-CB	563M320PL	3.20	(.126")	0.05/0.13	4.57	4.95	8.74	10.29	9.53	●	●	●	●	●
FLG-3M325R-CB	563M325PR	3.25	(.128")	0.05/0.13	4.57	4.95	8.74	10.29	9.53	●	●	●	●	●
FLG-3M325L-CB	563M325PL	3.25	(.128")	0.05/0.13	4.57	4.95	8.74	10.29	9.53	●	●	●	●	●
FLG-3M350R-CB	563M350PR	3.50	(.138")	0.05/0.13	4.57	4.95	8.74	10.29	9.53	●	●	●	●	●
FLG-3M350L-CB	563M350PL	3.50	(.138")	0.05/0.13	4.57	4.95	8.74	10.29	9.53	●	●	●	●	●
FLG-3M400R-CB	563M400PR	4.00	(.157")	0.25/0.38	4.57	4.95	8.74	10.29	9.53	●	●	●	●	●
FLG-3M400L-CB	563M400PL	4.00	(.157")	0.25/0.38	4.57	4.95	8.74	10.29	9.53	●	●	●	●	●
FLG-4M320R-CB	564M320PR	3.20	(.126")	0.05/0.13	6.35	6.48	11.51	16.15	9.53	●	●	●	●	●
FLG-4M320L-CB	564M320PL	3.20	(.126")	0.05/0.13	6.35	6.48	11.51	16.15	9.53	●	●	●	●	●

In an effort to improve our stock standard grade offering, there are periodic changes. Please see current price list for up to date grade offering.

- High performance choice in optimal conditions.
- ▲ Recommended grade under general conditions.

	GP3	GP50	AC22	AC3	AC50
Cast Iron	▲				●
Non-Ferrous	▲				●
Stainless/High Temp	▲				●
Steel		▲			●

FLO-LOCK



GROOVING FLG

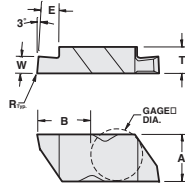

FLO-LOCK

Description	EDP Code	W mm (Inch)	R	E	T	A	B	Gage Dia.	TIN Coated		A/TIN Coated	
									GP3	GP50	AC22	AC3
FLG-2M100R	562M100R	1.00 (.039")	0.05/0.13	1.90	3.81	5.56	6.86	4.76	●	●	●	●
FLG-2M100L	562M100L	1.00 (.039")	0.05/0.13	1.90	3.81	5.56	6.86	4.76	●	●	●	●
FLG-2M120R	562M120R	1.20 (.047")	0.05/0.13	2.79	3.81	5.56	6.86	4.76	●	●	●	●
FLG-2M120L	562M120L	1.20 (.047")	0.05/0.13	2.79	3.81	5.56	6.86	4.76	●	●	●	●
FLG-2M140R	562M140R	1.40 (.055")	0.05/0.13	2.79	3.81	5.56	6.86	4.76	●	●	●	●
FLG-2M140L	562M140L	1.40 (.055")	0.05/0.13	2.79	3.81	5.56	6.86	4.76	●	●	●	●
FLG-2M150R	562M150R	1.50 (.059")	0.05/0.13	2.79	3.81	5.56	6.86	4.76	●	●	●	●
FLG-2M150L	562M150L	1.50 (.059")	0.05/0.13	2.79	3.81	5.56	6.86	4.76	●	●	●	●
FLG-2M170R	562M170R	1.70 (.067")	0.05/0.13	2.79	3.81	5.56	6.86	4.76	●	●	●	●
FLG-2M170L	562M170L	1.70 (.067")	0.05/0.13	2.79	3.81	5.56	6.86	4.76	●	●	●	●
FLG-2M175R	562M175R	1.75 (.069")	0.05/0.13	2.79	3.81	5.56	6.86	4.76	●	●	●	●
FLG-2M175L	562M175L	1.75 (.069")	0.05/0.13	2.79	3.81	5.56	6.86	4.76	●	●	●	●
FLG-2M195R	562M195R	1.95 (.077")	0.05/0.13	2.79	3.81	5.56	6.86	4.76	●	●	●	●
FLG-2M195L	562M195L	1.95 (.077")	0.05/0.13	2.79	3.81	5.56	6.86	4.76	●	●	●	●
FLG-2M200R	562M200R	2.00 (.079")	0.05/0.13	2.79	3.81	5.56	6.86	4.76	●	●	●	●
FLG-2M200L	562M200L	2.00 (.079")	0.05/0.13	2.79	3.81	5.56	6.86	4.76	●	●	●	●
FLG-2M220R	562M220R	2.20 (.087")	0.05/0.13	2.79	3.81	5.56	6.86	4.76	●	●	●	●
FLG-2M220L	562M220L	2.20 (.087")	0.05/0.13	2.79	3.81	5.56	6.86	4.76	●	●	●	●
FLG-2M225R	562M225R	2.25 (.089")	0.05/0.13	2.79	3.81	5.56	6.86	4.76	●	●	●	●
FLG-2M225L	562M225L	2.25 (.089")	0.05/0.13	2.79	3.81	5.56	6.86	4.76	●	●	●	●
FLG-2M250R	562M250R	2.50 (.098")	0.05/0.13	2.79	3.81	5.56	6.86	4.76	●	●	●	●
FLG-2M250L	562M250L	2.50 (.098")	0.05/0.13	2.79	3.81	5.56	6.86	4.76	●	●	●	●
FLG-2M275R	562M275R	2.75 (.109")	0.05/0.13	2.79	3.81	5.56	6.86	4.76	●	●	●	●
FLG-2M275L	562M275L	2.75 (.109")	0.05/0.13	2.79	3.81	5.56	6.86	4.76	●	●	●	●
FLG-2M300R	562M300R	3.00 (.118")	0.05/0.13	2.79	3.81	5.56	6.86	4.76	●	●	●	●
FLG-2M300L	562M300L	3.00 (.118")	0.05/0.13	2.79	3.81	5.56	6.86	4.76	●	●	●	●
FLG-2M325R	562M325R	3.25 (.128")	0.05/0.13	2.79	3.81	5.56	6.86	4.76	●	●	●	●
FLG-2M325L	562M325L	3.25 (.128")	0.05/0.13	2.79	3.81	5.56	6.86	4.76	●	●	●	●
FLG-3M100R	563M100R	1.00 (.039")	0.05/0.13	1.91	4.95	8.74	10.29	9.53	●	●	●	●
FLG-3M100L	563M100L	1.00 (.039")	0.05/0.13	1.91	4.95	8.74	10.29	9.53	●	●	●	●
FLG-3M120R	563M120R	1.20 (.047")	0.05/0.13	1.91	4.95	8.74	10.29	9.53	●	●	●	●
FLG-3M120L	563M120L	1.20 (.047")	0.05/0.13	1.91	4.95	8.74	10.29	9.53	●	●	●	●
FLG-3M150R	563M150R	1.50 (.059")	0.05/0.13	3.05	4.95	8.74	10.29	9.53	●	●	●	●
FLG-3M150L	563M150L	1.50 (.059")	0.05/0.13	3.05	4.95	8.74	10.29	9.53	●	●	●	●
FLG-3M170R	563M170R	1.70 (.067")	0.05/0.13	3.05	4.95	8.74	10.29	9.53	●	●	●	●
FLG-3M170L	563M170L	1.70 (.067")	0.05/0.13	3.05	4.95	8.74	10.29	9.53	●	●	●	●
FLG-3M175R	563M175R	1.75 (.069")	0.05/0.13	3.05	4.95	8.74	10.29	9.53	●	●	●	●
FLG-3M175L	563M175L	1.75 (.069")	0.05/0.13	3.05	4.95	8.74	10.29	9.53	●	●	●	●
FLG-3M200R	563M200R	2.00 (.079")	0.05/0.13	3.05	4.95	8.74	10.29	9.53	●	●	●	●
FLG-3M200L	563M200L	2.00 (.079")	0.05/0.13	3.05	4.95	8.74	10.29	9.53	●	●	●	●
FLG-3M220R	563M220R	2.20 (.087")	0.05/0.13	4.57	4.95	8.74	10.29	9.53	●	●	●	●
FLG-3M220L	563M220L	2.20 (.087")	0.05/0.13	4.57	4.95	8.74	10.29	9.53	●	●	●	●
FLG-3M225R	563M225R	2.25 (.089")	0.05/0.13	4.57	4.95	8.74	10.29	9.53	●	●	●	●
FLG-3M225L	563M225L	2.25 (.089")	0.05/0.13	4.57	4.95	8.74	10.29	9.53	●	●	●	●
FLG-3M250R	563M250R	2.50 (.098")	0.05/0.13	4.57	4.95	8.74	10.29	9.53	●	●	●	●
FLG-3M250L	563M250L	2.50 (.098")	0.05/0.13	4.57	4.95	8.74	10.29	9.53	●	●	●	●
FLG-3M275R	563M275R	2.75 (.109")	0.05/0.13	4.57	4.95	8.74	10.29	9.53	●	●	●	●
FLG-3M275L	563M275L	2.75 (.109")	0.05/0.13	4.57	4.95	8.74	10.29	9.53	●	●	●	●
FLG-3M300R	563M300R	3.00 (.118")	0.05/0.13	4.57	4.95	8.74	10.29	9.53	●	●	●	●
FLG-3M300L	563M300L	3.00 (.118")	0.05/0.13	4.57	4.95	8.74	10.29	9.53	●	●	●	●
FLG-3M320R	563M320R	3.20 (.126")	0.05/0.13	4.57	4.95	8.74	10.29	9.53	●	●	●	●
FLG-3M320L	563M320L	3.20 (.126")	0.05/0.13	4.57	4.95	8.74	10.29	9.53	●	●	●	●
FLG-3M325R	563M325R	3.25 (.128")	0.05/0.13	4.57	4.95	8.74	10.29	9.53	●	●	●	●
FLG-3M325L	563M325L	3.25 (.128")	0.05/0.13	4.57	4.95	8.74	10.29	9.53	●	●	●	●
FLG-3M350R	563M350R	3.50 (.138")	0.05/0.13	4.57	4.95	8.74	10.29	9.53	●	●	●	●
FLG-3M350L	563M350L	3.50 (.138")	0.05/0.13	4.57	4.95	8.74	10.29	9.53	●	●	●	●
FLG-3M400R	563M400R	4.00 (.157")	0.25/0.38	4.57	4.95	8.74	10.29	9.53	●	●	●	●
FLG-3M400L	563M400L	4.00 (.157")	0.25/0.38	4.57	4.95	8.74	10.29	9.53	●	●	●	●
FLG-4M320R	564M320R	3.20 (.126")	0.05/0.13	6.35	6.48	11.51	16.15	9.53	●	●	●	●
FLG-4M320L	564M320L	3.20 (.126")	0.05/0.13	6.35	6.48	11.51	16.15	9.53	●	●	●	●

In an effort to improve our stock standard grade offering, there are periodic changes. Please see current price list for up to date grade offering.

- High performance choice in optimal conditions.
- ▲ Recommended grade under general conditions.

Cast Iron	▲			●
Non-Ferrous	▲			●
Stainless/High Temp	▲			●
Steel	▲	▲		●



FLO-LOCK

GROOVING FLG

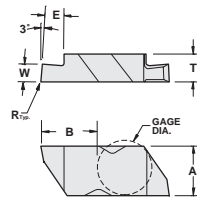

RH Shown



Description	EDP Code	W mm (Inch)	R	E	T	A	B	Gage Dia.	Coating					
									C3	GP3	GP50	AC3	AC50	
FLG-4M300R	564M300R	3.00 (.118)	0.13/0.25	6.35	6.48	11.51	16.15	9.53						
FLG-4M300L	564M300L	3.00 (.118)	0.13/0.25	6.35	6.48	11.51	16.15	9.53						
FLG-4M350R	564M350R	3.20 (.126)	0.51/0.64	6.35	6.48	11.51	16.15	9.53						
FLG-4M350L	564M350L	3.20 (.126)	0.51/0.64	6.35	6.48	11.51	16.15	9.53						
FLG-4M400R	574013R	4.00 (.157)	0.51/0.64	6.35	6.48	11.51	16.15	9.53						
FLG-4M400L	574013L	4.00 (.157)	0.51/0.64	6.35	6.48	11.51	16.15	9.53						
FLG-4M450R	574019R	4.50 (.177)	0.51/0.64	6.35	6.48	11.51	16.15	9.53						
FLG-4M450L	574019L	4.50 (.177)	0.51/0.64	6.35	6.48	11.51	16.15	9.53						
FLG-4M500R	574050R	5.00 (.197)	0.25/0.38	6.35	6.48	11.51	16.15	9.53						
FLG-4M500L	574050L	5.00 (.197)	0.25/0.38	6.35	6.48	11.51	16.15	9.53						
FLG-4M550R	574212R	5.50 (.217)	0.51/0.64	6.35	7.92	11.51	16.15	9.53						
FLG-4M550L	574212L	5.50 (.217)	0.51/0.64	6.35	7.92	11.51	16.15	9.53						
FLG-4M600R	574212R	6.00 (.236)	0.51/0.64	6.35	7.92	11.51	16.15	9.53						
FLG-4M600L	574212L	6.00 (.236)	0.51/0.64	6.35	7.92	11.51	16.15	9.53						

GROOVING FLGP

w/positive rake

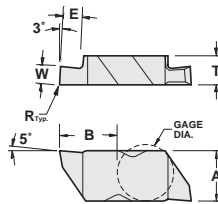

RH Shown

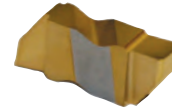

Description	EDP Code	W mm (Inch)	R	E	T	A	B	Dia.	Coating					
									C3	GP3	GP50	AC3	AC50	GPM6
FLGP-2031R	572431R	0.79 (.031)	0.05/0.13	1.27	3.81	5.56	6.86	4.76						
FLGP-2031L	572431L	0.79 (.031)	0.05/0.13	1.27	3.81	5.56	6.86	4.76						
FLGP-2M150R	572M150R	1.50 (.059)	0.13/0.25	2.79	3.81	5.56	6.86	4.76						
FLGP-2M150L	572M150L	1.50 (.059)	0.13/0.25	2.79	3.81	5.56	6.86	4.76						
FLGP-2062R	572462R	1.57 (.062)	0.13/0.25	2.79	3.81	5.56	6.86	4.76						
FLGP-2062L	572462L	1.57 (.062)	0.13/0.25	2.79	3.81	5.56	6.86	4.76						
FLGP-2M200R	572M200R	2.00 (.079)	0.13/0.25	2.79	3.81	5.56	6.86	4.76						
FLGP-2M200L	572M200L	2.00 (.079)	0.13/0.25	2.79	3.81	5.56	6.86	4.76						
FLGP-2125R	572625R	3.18 (.125)	0.13/0.25	2.79	3.81	5.56	6.86	4.76						
FLGP-2125L	572625L	3.18 (.125)	0.13/0.25	2.79	3.81	5.56	6.86	4.76						
FLGP-3088R	573488R	2.24 (.188)	0.13/0.25	4.57	4.95	8.74	10.29	9.53						
FLGP-3088L	573488L	2.24 (.188)	0.13/0.25	4.57	4.95	8.74	10.29	9.53						
FLGP-3125R	573625R	3.18 (.125)	0.13/0.25	4.57	4.95	8.74	10.29	9.53						
FLGP-3125L	573625L	3.18 (.125)	0.13/0.25	4.57	4.95	8.74	10.29	9.53						
FLGP-3156R	573656R	3.96 (.156)	0.13/0.25	4.57	4.95	8.74	10.29	9.53						
FLGP-3156L	573656L	3.96 (.156)	0.13/0.25	4.57	4.95	8.74	10.29	9.53						
FLGP-3189R	573689R	4.80 (.189)	0.51/0.64	4.57	4.95	8.74	10.29	9.53						
FLGP-3189L	573689L	4.80 (.189)	0.51/0.64	4.57	4.95	8.74	10.29	9.53						
FLGP-4189R	574689R	4.80 (.189)	0.51/0.64	6.35	4.95	11.51	16.15	9.53						
FLGP-4189L	574689L	4.80 (.189)	0.51/0.64	6.35	4.95	11.51	16.15	9.53						
FLGP-4250R	574850R	6.35 (.250)	0.51/0.64	6.35	4.95	11.51	16.15	9.53						
FLGP-4250L	574850L	6.35 (.250)	0.51/0.64	6.35	4.95	11.51	16.15	9.53						

In an effort to improve our stock standard grade offering, there are periodic changes. Please see current price list for up to date grade offering.

- High performance choice in optimal conditions.
- ▲ Recommended grade under general conditions.

Material	C3	GP3	GP50	AC3	AC50	GPM6
Cast Iron		▲				
Non-Ferrous		▲				
Stainless/High Temp		▲				
Steel		▲	▲		●	

GROOVING - CHIP-FLO FLR-CB

w/full nose radius

Features:

- Patented chipbreaker
Patent No. 6,146,064
- Maximum chip control
- Industry standard widths

Exclusive patented design!

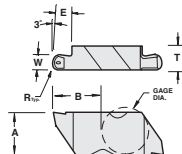

RH Shown

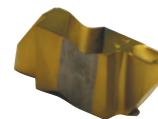

Description	EDP Code	W	R	E	T	A	B	Gage Dia.	Coating					
									C3	GP3	GP50	AC3	AC50	
FLR-3031R-CB	593031PR	1.57 (.062)	0.78	3.18	4.95	8.74	10.24	9.53						
FLR-3031L-CB	593031PL	1.57 (.062)	0.78	3.18	4.95	8.74	10.24	9.53						
FLR-3047R-CB	593047PR	2.39 (.094)	1.19	4.57	4.95	8.74	10.22	9.53						
FLR-3047L-CB	593047PL	2.39 (.094)	1.19	4.57	4.95	8.74	10.22	9.53						
FLR-3062R-CB	593062PR	3.18 (.125)	1.57	4.57	4.95	8.74	10.20	9.53						
FLR-3062L-CB	593062PL	3.18 (.125)	1.57	4.57	4.95	8.74	10.20	9.53						



GROOVING

FLR

w/full nose radius

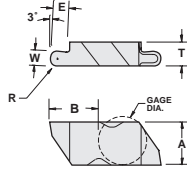

RH Shown

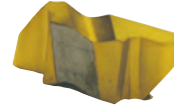

FLO-LOCK

Description	EDP Code	W	R	E	T	A	B	Gage Dia.	Coating				
									C3	GP3	GP50	AC3	AC50
FLR-2M075R	592M075R	1.50 (.059)	0.75	2.79	3.81	5.56	6.81	4.76	●	●	●	●	●
FLR-2M075L	592M075L	1.50 (.059)	0.75	2.79	3.81	5.56	6.81	4.76	●	●	●	●	●
FLR-2031R	592031R	1.58 (.062)	0.79	2.79	3.81	5.56	6.81	4.76	●	●	●	●	●
FLR-2031L	592031L	1.58 (.062)	0.79	2.79	3.81	5.56	6.81	4.76	●	●	●	●	●
FLR-2M100R	592M100R	2.00 (.078)	1.00	2.79	3.81	5.56	6.81	4.76	●	●	●	●	●
FLR-2M100L	592M100L	2.00 (.078)	1.00	2.79	3.81	5.56	6.81	4.76	●	●	●	●	●
FLR-2047R	592047R	2.39 (.094)	1.19	2.79	3.81	5.56	6.79	4.76	●	●	●	●	●
FLR-2047L	592047L	2.39 (.094)	1.19	2.79	3.81	5.56	6.79	4.76	●	●	●	●	●
FLR-2M125R	592M125R	2.50 (.098)	1.25	2.79	3.81	5.56	6.79	4.76	●	●	●	●	●
FLR-2M125L	592M125L	2.50 (.098)	1.25	2.79	3.81	5.56	6.79	4.76	●	●	●	●	●
FLR-2M150R	592M150R	3.00 (.118)	1.50	2.79	3.81	5.56	6.79	4.76	●	●	●	●	●
FLR-2M150L	592M150L	3.00 (.118)	1.50	2.79	3.81	5.56	6.79	4.76	●	●	●	●	●
FLR-2062R	592062R	3.18 (.125)	1.59	2.79	3.81	5.56	6.77	4.76	●	●	●	●	●
FLR-2062L	592062L	3.18 (.125)	1.59	2.79	3.81	5.56	6.77	4.76	●	●	●	●	●
FLR-2M175R	592M175R	3.50 (.138)	1.75	2.79	3.81	5.56	6.77	4.76	●	●	●	●	●
FLR-2M175L	592M175L	3.50 (.138)	1.75	2.79	3.81	5.56	6.77	4.76	●	●	●	●	●
FLR-3031R	593031R	1.58 (.062)	0.79	3.18	4.95	8.74	10.24	9.53	●	●	●	●	●
FLR-3031L	593031L	1.58 (.062)	0.79	3.18	4.95	8.74	10.24	9.53	●	●	●	●	●
FLR-3M100R	593M100R	2.00 (.078)	1.00	3.18	4.95	8.74	10.24	9.53	●	●	●	●	●
FLR-3M100L	593M100L	2.00 (.078)	1.00	3.18	4.95	8.74	10.24	9.53	●	●	●	●	●
FLR-3047R	593047R	2.39 (.094)	1.19	4.57	4.95	8.74	10.22	9.53	●	●	●	●	●
FLR-3047L	593047L	2.39 (.094)	1.19	4.57	4.95	8.74	10.22	9.53	●	●	●	●	●
FLR-3M125R	593M125R	2.50 (.098)	1.25	4.57	4.95	8.74	10.22	9.53	●	●	●	●	●
FLR-3M125L	593M125L	2.50 (.098)	1.25	4.57	4.95	8.74	10.22	9.53	●	●	●	●	●
FLR-3M150R	593M150R	3.00 (.118)	1.50	4.57	4.95	8.74	10.22	9.53	●	●	●	●	●
FLR-3M150L	593M150L	3.00 (.118)	1.50	4.57	4.95	8.74	10.22	9.53	●	●	●	●	●
FLR-3062R	593062R	3.18 (.125)	1.59	4.57	4.95	8.74	10.20	9.53	●	●	●	●	●
FLR-3062L	593062L	3.18 (.125)	1.59	4.57	4.95	8.74	10.20	9.53	●	●	●	●	●
FLR-3M175R	593M175R	3.50 (.138)	1.75	4.57	4.95	8.74	10.20	9.53	●	●	●	●	●
FLR-3M175L	593M175L	3.50 (.138)	1.75	4.57	4.95	8.74	10.20	9.53	●	●	●	●	●
FLR-3078R	593078R	3.96 (.156)	1.98	4.57	4.95	8.74	10.18	9.53	●	●	●	●	●
FLR-3078L	593078L	3.96 (.156)	1.98	4.57	4.95	8.74	10.18	9.53	●	●	●	●	●
FLR-3M200R	593M200R	4.00 (.157)	2.00	4.57	4.95	8.74	10.18	9.53	●	●	●	●	●
FLR-3M200L	593M200L	4.00 (.157)	2.00	4.57	4.95	8.74	10.18	9.53	●	●	●	●	●
FLR-3M225R	593M225R	4.50 (.177)	2.25	4.57	4.95	8.74	10.18	9.53	●	●	●	●	●
FLR-3M225L	593M225L	4.50 (.177)	2.25	4.57	4.95	8.74	10.18	9.53	●	●	●	●	●
FLR-3094R	593094R	4.78 (.188)	2.39	4.57	4.95	8.74	10.16	9.53	●	●	●	●	●
FLR-3094L	593094L	4.78 (.188)	2.39	4.57	4.95	8.74	10.16	9.53	●	●	●	●	●
FLR-4M200R	594M200R	4.00 (.157)	2.00	6.35	6.48	11.51	16.07	9.53	●	●	●	●	●
FLR-4M200L	594M200L	4.00 (.157)	2.00	6.35	6.48	11.51	16.07	9.53	●	●	●	●	●
FLR-4M225R	594M225R	4.50 (.177)	2.25	6.35	6.48	11.51	16.07	9.53	●	●	●	●	●
FLR-4M225L	594M225L	4.50 (.177)	2.25	6.35	6.48	11.51	16.07	9.53	●	●	●	●	●
FLR-4094R	594094R	4.78 (.188)	2.39	6.35	6.48	11.51	16.03	9.53	●	●	●	●	●
FLR-4094L	594094L	4.78 (.188)	2.39	6.35	6.48	11.51	16.03	9.53	●	●	●	●	●
FLR-4M250R	594M250R	5.00 (.197)	2.50	6.35	6.48	11.51	16.03	9.53	●	●	●	●	●
FLR-4M250L	594M250L	5.00 (.197)	2.50	6.35	6.48	11.51	16.03	9.53	●	●	●	●	●
FLR-4125R	594225R	6.35 (.250)	3.18	6.35	6.48	11.51	15.98	9.53	●	●	●	●	●
FLR-4125L	594225L	6.35 (.250)	3.18	6.35	6.48	11.51	15.98	9.53	●	●	●	●	●

In an effort to improve our stock standard grade offering, there are periodic changes. Please see current price list for up to date grade offering.

- High performance choice in optimal conditions.
- ▲ Recommended grade under general conditions.

	Cast Iron	Non-Ferrous	Stainless/High Temp	Steel
▲	●	●	●	●
▲	●	●	●	●
▲	●	●	●	●
▲	●	●	●	●



FLO-LOCK

GROOVING

FLRP

w/full nose radius and positive rake

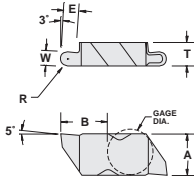

RH Shown

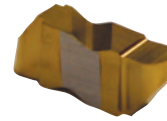

Description	EDP Code	W	R	E	T	A	B	Gage Dia.	Coating					
									Uncoated	TIN Coated	A/TIN Coated	C3	GP3	GP50
FLRP-2031R	592831R	1.57 (.062)	0.79	2.79	3.81	5.56	6.81	4.76	●	●	●	●	●	●
FLRP-2031L	592831L	1.57 (.062)	0.79	2.79	3.81	5.56	6.81	4.76	●	●	●	●	●	●
FLRP-2M150R	592M150R	3.00 (.118)	1.50	2.79	3.81	5.56	6.81	4.76	●	●	●	●	●	●
FLRP-2M150L	592M150L	3.00 (.118)	1.50	2.79	3.81	5.56	6.81	4.76	●	●	●	●	●	●
FLRP-2062R	592831R	3.18 (.125)	1.57	2.79	3.81	5.56	6.81	4.76	●	●	●	●	●	●
FLRP-2062L	592831L	3.18 (.125)	1.57	2.79	3.81	5.56	6.81	4.76	●	●	●	●	●	●
FLRP-2125R	602025R	6.35 (.250)	3.18	2.79	3.81	5.56	6.81	4.76	●	●	●	●	●	●
FLRP-2125L	602025L	6.35 (.250)	3.18	2.79	3.81	5.56	6.81	4.76	●	●	●	●	●	●
FLRP-3031R	593831R	1.57 (.062)	0.79	0.79	4.95	8.74	10.24	9.53	●	●	●	●	●	●
FLRP-3031L	593831L	1.57 (.062)	0.79	0.79	4.95	8.74	10.24	9.53	●	●	●	●	●	●
FLRP-3047R	593847R	2.39 (.094)	1.19	4.57	4.95	8.74	10.22	9.53	●	●	●	●	●	●
FLRP-3047L	593847L	2.39 (.094)	1.19	4.57	4.95	8.74	10.22	9.53	●	●	●	●	●	●
FLRP-3062R	593862R	3.18 (.125)	1.57	4.57	4.95	8.74	10.20	9.53	●	●	●	●	●	●
FLRP-3062L	593862L	3.18 (.125)	1.57	4.57	4.95	8.74	10.20	9.53	●	●	●	●	●	●
FLRP-3078R	593878R	3.96 (.156)	1.98	4.57	4.95	8.74	10.18	9.53	●	●	●	●	●	●
FLRP-3078L	593878L	3.96 (.156)	1.98	4.57	4.95	8.74	10.18	9.53	●	●	●	●	●	●
FLRP-3088R	593888R	4.40 (.176)	2.24	4.57	4.95	8.74	10.16	9.53	●	●	●	●	●	●
FLRP-3088L	593888L	4.40 (.176)	2.24	4.57	4.95	8.74	10.16	9.53	●	●	●	●	●	●
FLRP-3094R	593894R	4.80 (.188)	2.39	4.57	4.95	8.74	10.16	9.53	●	●	●	●	●	●
FLRP-3094L	593894L	4.80 (.188)	2.39	4.57	4.95	8.74	10.16	9.53	●	●	●	●	●	●
FLRP-3125R	603025R	6.35 (.250)	3.18	4.57	4.95	8.74	10.16	9.53	●	●	●	●	●	●
FLRP-3125L	603025L	6.35 (.250)	3.18	4.57	4.95	8.74	10.16	9.53	●	●	●	●	●	●
FLRP-3156R	603056R	7.92 (.312)	3.96	4.57	4.95	8.74	10.16	9.53	●	●	●	●	●	●
FLRP-3156L	603056L	7.92 (.312)	3.96	4.57	4.95	8.74	10.16	9.53	●	●	●	●	●	●
FLRP-3189R	603089R	9.60 (.378)	4.80	4.57	4.95	8.74	10.16	9.53	●	●	●	●	●	●
FLRP-3189L	603089L	9.60 (.378)	4.80	4.57	4.95	8.74	10.16	9.53	●	●	●	●	●	●
FLRP-4062R	594862R	3.18 (.125)	1.57	6.35	6.48	11.51	16.07	9.53	●	●	●	●	●	●
FLRP-4062L	594862L	3.18 (.125)	1.57	6.35	6.48	11.51	16.07	9.53	●	●	●	●	●	●
FLRP-4094R	594894R	4.80 (.188)	2.39	6.35	6.48	11.51	16.03	9.53	●	●	●	●	●	●
FLRP-4094L	594894L	4.80 (.188)	2.39	6.35	6.48	11.51	16.03	9.53	●	●	●	●	●	●
FLRP-4125R	604025R	6.35 (.250)	3.18	6.35	6.48	11.51	15.98	9.53	●	●	●	●	●	●
FLRP-4125L	604025L	6.35 (.250)	3.18	6.35	6.48	11.51	15.98	9.53	●	●	●	●	●	●
FLRP-4189R	604089R	9.60 (.378)	4.80	6.35	6.48	11.51	15.98	9.53	●	●	●	●	●	●
FLRP-4189L	604089L	9.60 (.378)	4.80	6.35	6.48	11.51	15.98	9.53	●	●	●	●	●	●
FLRP-4250R	604225R	12.70 (.500)	6.35	6.35	6.48	11.51	15.98	9.53	●	●	●	●	●	●
FLRP-4250L	604225L	12.70 (.500)	6.35	6.35	6.48	11.51	15.98	9.53	●	●	●	●	●	●

FLO-LOCK

FACE GROOVING - CHIP-FLO

FLF-CB

Exclusive patented design!

Features:

- Patented chipbreaker - Patent No. 6,146,064
- Maximum chip control
- Industry standard widths

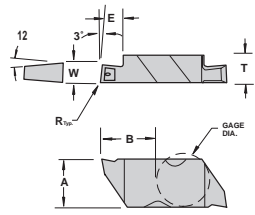

RH Shown

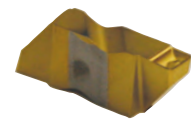

Description	EDP Code	W	R	E	T	A	B	Gage Dia.	Coating					
									Uncoated	TIN Coated	A/TIN Coated	C3	GP3	GP50
FLF-3M200R-CB	553M200PR	2.00 (.078)	0.13/0.25	3.31	4.95	8.74	10.29	9.53	●	●	●	●	●	●
FLF-3M200L-CB	553M200PL	2.00	0.13/0.25	3.31	4.95	8.74	10.29	9.53	●	●	●	●	●	●
FLF-3M300R-CB	553M300PR	3.00	0.13/0.25	4.57	4.95	8.74	10.29	9.53	●	●	●	●	●	●
FLF-3M300L-CB	553M300PL	3.00	0.13/0.25	4.57	4.95	8.74	10.29	9.53	●	●	●	●	●	●
FLF-3125R-CB	563025PR	3.18 (.125)	0.13/0.25	4.57	4.95	8.74	10.29	9.53	●	●	●	●	●	●
FLF-3125L-CB	563025PL	3.18 (.125)	0.13/0.25	4.57	4.95	8.74	10.29	9.53	●	●	●	●	●	●
FLF-3156R-CB	563056PR	3.96 (.156)	0.13/0.25	4.57	4.95	8.74	10.29	9.53	●	●	●	●	●	●
FLF-3156L-CB	563056PL	3.96 (.156)	0.13/0.25	4.57	4.95	8.74	10.29	9.53	●	●	●	●	●	●
FLF-3188R-CB	563088PR	4.77 (.188)	0.51/0.64	4.57	4.95	8.74	10.29	9.53	●	●	●	●	●	●
FLF-3188L-CB	563088PL	4.77 (.188)	0.51/0.64	4.57	4.95	8.74	10.29	9.53	●	●	●	●	●	●

In an effort to improve our stock standard grade offering, there are periodic changes. Please see current price list for up to date grade offering.

● High performance choice in optimal conditions.
▲ Recommended grade under general conditions.

Material	C3	GP3	GP50	AC3	AC50
Cast Iron		▲	●	●	●
Non-Ferrous		▲	●	●	●
Stainless/High Temp		▲	●	●	●
Steel			▲	●	●



FACE GROOVING

FLF

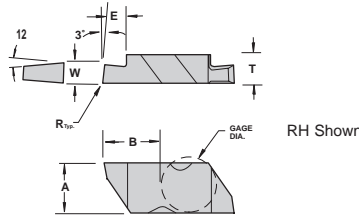

Description	EDP Code	W	R	E	T	A	B	Gage Dia.	Coating				
									C3	GP3	GP50	AC3	AC50
FLF-3125R	563025R	3,18 (.125)	0.13/0.25	4.57	4.95	8.74	10.29	9.53	●	●	●	●	●
FLF-3125L	563025L	3,18 (.125)	0.13/0.25	4.57	4.95	8.74	10.29	9.53	●	●	●	●	●
FLF-3156R	563056R	3,96 (.156)	0.13/0.25	4.57	4.95	8.74	10.29	9.53	●	●	●	●	●
FLF-3156L	563025L	3,96 (.156)	0.13/0.25	4.57	4.95	8.74	10.29	9.53	●	●	●	●	●
FLF-3188R	563088R	4,77 (.188)	0.51/0.64	4.57	4.95	8.74	10.29	9.53	●	●	●	●	●
FLF-3188L	563088L	4,77 (.188)	0.51/0.64	4.57	4.95	8.74	10.29	9.53	●	●	●	●	●
FLF-4250R	564250R	6,35 (.250)	0.51/0.64	6.35	6.48	11.51	16.15	9.53	●	●	●	●	●
FLF-4250L	564250L	6,35 (.250)	0.51/0.64	6.35	6.48	11.51	16.15	9.53	●	●	●	●	●
FLF-6218R	566218R	5,54 (.218)	0.76/0.89	6.35	9.73	11.51	16.15	9.53	●	●	●	●	●
FLF-6218L	566218L	5,54 (.218)	0.76/0.89	6.35	9.73	11.51	16.15	9.53	●	●	●	●	●
FLF-6250R	566250R	6,35 (.250)	0.76/0.89	6.35	9.73	11.51	16.15	9.53	●	●	●	●	●
FLF-6250L	566250L	6,35 (.250)	0.76/0.89	6.35	9.73	11.51	16.15	9.53	●	●	●	●	●
FLF-6375R	566475R	9,53 (.375)	0.76/0.89	6.35	9.73	11.51	16.15	9.53	●	●	●	●	●
FLF-6375L	566475L	9,53 (.375)	0.76/0.89	6.35	9.73	11.51	16.15	9.53	●	●	●	●	●

FLO-LOCK

DEEP GROOVING - CHIP-FLO

FLGD-CB

Single ended

Exclusive patented design!

Features:

- Patented chipbreaker - Patent No. 6,146,064
- Maximum chip control
- Industry standard widths

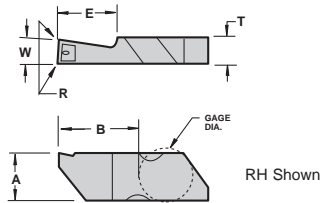

Description	EDP Code	W	R	E	T	A	B	Gage Dia.	Coating				
									C3	GP3	GP50	AC3	AC50
FLGD-3062R-CB*	6335062PR	1.58 (.062)	0.13/0.25	3.68	4.95	8.74	12.83	9.53	●	●	●	●	●
FLGD-3062L-CB*	6335062PL	1.58 (.062)	0.13/0.25	3.68	4.95	8.74	12.83	9.53	●	●	●	●	●
FLGD-3M200R-CB*	6335M200PR	2.00	0.13/0.25	3.68	4.95	8.74	12.83	9.53	●	●	●	●	●
FLGD-3M200L-CB*	6335M200PL	2.00	0.13/0.25	3.68	4.95	8.74	12.83	9.53	●	●	●	●	●
FLGD-3094R-CB	6335094PR	2.39 (.094)	0.13/0.25	6.35	4.95	8.74	12.83	9.53	●	●	●	●	●
FLGD-3094L-CB	6335094PL	2.39 (.094)	0.13/0.25	6.35	4.95	8.74	12.83	9.53	●	●	●	●	●
FLGD-3M250R-CB	6335M250PR	2.50	0.13/0.25	6.35	4.95	8.74	12.83	9.53	●	●	●	●	●
FLGD-3M250L-CB	6335M250PL	2.50	0.13/0.25	6.35	4.95	8.74	12.83	9.53	●	●	●	●	●
FLGD-3M300R-CB	6335M300PR	3.00	0.13/0.25	6.35	4.95	8.74	12.83	9.53	●	●	●	●	●
FLGD-3M300L-CB	6335M300PL	3.00	0.13/0.25	6.35	4.95	8.74	12.83	9.53	●	●	●	●	●
FLGD-3125R-CB	6335125PR	3.18 (.125)	0.13/0.25	6.35	4.95	8.74	12.83	9.53	●	●	●	●	●
FLGD-3125L-CB	6335125PL	3.18 (.125)	0.13/0.25	6.35	4.95	8.74	12.83	9.53	●	●	●	●	●
FLGD-3M350R-CB	6335M350PR	3.50	0.13/0.25	6.35	4.95	8.74	12.83	9.53	●	●	●	●	●
FLGD-3M350L-CB	6335M350PL	3.50	0.13/0.25	6.35	4.95	8.74	12.83	9.53	●	●	●	●	●
FLGD-3M400R-CB	6335M400PR	4.00	0.13/0.25	6.35	4.95	8.74	12.83	9.53	●	●	●	●	●
FLGD-3M400L-CB	6335M400PL	4.00	0.13/0.25	6.35	4.95	8.74	12.83	9.53	●	●	●	●	●
FLGD-3189R-CB	6335189PR	4.80 (.189)	0.51/0.64	6.35	4.95	8.74	12.83	9.53	●	●	●	●	●
FLGD-3189L-CB	6335189PL	4.80 (.189)	0.51/0.64	6.35	4.95	8.74	12.83	9.53	●	●	●	●	●
FLGD-4125R-CB	6345125PR	3.18 (.125)	0.51/0.64	9.53	6.48	11.51	19.33	9.53	●	●	●	●	●
FLGD-4125L-CB	6345125PL	3.18 (.125)	0.51/0.64	9.53	6.48	11.51	19.33	9.53	●	●	●	●	●
FLGD-4M400R-CB	6345M400PR	4.00	0.51/0.64	9.53	6.48	11.51	19.33	9.53	●	●	●	●	●
FLGD-4M400L-CB	6345M400PL	4.00	0.51/0.64	9.53	6.48	11.51	19.33	9.53	●	●	●	●	●
FLGD-4M450R-CB	6345M450PR	4.50	0.51/0.64	12.70	6.48	11.51	19.33	9.53	●	●	●	●	●
FLGD-4M450L-CB	6345M450PL	4.50	0.51/0.64	12.70	6.48	11.51	19.33	9.53	●	●	●	●	●
FLGD-4189R-CB	6345189PR	4.80 (.189)	0.51/0.64	9.53	6.48	11.51	19.33	9.53	●	●	●	●	●
FLGD-4189L-CB	6345189PL	4.80 (.189)	0.51/0.64	9.53	6.48	11.51	19.33	9.53	●	●	●	●	●
FLGD-4M500R-CB	6345M500PR	5.00	0.51/0.64	12.70	6.48	11.51	19.33	9.53	●	●	●	●	●
FLGD-4M500L-CB	6345M500PL	5.00	0.51/0.64	12.70	6.48	11.51	19.33	9.53	●	●	●	●	●
FLGD-4M550R-CB	6345M550PR	5.50	0.51/0.64	12.70	6.48	11.51	22.50	9.53	●	●	●	●	●
FLGD-4M550L-CB	6345M550PL	5.50	0.51/0.64	12.70	6.48	11.51	22.50	9.53	●	●	●	●	●
FLGD-4250R-CB	6345250PR	6.35 (.250)	0.51/0.64	12.70	6.48	11.51	22.50	9.53	●	●	●	●	●
FLGD-4250L-CB	6345250PL	6.35 (.250)	0.51/0.64	12.70	6.48	11.51	22.50	9.53	●	●	●	●	●

*Inserts are double ended.

In an effort to improve our stock standard grade offering, there are periodic changes. Please see current price list for up to date grade offering.

- High performance choice in optimal conditions.
- ▲ Recommended grade under general conditions.

Material	▲	●
Cast Iron	▲	●
Non-Ferrous	▲	●
Stainless/High Temp	▲	●
Steel	▲	●



FLO-LOCK

DEEP GROOVING

FLGD

Single ended

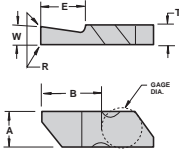

RH Shown

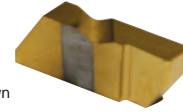

Description	EDP Code	W	R	E	T	A	B	Gage Dia.	Coatings				
									C3	GP3	GP50	AC3	AC50
FLGD-3M200R*	6334M200R	2.00	0.13/0.25	3.68	4.95	8.74	12.83	9.53	●	●	●	●	●
FLGD-3M200L*	6334M200L	2.00	0.13/0.25	3.68	4.95	8.74	12.83	9.53	●	●	●	●	●
FLGD-3M250R	6334M250R	2.50	0.13/0.25	6.35	4.95	8.74	12.83	9.53	●	●	●	●	●
FLGD-3M250L	6334M250L	2.50	0.13/0.25	6.35	4.95	8.74	12.83	9.53	●	●	●	●	●
FLGD-3M300R	6334M300R	3.00	0.13/0.25	6.35	4.95	8.74	12.83	9.53	●	●	●	●	●
FLGD-3M300L	6334M300L	3.00	0.13/0.25	6.35	4.95	8.74	12.83	9.53	●	●	●	●	●
FLGD-3M400R	6334M400R	4.00	0.51/0.64	6.35	4.95	8.74	12.83	9.53	●	●	●	●	●
FLGD-3M400L	6334M400L	4.00	0.51/0.64	6.35	4.95	8.74	12.83	9.53	●	●	●	●	●
FLGD-4M400R*	6344M400R	4.00	0.13/0.25	7.36	6.48	11.51	16.15	9.53	●	●	●	●	●
FLGD-4M400L*	6344M400L	4.00	0.13/0.25	7.36	6.48	11.51	16.15	9.53	●	●	●	●	●
FLGD-4M450R	6344M450R	4.50	0.51/0.64	9.53	6.48	11.51	19.33	9.53	●	●	●	●	●
FLGD-4M450L	6344M450L	4.50	0.51/0.64	9.53	6.48	11.51	19.33	9.53	●	●	●	●	●
FLGD-4M500R	6344M500R	5.00	0.51/0.64	12.70	6.48	11.51	22.50	9.53	●	●	●	●	●
FLGD-4M500L	6344M500L	5.00	0.51/0.64	12.70	6.48	11.51	22.50	9.53	●	●	●	●	●

*Inserts are double ended.

DEEP GROOVING - FNR

FLRD

Full nose radius - Single ended

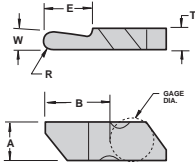

RH Shown

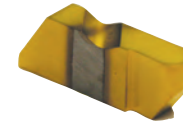

Description	EDP Code	W	R	E	T	A	B	Gage Dia.	Coatings				
									C3	GP3	GP50	AC3	AC50
FLRD-3031R*	6336031R	1.57 (.031)	0.79	3.18	4.95	8.74	10.24	9.53	●	●	●	●	●
FLRD-3031L*	6336031L	1.57 (.031)	0.79	3.18	4.95	8.74	10.24	9.53	●	●	●	●	●
FLRD-3062R	6336062R	3.19 (.062)	1.57	6.35	4.95	8.74	12.74	9.53	●	●	●	●	●
FLRD-3062L	6336062L	3.19 (.062)	1.57	6.35	4.95	8.74	12.74	9.53	●	●	●	●	●
FLRD-3094R	6336094R	4.80 (.094)	2.39	6.35	4.95	8.74	12.74	9.53	●	●	●	●	●
FLRD-3094L	6336094L	4.80 (.094)	2.39	6.35	4.95	8.74	12.74	9.53	●	●	●	●	●
FLRD-4094R	6346094R	4.80 (.094)	2.39	12.70	6.48	11.51	22.50	9.53	●	●	●	●	●
FLRD-4094L	6346094L	4.80 (.094)	2.39	12.70	6.48	11.51	22.50	9.53	●	●	●	●	●
FLRD-4125R	6346125R	6.35 (.125)	3.18	12.70	6.48	11.51	22.50	9.53	●	●	●	●	●
FLRD-4125L	6346125L	6.35 (.125)	3.18	12.70	6.48	11.51	22.50	9.53	●	●	●	●	●

*Inserts are double ended.

INTERNAL DEEP FACE GROOVING - CHIP-FLO

FLFD-I-CB

Single ended

Exclusive patented design!

Features:

- Patented chipbreaker
Patent No. 6,146,064
- Maximum chip control
- Industry standard widths

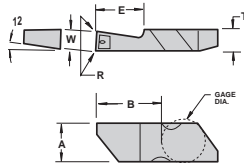

RH Shown

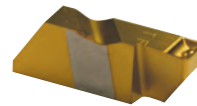

Description	EDP Code	W	R	E	T	A	B	Gage Dia.	Coatings				
									C3	GP3	GP50	AC3	AC50
FLFD-3M300R-I-CB	633M300PRI	3.00	0.13/0.25	6.35	4.95	8.74	12.83	9.53	●	●	●	●	●
FLFD-3M300L-I-CB	633M300PLI	3.00	0.13/0.25	6.35	4.95	8.74	12.83	9.53	●	●	●	●	●
FLFD-3125R-I-CB	6338125PRI	3.18 (.125)	0.13/0.25	6.35	4.95	8.74	12.83	9.53	●	●	●	●	●
FLFD-3125L-I-CB	6338125PLI	3.18 (.125)	0.13/0.25	6.35	4.95	8.74	12.83	9.53	●	●	●	●	●
FLFD-3189R-I-CB	6338189PRI	4.80 (.189)	0.51/0.64	6.35	4.95	8.74	12.83	9.53	●	●	●	●	●
FLFD-3189L-I-CB	6338189PLI	4.80 (.189)	0.51/0.64	6.35	4.95	8.74	12.83	9.53	●	●	●	●	●

DEEP FACE GROOVING

CHIP-FLO

FLFD-CB

Single ended

Exclusive patented design!

Features:

- Patented chipbreaker
Patent No. 6,146,064
- Maximum chip control
- Industry standard widths

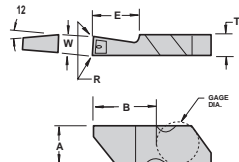

RH Shown

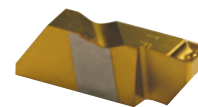

Description	EDP Code	W	R	E	T	A	B	Gage Dia.	Coatings				
									C3	GP3	GP50	AC3	AC50
FLFD-3125R-CB	6338125PR	3,18 (.125)	0.13/0.25	6.35	4.95	8.74	12.83	9.53	●	●	●	●	●
FLFD-3125L-CB	6338125PL	3,18 (.125)	0.13/0.25	6.35	4.95	8.74	12.83	9.53	●	●	●	●	●
FLFD-3189R-CB	6338189PR	4,80 (.189)	0.51/0.64	6.35	4.95	8.74	12.83	9.53	●	●	●	●	●
FLFD-3189L-CB	6338189PL	4,80 (.189)	0.51/0.64	6.35	4.95	8.74	12.83	9.53	●	●	●	●	●

In an effort to improve our stock standard grade offering, there are periodic changes. Please see current price list for up to date grade offering.

- High performance choice in optimal conditions.
- ▲ Recommended grade under general conditions.

Material	C3	GP3	GP50	AC3	AC50
Cast Iron		▲			●
Non-Ferrous		▲			●
Stainless/High Temp		▲			●
Steel			▲		●



DEEP GROOVING

FLGT

Double ended

Exclusive 2 edge design!

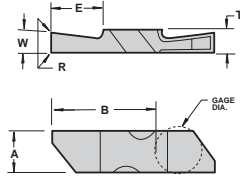

RH Shown

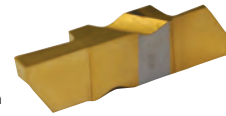

	Uncoated	TIN Coated	AlTiN Coated
--	----------	------------	--------------

Fits FLSLT/RT Holders. See page 103

Description	EDP Code	W	R	E	T	A	B	Gage Dia.					
									C3	GP3	GP50	AC3	AC50
FLGT-3094R	6332094R	2,39 (.094)	0.13/0.25	6.99	4.95	8.74	21.72	9.53	●	●	●	●	●
FLGT-3094L	6332094L	2,39 (.094)	0.13/0.25	6.99	4.95	8.74	21.72	9.53	●	●	●	●	●
FLGT-3125R	6332125R	3,18 (.125)	0.13/0.25	11.10	4.95	8.74	21.72	9.53	●	●	●	●	●
FLGT-3125L	6332125L	3,18 (.125)	0.13/0.25	11.10	4.95	8.74	21.72	9.53	●	●	●	●	●
FLGT-330R	633230R	3,00	0.13/0.25	11.10	4.95	8.74	21.72	9.53	●	●	●	●	●
FLGT-330L	633230L	3,00	0.13/0.25	11.10	4.95	8.74	21.72	9.53	●	●	●	●	●
FLGT-340R	633240R	4,00	0.13/0.25	11.10	4.95	8.74	21.72	9.53	●	●	●	●	●
FLGT-340L	633240L	4,00	0.13/0.25	11.10	4.95	8.74	21.72	9.53	●	●	●	●	●
FLGT-3189R	6332189R	4,80 (.189)	0.51/0.64	11.10	4.95	8.74	21.72	9.53	●	●	●	●	●
FLGT-3189L	6332189L	4,80 (.189)	0.51/0.64	11.10	4.95	8.74	21.72	9.53	●	●	●	●	●
FLGT-4125R	6342125R	3,18 (.125)	0.13/0.25	13.97	6.48	11.51	28.85	9.53	●	●	●	●	●
FLGT-4125L	6342125L	3,18 (.125)	0.13/0.25	13.97	6.48	11.51	28.85	9.53	●	●	●	●	●
FLGT-4189R	6342189R	4,80 (.189)	0.51/0.64	13.97	6.48	11.51	28.85	9.53	●	●	●	●	●
FLGT-4189L	6342189L	4,80 (.189)	0.51/0.64	13.97	6.48	11.51	28.85	9.53	●	●	●	●	●
FLGT-450R	6344450R	5,00	0.13/0.25	13.97	6.48	11.51	28.85	9.53	●	●	●	●	●
FLGT-450L	6344450L	5,00	0.13/0.25	13.97	6.48	11.51	28.85	9.53	●	●	●	●	●
FLGT-460R	6344460R	6,00	0.13/0.25	13.97	6.48	11.51	28.85	9.53	●	●	●	●	●
FLGT-460L	6344460L	6,00	0.13/0.25	13.97	6.48	11.51	28.85	9.53	●	●	●	●	●
FLGT-4250R	6342250R	6,35 (.250)	0.51/0.64	13.97	6.48	11.51	28.85	9.53	●	●	●	●	●
FLGT-4250L	6342250L	6,35 (.250)	0.51/0.64	13.97	6.48	11.51	28.85	9.53	●	●	●	●	●

FLO-LOCK

DEEP FACE GROOVING

FLFT

Double ended

Exclusive 2 edge design!

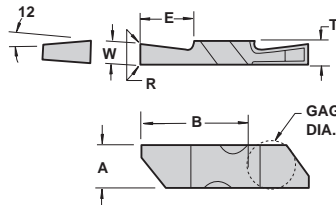

RH Shown

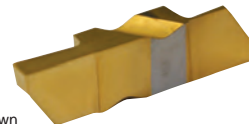

	Uncoated	TIN Coated	AlTiN Coated
--	----------	------------	--------------

Fits FLSLT/RT Holders. See page 103

Description	EDP Code	W	R	E	T	A	B	Gage Dia.					
									C3	GP3	GP50	AC3	AC50
FLFT-3M300R	6339M300R	3.00	0.13/0.25	9.53	4.95	8.74	22.48	9.53	●	●	●	●	●
FLFT-3M300L	6339M300L	3.00	0.13/0.25	9.53	4.95	8.74	22.48	9.53	●	●	●	●	●
FLFT-3125R	6339125R	3,18 (.125)	0.13/0.25	9.53	4.95	8.74	22.48	9.53	●	●	●	●	●
FLFT-3125L	6339125L	3,18 (.125)	0.13/0.25	9.53	4.95	8.74	22.48	9.53	●	●	●	●	●
FLFT-4189R	6349189R	4,80 (.189)	0.51/0.64	13.97	6.48	11.51	28.85	9.53	●	●	●	●	●
FLFT-4189L	6349189L	4,80 (.189)	0.51/0.64	13.97	6.48	11.51	28.85	9.53	●	●	●	●	●
FLFT-4250R	6349250R	6,35 (.250)	0.51/0.64	13.97	6.48	11.51	28.85	9.53	●	●	●	●	●
FLFT-4250L	6349250L	6,35 (.250)	0.51/0.64	13.97	6.48	11.51	28.85	9.53	●	●	●	●	●

DEEP GROOVING - FNR

FLRT

Double ended

Exclusive 2 edge design!

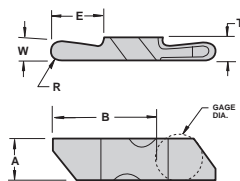

RH Shown



	Uncoated	TIN Coated	AlTiN Coated
--	----------	------------	--------------

Fits FLSLT/RT Holders. See page 103

Description	EDP Code	W	R	E	T	A	B	Gage Dia.					
									C3	GP3	GP50	AC3	AC50
FLRT-3062R	6337062R	3,18 (.062)	1.57	11.10	4.95	8.74	21.72	9.53		▲		●	
FLRT-3062L	6337062L	3,18 (.062)	1.57	11.10	4.95	8.74	21.72	9.53		▲		●	
FLRT-3094R	6337094R	4,80 (.094)	2.39	11.10	4.95	8.74	21.72	9.53		▲		●	
FLRT-3094L	6337094L	4,80 (.094)	2.39	11.10	4.95	8.74	21.72	9.53		▲		●	
FLRT-4062R	6347062R	3,18 (.062)	1.57	13.97	6.48	11.51	28.85	9.53		▲		●	
FLRT-4062L	6347062L	3,18 (.062)	1.57	13.97	6.48	11.51	28.85	9.53		▲		●	
FLRT-4094R	6347094R	4,80 (.094)	2.39	13.97	6.48	11.51	28.85	9.53		▲		●	
FLRT-4094L	6347094L	4,80 (.094)	2.39	13.97	6.48	11.51	28.85	9.53		▲		●	
FLRT-4125R	6347125R	6,35 (.125)	3.18	13.97	6.48	11.51	28.85	9.53		▲		●	
FLRT-4125L	6347125L	6,35 (.125)	3.18	13.97	6.48	11.51	28.85	9.53		▲		●	

In an effort to improve our stock standard grade offering, there are periodic changes. Please see current price list for up to date grade offering.

● High performance choice in optimal conditions.
▲ Recommended grade under general conditions.

Cast Iron		▲		●
Non-Ferrous		▲		●
Stainless/High Temp		▲		●
Steel			▲	●



Recommended Feed rate - mm/rev

Workpiece Group	Insert Rake Configuration	
	FLG-Neutral	FLG-CB
Free Machining Carbon Steels	0.11 - 0.25	0.13 - 0.36
Plain Carbon Steels	0.11 - 0.25	0.13 - 0.36
Alloy Steels 190-330 HB	0.11 - 0.25	0.13 - 0.36
Alloy Steels 330-450 HB	0.08 - 0.23	0.13 - 0.30
Martensitic/Ferritic Stainless Steel 400 Series	0.11 - 0.25	0.13 - 0.36
Austenitic Stainless 300 Series	0.08 - 0.15	0.10 - 0.20
Gray Cast Iron 190-330 HB	0.11 - 0.25	---
Gray Cast Iron 330-450 HB	0.08 - 0.23	---
Alloy / Ductile Irons	0.11 - 0.25	0.13 - 0.36
Free Machining Aluminum Alloys	0.13 - 0.12	0.15 - 0.41
High-Silicon Aluminum Alloys	0.08 - 0.15	---
Copper / Zinc / Brass	0.13 - 0.30	0.15 - 0.41
Non-Metallics	0.13 - 0.30	---
High Temperature Alloys 200-260 HB	0.08 - 0.15	0.10 - 0.18
High Temperature Alloys 260-450 HB	0.08 - 0.15	0.10 - 0.18
Titanium Alloys (Ti 6Al-4V)	0.08 - 0.15	0.10 - 0.20
Hardened Materials 48-65 HRC	0.04 - 0.13	---

Internal Grooving limitations

Insert	internal grooving limitations	
	maximum groove depth (mm)	minimum bore diameter (mm)
FLG-2031R/L	1.27	18.54
FLG-2041R/L	1.27	18.54
FLG-2047R/L	1.27	18.54
FLG-2058R/L	1.27	18.54
FLG-2062R/L	2.59	44.45
FLG-2094R/L	2.49	38.10
FLG-2125R/L	2.03	25.40
FLG-3047R/L	2.39	44.45
FLG-3062R/L	2.39	44.45
FLG-3072R/L	2.29	41.28
FLG-3078R/L	1.91	34.93
FLG-3088R/L	1.91	34.93
FLG-3094R/L	3.81	60.33
FLG-3097R/L	3.81	60.33
FLG-3105R/L	3.81	60.33
FLG-3110R/L	3.68	53.98
FLG-3122R/L	3.68	53.98
FLG-3125R/L	3.51	47.63
FLG-3142R/L	3.51	47.63
FLG-3156R/L	3.18	41.28
FLG-3178R/L	3.18	41.28
FLG-3185R/L	2.79	34.93
FLG-3189R/L	2.79	34.93
FLG-4125R/L	3.81	69.85
FLG-4189R/L	6.22	127.00
FLG-4213R/L	6.10	114.30
FLG-4219R/L	5.54	82.55
FLG-4250R/L	5.08	63.50
FLG-5250R/L	9.17	15.81
FLG-5281R/L	8.74	10.81
FLG-5312R/L	8.31	18.54
FLG-5344R/L	7.47	18.54
FLG-5375R/L	6.53	44.45
FLG-6250R/L	6.35	38.10
FLG-6281R/L	6.22	25.40
FLG-6312R/L	6.10	38.10
FLG-6344R/L	5.54	38.10
FLG-6375R/L	5.08	41.28

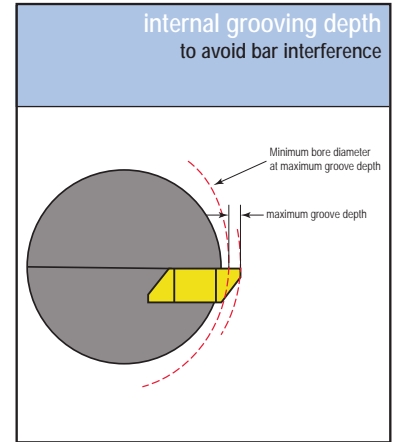

NOTE: Internal grooving depth limits are a function of bar clearance versus bore diameter.

*The same maximum groove depth and minimum bore diameter values also apply to the FLG-CB and FLR (Full radius) inserts of the same size and groove width.

FLO-LOCK

Recommended SFM for Grooving Applications

Workpiece Group	Uncoated	TiN PVD Coated				AlTiN PVD Coated			TiN Cermet	CBN		PCD
	C3	GP22	GP3	GP4	GP50	AC22	AC3	AC50	GPM6	CB200	CB400	PC33
Free Machining Carbon Steels	---	45.72-91.44	60.96-121.92	18.29-53.34	60.96-182.88	60.96-121.92	76.20-137.16	121.92-243.84	182.88-457.20	---	---	---
Plain Carbon Steels	---	45.72-91.44	60.96-121.92	18.29-53.34	60.96-182.88	60.96-121.92	76.20-137.16	137.16-243.84	182.88-365.76	---	---	---
Alloy Steels 190-330 HB	---	45.72-91.44	60.96-121.92	18.29-45.72	60.96-152.40	60.96-106.68	76.20-121.92	121.92-243.84	152.40-335.28	---	---	---
Alloy Steels 330-450 HB	---	45.72-91.44	60.96-106.68	18.29-45.72	60.96-137.16	60.96-106.68	76.20-121.92	121.92-228.60	182.88-243.84	---	---	---
Martensitic/Ferritic Stainless Steel 400 Series	---	45.72-91.44	60.96-121.92	18.29-45.72	60.96-152.40	60.96-121.92	76.20-137.16	106.68-213.36	152.40-243.84	---	---	---
Austenitic Stainless 300 Series	60.96-121.92	45.72-121.92	60.96-152.40	18.29-45.72	---	91.44-182.88	76.20-213.36	---	152.40-304.80	---	---	---
Gray Cast Iron 190-330 HB	30.48-114.30	45.72-121.92	60.96-182.88	18.29-45.72	---	91.44-182.88	76.20-213.36	---	121.92-335.28	426.72-762.00	---	---
Gray Cast Iron 330-450 HB	30.48-106.68	45.72-106.68	60.96-152.40	18.29-45.72	---	60.96-167.64	76.20-182.88	---	106.68-289.56	365.76-548.64	---	---
Alloy / Ductile Irons	30.48-106.68	45.72-91.44	60.96-121.92	18.29-45.72	60.96-152.40	76.20-137.16	60.96-137.16	76.20-213.36	106.68-289.56	---	---	---
Free Machining Aluminum Alloys	152.40-609.60	45.72-609.60	91.44-609.60	18.29-45.72	---	182.88-670.56	182.88-762.00	---	---	---	---	304.80-2,438.4
High-Silicon Aluminum Alloys	---	---	---	---	---	---	---	---	---	---	---	304.80-1,524.0
Copper / Zinc / Brass	60.96-213.36	45.72-213.36	60.96-274.32	---	---	91.44-274.32	121.92-304.80	---	---	---	---	304.80-1,219.2
Non-Metallics	121.92-426.72	45.72-457.20	91.44-457.20	---	---	106.68-417.60	121.92-457.20	---	---	---	---	304.80-1,566.0
High Temperature Alloys 200-260 HB	24.38-39.62	30.48-53.34	30.48-60.96	15.24-24.38	---	24.38-60.96	30.48-76.20	---	---	91.44-182.88	---	---
High Temperature Alloys 260-450 HB	15.24-30.48	24.38-45.72	30.48-53.34	15.24-24.38	---	24.38-53.34	30.48-60.96	---	---	76.20-137.16	---	---
Titanium Alloys (Ti 6Al-4V)	30.48-60.96	30.48-76.20	45.72-91.44	15.24-24.38	---	24.38-91.44	30.48-91.44	---	---	---	---	---
Hardened Materials 48-65 HRC	---	---	---	---	---	---	24.38-45.72	---	---	45.72-106.68	60.96-167.64	---

Bold print items denote the top choices for the materials listed, provided it can be machined within the SFM stated under the appropriate machining conditions. For the best performance in optimal machining conditions, select the grade that will provide you with the highest allowable SFM.



ACME THREADING

FLA

For Flo-Lock acme thread limits see pg. 108.

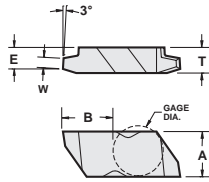

RH Shown



Description	EDP Code	TPI	W	T	E	A	B	Gage Dia.	Coating					
									C3	GP3	GP50	AC3	AC50	
FLA-3R16	553016R	16	0.52	4.95	3.78	8.74	10.23	9.53						
FLA-3L16	553016L	16	0.52	4.95	3.78	8.74	10.23	9.53						
FLA-3R14	553014R	14	0.61	4.95	3.78	8.74	10.23	9.53						
FLA-3L14	553014L	14	0.61	4.95	3.78	8.74	10.23	9.53						
FLA-3R12	553012R	12	0.72	4.95	3.78	8.74	10.23	9.53						
FLA-3L12	553012L	12	0.72	4.95	3.78	8.74	10.23	9.53						
FLA-3R10	553010R	10	0.81	4.95	3.78	8.74	10.23	9.53						
FLA-3L10	553010L	10	0.81	4.95	3.78	8.74	10.23	9.53						
FLA-3R8	553008R	8	1.04	4.95	3.78	8.74	10.23	9.53						
FLA-3L8	553008L	8	1.04	4.95	3.78	8.74	10.23	9.53						
FLA-3R6	553006R	6	1.44	4.95	3.78	8.74	10.23	9.53						
FLA-3L6	553006L	6	1.44	4.95	3.78	8.74	10.23	9.53						
FLA-3R5	553005R	5	1.75	4.95	3.78	8.74	10.23	9.53						
FLA-3L5	553005L	5	1.75	4.95	3.78	8.74	10.23	9.53						
FLA-3R4	553004R	4	2.22	4.95	3.38	8.74	10.21	9.53						
FLA-3L4	553004L	4	2.22	4.95	3.38	8.74	10.21	9.53						
FLA-4R8	554008R	8	1.04	6.48	5.13	11.51	16.08	9.53						
FLA-4L8	554008L	8	1.04	6.48	5.13	11.51	16.08	9.53						
FLA-4R6	554006R	6	1.44	6.48	5.13	11.51	16.08	9.53						
FLA-4L6	554006L	6	1.44	6.48	5.13	11.51	16.08	9.53						
FLA-4R5	554005R	5	1.75	6.48	5.13	11.51	16.08	9.53						
FLA-4L5	554005L	5	1.75	6.48	5.13	11.51	16.08	9.53						
FLA-4R4	554004R	4	2.22	6.48	5.13	11.51	16.08	9.53						
FLA-4L4	554004L	4	2.22	6.48	5.13	11.51	16.08	9.53						
FLA-6R3	556003R	3	3.01	9.73	7.19	11.51	16.02	9.53						
FLA-6L3	556003L	3	3.01	9.73	7.19	11.51	16.02	9.53						
FLA-6R2.5	5560025R	2.5	3.63	9.73	7.19	11.51	16.02	9.53						
FLA-6L2.5	5560025L	2.5	3.63	9.73	7.19	11.51	16.02	9.53						
FLA-6R2	556002R	2	4.58	9.73	7.19	11.51	16.02	9.53						
FLA-6L2	556002L	2	4.58	9.73	7.19	11.51	16.02	9.53						

FLO-LOCK

ACME STUB THREADING

FLAS

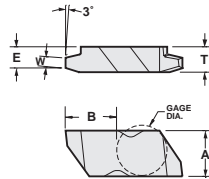

RH Shown

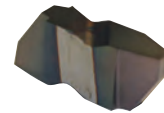

Description	EDP Code	TPI	W	T	E	A	B	Gage Dia.	Coating					
									C3	GP3	GP50	AC3	AC50	
FLAS-3R16	553216R	16	0.60	4.95	3.78	8.74	10.23	9.53						
FLAS-3L16	553216L	16	0.60	4.95	3.78	8.74	10.23	9.53						
FLAS-3R14	553214R	14	0.70	4.95	3.78	8.74	10.23	9.53						
FLAS-3L14	553214L	14	0.70	4.95	3.78	8.74	10.23	9.53						
FLAS-3R12	553212R	12	0.83	4.95	3.78	8.74	10.23	9.53						
FLAS-3L12	553212L	12	0.83	4.95	3.78	8.74	10.23	9.53						
FLAS-3R10	553210R	10	0.94	4.95	3.78	8.74	10.23	9.53						
FLAS-3L10	553210L	10	0.94	4.95	3.78	8.74	10.23	9.53						
FLAS-3R8	553208R	8	1.21	4.95	3.78	8.74	10.23	9.53						
FLAS-3L8	553208L	8	1.21	4.95	3.78	8.74	10.23	9.53						
FLAS-3R6	553206R	6	1.66	4.95	3.78	8.74	10.23	9.53						
FLAS-3L6	553206L	6	1.66	4.95	3.78	8.74	10.23	9.53						
FLAS-3R5	553205R	5	2.01	4.95	3.78	8.74	10.23	9.53						
FLAS-3L5	553205L	5	2.01	4.95	3.78	8.74	10.23	9.53						
FLAS-3R4	553204R	4	2.55	4.95	3.78	8.74	10.23	9.53						
FLAS-3L4	553204L	4	2.55	4.95	3.78	8.74	10.23	9.53						
FLAS-4R3	554203R	3	3.44	6.48	5.13	11.51	16.08	9.53						
FLAS-4L3	554203L	3	3.44	6.48	5.13	11.51	16.08	9.53						
FLAS-6R2	556202R	2	5.23	9.73	7.19	11.51	16.02	9.53						
FLAS-6L2	556202L	2	5.23	9.73	7.19	11.51	16.02	9.53						

In an effort to improve our stock standard grade offering, there are periodic changes. Please see current price list for up to date grade offering.

- High performance choice in optimal conditions.
- ▲ Recommended grade under general conditions.

Cast Iron		▲		●		
Non-Ferrous		▲		●		
Stainless/High Temp		▲		●		
Steel			▲		●	



PARTIAL TOPPING ACME THREADING

FLA-PT (with corner radii)

For Flo-Lock acme thread limits see pg. 108.

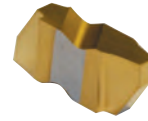
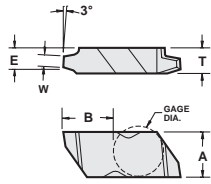

RH Shown

Description	EDP Code	TPI	W	T	E	A	B	Gage Dia.	Coating					
									C3	GP3	GP50	AC3	AC50	
FLA-3R16-PT-E	553016PTR	16	0.52	4.95	3.79	8.74	10.23	9.53						
FLA-3L16-PT-I	553016PTL	16	0.52	4.95	3.79	8.74	10.23	9.53						
FLA-3R14-PT-E	553014PTR	14	0.61	4.95	3.79	8.74	10.23	9.53						
FLA-3L14-PT-I	553014PTL	14	0.61	4.95	3.79	8.74	10.23	9.53						
FLA-3R12-PT-E	553012PTR	12	0.72	4.95	3.79	8.74	10.23	9.53						
FLA-3L12-PT-I	553012PTL	12	0.72	4.95	3.79	8.74	10.23	9.53						
FLA-3R10-PT-E	553010PTR	10	0.81	4.95	3.79	8.74	10.23	9.53						
FLA-3L10-PT-I	553010PTL	10	0.81	4.95	3.79	8.74	10.23	9.53						
FLA-3R8-PT-E	553008PTR	8	1.04	4.95	3.79	8.74	10.23	9.53						
FLA-3L8-PT-I	553008PTL	8	1.04	4.95	3.79	8.74	10.23	9.53						
FLA-3R6-PT-E	553006PTR	6	1.44	4.95	3.79	8.74	10.23	9.53						
FLA-3L6-PT-I	553006PTL	6	1.44	4.95	3.79	8.74	10.23	9.53						
FLA-3R5-PT-E	553005PTR	5	1.75	4.95	3.79	8.74	10.23	9.53						
FLA-3L5-PT-I	553005PTL	5	1.75	4.95	3.79	8.74	10.23	9.53						
FLA-3R4-PT-E	553004PTR	4	2.22	4.95	3.38	8.74	10.21	9.53						
FLA-3L4-PT-I	553004PTL	4	2.22	4.95	3.38	8.74	10.21	9.53						
FLA-4R8-PT-E	554008PTR	8	1.04	6.48	5.13	11.51	16.08	9.53						
FLA-4L8-PT-I	554008PTL	8	1.04	6.48	5.13	11.51	16.08	9.53						
FLA-4R6-PT-E	554006PTR	6	1.44	6.48	5.13	11.51	16.08	9.53						
FLA-4L6-PT-I	554006PTL	6	1.44	6.48	5.13	11.51	16.08	9.53						
FLA-4R5-PT-E	554005PTR	5	1.75	6.48	5.13	11.51	16.08	9.53						
FLA-4L5-PT-I	554005PTL	5	1.75	6.48	5.13	11.51	16.08	9.53						
FLA-4R4-PT-E	554004PTR	4	2.22	6.48	5.13	11.51	16.08	9.53						
FLA-4L4-PT-I	554004PTL	4	2.22	6.48	5.13	11.51	16.08	9.53						
FLA-6R3-PT-E	556003PTR	3	3.01	9.73	7.19	11.51	16.02	9.53						
FLA-6L3-PT-I	556003PTL	3	3.01	9.73	7.19	11.51	16.02	9.53						
FLA-6R2.5-PT-E	556025PTR	2.5	3.63	9.73	7.19	11.51	16.02	9.53						
FLA-6L2.5-PT-I	556025PTL	2.5	3.63	9.73	7.19	11.51	16.02	9.53						
FLA-6R2-PT-E	556002PTR	2	4.58	9.73	7.19	11.51	16.02	9.53						
FLA-6L2-PT-I	556002PTL	2	4.58	9.73	7.19	11.51	16.02	9.53						

FLO-LOCK

PARTIAL TOPPING ACME STUB THREADING

FLAS-PT (with corner radii)

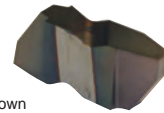
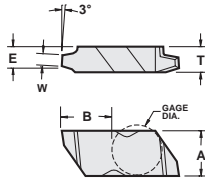

RH Shown

Description	EDP Code	TPI	W	T	E	A	B	Gage Dia.	Coating					
									C3	GP3	GP50	AC3	AC50	
FLAS-3R16-PT-E	553216PTR	16	0.60	4.95	3.79	8.74	10.23	9.53						
FLAS-3L16-PT-I	553216PTL	16	0.60	4.95	3.79	8.74	10.23	9.53						
FLAS-3R14-PT-E	553214PTR	14	0.70	4.95	3.79	8.74	10.23	9.53						
FLAS-3L14-PT-I	553214PTL	14	0.70	4.95	3.79	8.74	10.23	9.53						
FLAS-3R12-PT-E	553212PTR	12	0.83	4.95	3.79	8.74	10.23	9.53						
FLAS-3L12-PT-I	553212PTL	12	0.83	4.95	3.79	8.74	10.23	9.53						
FLAS-3R10-PT-E	553210PTR	10	0.94	4.95	3.79	8.74	10.23	9.53						
FLAS-3L10-PT-I	553210PTL	10	0.94	4.95	3.79	8.74	10.23	9.53						
FLAS-3R8-PT-E	553208PTR	8	1.21	4.95	3.79	8.74	10.23	9.53						
FLAS-3L8-PT-I	553208PTL	8	1.21	4.95	3.79	8.74	10.23	9.53						
FLAS-3R6-PT-E	553206PTR	6	1.66	4.95	3.79	8.74	10.23	9.53						
FLAS-3L6-PT-I	553206PTL	6	1.66	4.95	3.79	8.74	10.23	9.53						
FLAS-3R5-PT-E	553205PTR	5	2.01	4.95	3.79	8.74	10.23	9.53						
FLAS-3L5-PT-I	553205PTL	5	2.01	4.95	3.79	8.74	10.23	9.53						
FLAS-3R4-PT-E	553204PTR	4	2.55	4.95	3.79	8.74	10.23	9.53						
FLAS-3L4-PT-I	553204PTL	4	2.55	4.95	3.79	8.74	10.23	9.53						
FLAS-4R3-PT-E	554203PTR	3	3.44	6.48	5.13	11.51	16.08	9.53						
FLAS-4L3-PT-I	554203PTL	3	3.44	6.48	5.13	11.51	16.08	9.53						
FLAS-6R2-PT-E	556202PTR	2	5.23	9.73	7.19	11.51	16.02	9.53						
FLAS-6L2-PT-I	556202PTL	2	5.23	9.73	7.19	11.51	16.02	9.53						

In an effort to improve our stock standard grade offering, there are periodic changes. Please see current price list for up to date grade offering.

- High performance choice in optimal conditions.
- ▲ Recommended grade under general conditions.

Material	C3	GP3	GP50	AC3	AC50
Cast Iron			▲		●
Non-Ferrous		▲			●
Stainless/High Temp			▲		●
Steel				▲	●



AMERICAN STANDARD BUTTRESS 7° LEAD FLT B

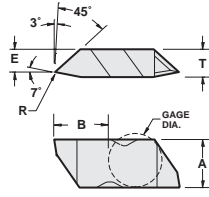

RH Shown

For ASB specifications and application see pg. 107.

Description	EDP Code	TPI	R	T	E	A	B	Gage Dia.	Coating				
									C3	GP3	GP50	AC3	AC50
FLT B-2RA	602801R	16-20	0.05/0.10	3.81	3.20	5.56	6.83	4.76	●	●	●	●	●
FLT B-2LA	602801L	16-20	0.05/0.10	3.81	3.20	5.56	6.83	4.76	●	●	●	●	●
FLT B-3RA	603801R	8-16	0.13/0.20	4.95	4.17	8.74	10.25	9.53	●	●	●	●	●
FLT B-3LA	603801L	8-16	0.13/0.20	4.95	4.17	8.74	10.25	9.53	●	●	●	●	●
FLT B-4RA	604801R	4-6	0.20/0.30	6.48	5.23	11.51	16.09	9.53	●	●	●	●	●
FLT B-4LA	604801L	4-6	0.20/0.30	6.48	5.23	11.51	16.09	9.53	●	●	●	●	●

AMERICAN STANDARD BUTTRESS 45° LEAD FLT B

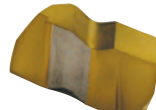
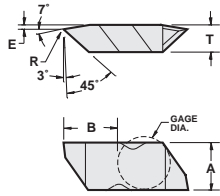

RH Shown

For ASB specifications and application see pg. 107.

Description	EDP Code	TPI	R	T	E	A	B	Gage Dia.	Coating				
									C3	GP3	GP50	AC3	AC50
FLT B-2RB	602802R	16-20	0.05/0.10	3.81	0.25	5.56	6.67	4.76	●	●	●	●	●
FLT B-2LB	602802L	16-20	0.05/0.10	3.81	0.25	5.56	6.67	4.76	●	●	●	●	●
FLT B-3RB	603802R	8-16	0.13/0.20	4.95	0.30	8.74	10.04	9.53	●	●	●	●	●
FLT B-3LB	603802L	8-16	0.13/0.20	4.95	0.30	8.74	10.04	9.53	●	●	●	●	●
FLT B-4RB	604802R	4-6	0.20/0.30	6.48	0.41	11.51	15.84	9.53	●	●	●	●	●
FLT B-4LB	604802L	4-6	0.20/0.30	6.48	0.41	11.51	15.84	9.53	●	●	●	●	●

API BUTTRESS THREADING FLDC

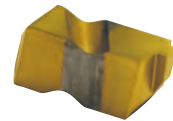
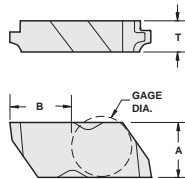

RH EXT Shown

Description	EDP Code	TPI	TPF	T	A	B	Gage Dia.	Coating				
								C3	GP3	GP50	AC3	AC50
FLDC-3-5B75E	553616E	5	3/4	6.35	8.74	10.23	9.53	●	●	●	●	●
FLDC-3-5B75I	553616I	5	3/4	6.35	8.74	10.23	9.53	●	●	●	●	●
FLDC-3-5B1E	553617E	5	1	6.35	8.74	10.23	9.53	●	●	●	●	●
FLDC-3-5B1I	553617I	5	1	6.35	8.74	10.23	9.53	●	●	●	●	●
FLDC-4-5B75E	554616E	5	3/4	6.48	11.51	16.05	9.53	●	●	●	●	●
FLDC-4-5B75I	554616I	5	3/4	6.48	11.51	16.05	9.53	●	●	●	●	●
FLDC-4-5B1E	554617E	5	1	6.48	11.51	16.05	9.53	●	●	●	●	●
FLDC-4-5B1I	554617I	5	1	6.48	11.51	16.05	9.53	●	●	●	●	●

API THREADING NON TOPPING FLD

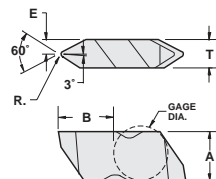

RH Shown

Description	EDP Code	TPI	R	E	T	A	B	Gage Dia.	Coating				
									C3	GP3	GP50	AC3	AC50
FLD-3038R	553438R	4	0.84/0.97	2.08	4.95	8.74	10.14	9.53	●	●	●	●	●
FLD-3038L	553438L	4	0.84/0.97	2.08	4.95	8.74	10.14	9.53	●	●	●	●	●
FLD-3040R	553440R	5	0.38/0.51	2.08	4.95	8.74	10.14	9.53	●	●	●	●	●
FLD-3040L	553440L	5	0.38/0.51	2.08	4.95	8.74	10.14	9.53	●	●	●	●	●
FLD-4038R	554438R	4	0.84/0.97	3.25	6.48	11.51	15.98	9.53	●	●	●	●	●
FLD-4038L	554438L	4	0.84/0.97	3.25	6.48	11.51	15.98	9.53	●	●	●	●	●
FLD-4040R	554440R	5	0.38/0.51	3.25	6.48	11.51	15.98	9.53	●	●	●	●	●
FLD-4040L	554440L	5	0.38/0.51	3.25	6.48	11.51	15.98	9.53	●	●	●	●	●
FLD-4050R	554450R	4	0.51/0.64	3.25	6.48	11.51	15.98	9.53	●	●	●	●	●
FLD-4050L	554450L	4	0.51/0.64	3.25	6.48	11.51	15.98	9.53	●	●	●	●	●

In an effort to improve our stock standard grade offering, there are periodic changes. Please see current price list for up to date grade offering.

- High performance choice in optimal conditions.
- ▲ Recommended grade under general conditions.

Material	▲	●
Cast Iron	▲	●
Non-Ferrous	▲	●
Stainless/High Temp	▲	●
Steel	▲	●



FLO-LOCK

API ROTARY SHOULDER CONNECTION THREADING FLDC

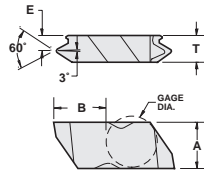

RH EXT Shown

Description	EDP Code	TPI	TPF	E	T	A	B	Gage Dia.	Conn. No. or Size	Coating				
										GP3	GP50	AC22	AC3	AC50
FLDC-3-530E	553613E	5	3	3.73	6.35	8.74	10.23	9.53	3-1/2 FH, 2-3/8-4-1/2 Reg.	●	●			
FLDC-3-530I	553613I	5	3	3.73	6.35	8.74	10.23	9.53	3-1/2 FH, 2-3/8-4-1/2 Reg.	●	●			
FLDC-4-425E	554609E	4	2	4.65	7.92	11.51	16.05	9.53	5-1/2 FH, 6-5/8 FH & Reg.	●	●	●	●	
FLDC-4-425I	554609I	4	2	4.65	7.92	11.51	16.05	9.53	5-1/2 FH, 6-5/8 FH & Reg.	●	●	●	●	
FLDC-4-428E	554610E	4	2	4.65	7.92	11.51	16.05	9.53	NC23-NC50, 2-3/8-5-1/2IF	●	●	●		●
FLDC-4-428I	554610I	4	2	4.65	7.92	11.51	16.05	9.53	NC23-NC50, 2-3/8-5-1/2IF	●	●	●		●
FLDC-4-435E	554611E	4	3	4.65	7.92	11.51	16.05	9.53	5-1/2, 7-5/8, 8-5/8 Reg.	●	●			
FLDC-4-435I	554611I	4	3	4.65	7.92	11.51	16.05	9.53	5-1/2, 7-5/8, 8-5/8 Reg.	●	●			
FLDC-4-438E	554612E	4	3	4.65	7.92	11.51	16.05	9.53	NC56 - NC71	●	●			
FLDC-4-438I	554612I	4	3	4.65	7.92	11.51	16.05	9.53	NC56 - NC71	●	●			

API ROUND THREADING FLDC

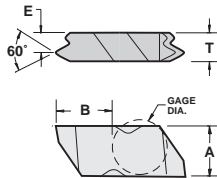

RH Shown

Description	EDP Code	TPI	TPF	E	T	A	B	Gage Dia.	Coating					
									C3	GP3	GP50	AC3	AC50	
FLDC-3-8RDR75	553632R	8	3/4	3.18	4.95	8.74	10.19	9.53			●	●	●	●
FLDC-3-8RDL75	553632L	8	3/4	3.18	4.95	8.74	10.19	9.53			●	●	●	●
FLDC-3-10RDR75	553634R	10	3/4	3.18	4.95	8.74	10.19	9.53			●	●	●	●
FLDC-3-10RDL75	553634L	10	3/4	3.18	4.95	8.74	10.19	9.53			●	●	●	●

FLDC with chipbreaker

Exclusive patented design!

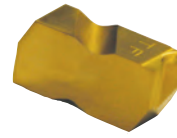
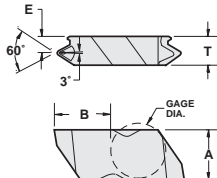

RH Shown

Description	EDP Code	TPI	TPF	E	T	A	B	Gage Dia.	Coating					
									C3	GP3	GP50	AC3	AC50	
FLDC-3-8RDR75-CB	553632PR	8	3/4	3.18	4.95	8.74	10.19	9.53			●	●	●	●
FLDC-3-8RDL75-CB	553632PL	8	3/4	3.18	4.95	8.74	10.19	9.53			●	●	●	●

FLDC Multi-tooth

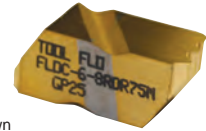
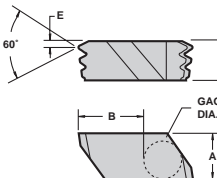

RH Shown

Description	EDP Code	TPI	TPF	E	T	A	B	Gage Dia.	Coating					
									C3	GP3	GP50	AC3	AC50	
FLDC-6-8RDR75M	5566323R	8	3/4	1.78	9.73	11.51	16.15	9.53			●	●	●	●
FLDC-6-10RDR75M	556634R	10	3/4	3.40	9.73	11.51	16.15	9.53			●	●	●	●

NPT THREADING FLDC

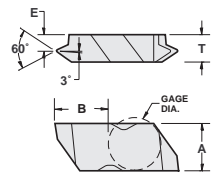

RH Shown

Description	EDP Code	TPI	TPF	E	T	A	B	Gage Dia.	Coating					
									C3	GP3	GP50	AC3	AC50	
FLDC-38VR-75	553608R	8	3/4	2.54	4.95	8.74	10.16	9.53			●	●	●	●
FLDC-38VL-75	553608L	8	3/4	2.54	4.95	8.74	10.16	9.53			●	●	●	●
FLDC-3115VR-75	553611R	11.5	3/4	3.66	4.95	8.74	10.16	9.53			●	●	●	●
FLDC-3115VL-75	553611L	11.5	3/4	3.66	4.95	8.74	10.16	9.53			●	●	●	●
FLDC-314VR-75	553614R	14	3/4	3.76	4.95	8.74	10.22	9.53			●	●	●	●
FLDC-314VL-75	553614L	14	3/4	3.76	4.95	8.74	10.22	9.53			●	●	●	●
FLDC-318VR-75	553618R	18	3/4	3.91	4.95	8.74	10.22	9.53			●	●	●	●
FLDC-318VL-75	553618L	18	3/4	3.91	4.95	8.74	10.22	9.53			●	●	●	●
FLDC-327VR-75	553627R	27	3/4	4.11	4.95	8.74	10.22	9.53			●	●	●	●
FLDC-327VL-75	553627L	27	3/4	4.11	4.95	8.74	10.22	9.53			●	●	●	●

In an effort to improve our stock standard grade offering, there are periodic changes. Please see current price list for up to date grade offering.

- High performance choice in optimal conditions.
- ▲ Recommended grade under general conditions.

Material	GP3	GP50	AC3	AC50
Cast Iron				●
Non-Ferrous				●
Stainless/High Temp			▲	●
Steel				●



NPT THREADING

FLDC

Multi-tooth

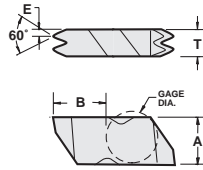

RH Shown



Description	EDP Code	TPI	TPF	E	T	A	B	Gage Dia.					
									C3	GP3	GP50	AC3	AC50
FLDC-3-8 NPT-2E	553708E	8	3/4	1.47	6.35	8.74	10.29	9.53					
FLDC -3-8 NPT-2I	553708I	8	3/4	1.47	6.35	8.74	10.29	9.53					
FLDC-3-11.5 NPT-2E	553711E	11.5	3/4	1.22	6.35	8.74	10.29	9.53					
FLDC-3-11.5 NPT-2I	553711I	11.5	3/4	1.22	6.35	8.74	10.29	9.53					

Uncoated		TIN Coated		AITIN Coated	
C3	GP3	GP50	AC3	AC50	

UNJ THREADING

FLJ

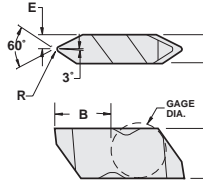

RH Shown

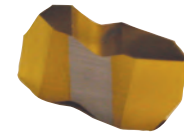

Description	EDP Code	TPI	R	E	T	A	B	Gage Dia.					
									C3	GP3	GP50	AC3	AC50
FLJ-3010R16	583216R	16	0.24/0.26	2.49	4.95	8.74	10.16	9.53					
FLJ-3010L16	583216L	16	0.24/0.26	2.49	4.95	8.74	10.16	9.53					
FLJ-3014R12	583212R	12	0.32/0.34	2.49	4.95	8.74	10.16	9.53					
FLJ-3014L12	583212L	12	0.32/0.34	2.49	4.95	8.74	10.16	9.53					
FLJ-3020R8	583208R	8	0.48/0.50	2.49	4.95	8.74	10.16	9.53					
FLJ-3020L8	583208L	8	0.48/0.50	2.49	4.95	8.74	10.16	9.53					

Uncoated		TIN Coated		AITIN Coated	
C3	GP3	GP50	AC3	AC50	

UNJ THREADING

FLJP

Positive rake

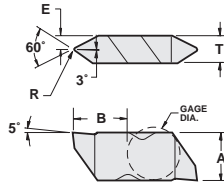

RH Shown

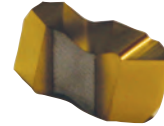

Description	EDP Code	TPI	R	E	T	A	B	Gage Dia.					
									C3	GP3	GP50	AC3	AC50
FLJP-3010R16	583816R	16	0.24/0.26	2.49	4.95	8.74	10.16	9.53					
FLJP-3010L16	583816L	16	0.24/0.26	2.49	4.95	8.74	10.16	9.53					
FLJP-3014R12	583812R	12	0.32/0.34	2.49	4.95	8.74	10.16	9.53					
FLJP-3014L12	583812L	12	0.32/0.34	2.49	4.95	8.74	10.16	9.53					
FLJP-3020R8	583808R	8	0.48/0.50	2.49	4.95	8.74	10.16	9.53					
FLJP-3020L8	583808L	8	0.48/0.50	2.49	4.95	8.74	10.16	9.53					

Uncoated		TIN Coated		AITIN Coated	
C3	GP3	GP50	AC3	AC50	

UNJ FINE PITCH THREADING

FLJF

For cutting close to shoulder

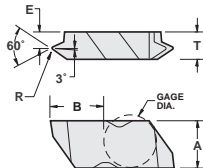

RH Shown



Description	EDP Code	TPI	R	E	T	A	B	Gage Dia.					
									C3	GP3	GP50	AC3	AC50
FLJF-3005R32	583432R	32	0.12/0.15	3.58	4.95	8.74	10.22	9.53					
FLJF-3005L32	583432L	32	0.12/0.15	3.58	4.95	8.74	10.22	9.53					
FLJF-3006R28	583428R	28	0.14/0.16	3.58	4.95	8.74	10.22	9.53					
FLJF-3006L28	583428L	28	0.14/0.16	3.58	4.95	8.74	10.22	9.53					
FLJF-3007R24	583424R	24	0.16/0.19	3.58	4.95	8.74	10.22	9.53					
FLJF-3007L24	583424L	24	0.16/0.19	3.58	4.95	8.74	10.22	9.53					
FLJF-3008R20	583420R	20	0.19/0.22	3.58	4.95	8.74	10.22	9.53					
FLJF-3008L20	583420L	20	0.19/0.22	3.58	4.95	8.74	10.22	9.53					
FLJF-3009R18	583418R	18	0.21/0.24	3.58	4.95	8.74	10.22	9.53					
FLJF-3009L18	583418L	18	0.21/0.24	3.58	4.95	8.74	10.22	9.53					
FLJF-3010R16	583416R	16	0.24/0.26	3.58	4.95	8.74	10.22	9.53					
FLJF-3010L16	583416L	16	0.24/0.26	3.58	4.95	8.74	10.22	9.53					
FLJF-3012R14	583414R	14	0.27/0.30	3.58	4.95	8.74	10.22	9.53					
FLJF-3012L14	583414L	14	0.27/0.30	3.58	4.95	8.74	10.22	9.53					

Uncoated		TIN Coated		AITIN Coated	
C3	GP3	GP50	AC3	AC50	

In an effort to improve our stock standard grade offering, there are periodic changes. Please see current price list for up to date grade offering.

- High performance choice in optimal conditions.
- ▲ Recommended grade under general conditions.

Cast Iron		▲		●
Non-Ferrous		▲		●
Stainless/High Temp		▲		●
Steel			▲	



UNJ FINE PITCH THREADING

FLJK - Positive rake

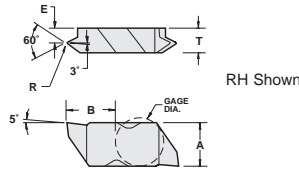

Description	EDP Code	TPI	R	E	T	A	B	Gage Dia.	Coating				
									C3	GP3	GP50	AC3	AC50
FLJK-3005R32	583632R	32	0.12/0.15	3.58	4.95	8.74	10.22	9.53					
FLJK-3005L32	583632L	32	0.12/0.15	3.58	4.95	8.74	10.22	9.53					
FLJK-3006R28	583628R	28	0.14/0.16	3.58	4.95	8.74	10.22	9.53					
FLJK-3006L28	583628L	28	0.14/0.16	3.58	4.95	8.74	10.22	9.53					
FLJK-3007R24	583624R	24	0.16/0.19	3.58	4.95	8.74	10.22	9.53					
FLJK-3007L24	583624L	24	0.16/0.19	3.58	4.95	8.74	10.22	9.53					
FLJK-3008R20	583620R	20	0.19/0.22	3.58	4.95	8.74	10.22	9.53					
FLJK-3008L20	583620L	20	0.19/0.22	3.58	4.95	8.74	10.22	9.53					
FLJK-3009R18	583618R	18	0.21/0.24	3.58	4.95	8.74	10.22	9.53					
FLJK-3009L18	583618L	18	0.21/0.24	3.58	4.95	8.74	10.22	9.53					
FLJK-3010R16	583616R	16	0.24/0.26	3.58	4.95	8.74	10.22	9.53					
FLJK-3010L16	583616L	16	0.24/0.26	3.58	4.95	8.74	10.22	9.53					
FLJK-3012R14	583614R	14	0.27/0.30	3.58	4.95	8.74	10.22	9.53					
FLJK-3012L14	583614L	14	0.27/0.30	3.58	4.95	8.74	10.22	9.53					

UN THREADING

FLTC

Crest topping

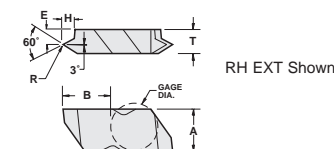

Description	EDP Code	TPI	R	E	H	T	A	B	Gage Dia.	Coating				
										C3	GP3	GP50	AC3	AC50
FLTC-3R7E	613007R	7	0.43	2.72	2.74	4.95	8.74	10.17	9.53					
FLTC-3L7E	613007L	7	0.43	2.72	2.74	4.95	8.74	10.17	9.53					
FLTC-3R7I	613207R	7	0.23	2.72	2.34	4.95	8.74	10.17	9.53					
FLTC-3L7I	613207L	7	0.23	2.72	2.34	4.95	8.74	10.17	9.53					
FLTC-3R8E	613008R	8	0.38	2.72	2.39	4.95	8.74	10.17	9.53					
FLTC-3L8E	613008L	8	0.38	2.72	2.39	4.95	8.74	10.17	9.53					
FLTC-3R8I	613208R	8	0.18	2.72	2.06	4.95	8.74	10.17	9.53					
FLTC-3L8I	613208L	8	0.18	2.72	2.06	4.95	8.74	10.17	9.53					
FLTC-3R9E	613009R	9	0.33	2.72	2.13	4.95	8.74	10.17	9.53					
FLTC-3L9E	613009L	9	0.33	2.72	2.13	4.95	8.74	10.17	9.53					
FLTC-3R9I	613209R	9	0.15	2.72	1.83	4.95	8.74	10.17	9.53					
FLTC-3L9I	613209L	9	0.15	2.72	1.83	4.95	8.74	10.17	9.53					
FLTC-3R10E	613010R	10	0.30	2.72	1.93	4.95	8.74	10.17	9.53					
FLTC-3L10E	613010L	10	0.30	2.72	1.93	4.95	8.74	10.17	9.53					
FLTC-3R10I	613210R	10	0.13	2.72	1.65	4.95	8.74	10.17	9.53					
FLTC-3L10I	613210L	10	0.13	2.72	1.65	4.95	8.74	10.17	9.53					
FLTC-3R11E	613011R	11	0.28	2.72	1.75	4.95	8.74	10.17	9.53					
FLTC-3L11E	613011L	11	0.28	2.72	1.75	4.95	8.74	10.17	9.53					
FLTC-3R11I	613211R	11	0.13	2.72	1.50	4.95	8.74	10.17	9.53					
FLTC-3L11I	613211L	11	0.13	2.72	1.50	4.95	8.74	10.17	9.53					
FLTC-3R12E	613012R	12	0.25	3.76	1.30	4.95	8.74	10.22	9.53					
FLTC-3L12E	613012L	12	0.25	3.76	1.30	4.95	8.74	10.22	9.53					
FLTC-3R12I	613212R	12	0.10	3.76	1.22	4.95	8.74	10.22	9.53					
FLTC-3L12I	613212L	12	0.10	3.76	1.22	4.95	8.74	10.22	9.53					
FLTC-3R14E	613014R	14	0.23	3.76	1.37	4.95	8.74	10.22	9.53					
FLTC-3L14E	613014L	14	0.23	3.76	1.37	4.95	8.74	10.22	9.53					
FLTC-3R14I	613214R	14	0.08	3.76	1.12	4.95	8.74	10.22	9.53					
FLTC-3L14I	613214L	14	0.08	3.76	1.12	4.95	8.74	10.22	9.53					
FLTC-3R16E	613016R	16	0.20	3.76	1.17	4.95	8.74	10.22	9.53					
FLTC-3L16E	613016L	16	0.20	3.76	1.17	4.95	8.74	10.22	9.53					
FLTC-3R16I	613216R	16	0.08	3.76	1.02	4.95	8.74	10.22	9.53					
FLTC-3L16I	613216L	16	0.08	3.76	1.02	4.95	8.74	10.22	9.53					
FLTC-3R18E	613018R	18	0.18	3.76	1.04	4.95	8.74	10.22	9.53					
FLTC-3L18E	613018L	18	0.18	3.76	1.04	4.95	8.74	10.22	9.53					
FLTC-3R18I	613218R	18	0.08	3.76	0.91	4.95	8.74	10.22	9.53					
FLTC-3L18I	613218L	18	0.08	3.76	0.91	4.95	8.74	10.22	9.53					
FLTC-3R20E	613020R	20	0.15	3.76	0.94	4.95	8.74	10.22	9.53					
FLTC-3L20E	613020L	20	0.15	3.76	0.94	4.95	8.74	10.22	9.53					
FLTC-3R20I	613220R	20	0.08	3.76	0.79	4.95	8.74	10.22	9.53					
FLTC-3L20I	613220L	20	0.08	3.76	0.79	4.95	8.74	10.22	9.53					
FLTC-3R24E	613024R	24	0.13	3.76	0.79	4.95	8.74	10.22	9.53					
FLTC-3L24E	613024L	24	0.13	3.76	0.79	4.95	8.74	10.22	9.53					
FLTC-3R24I	613224R	24	0.08	3.76	0.66	4.95	8.74	10.22	9.53					
FLTC-3L24I	613224L	24	0.08	3.76	0.66	4.95	8.74	10.22	9.53					
FLTC-3R28*	613028R	28	0.08	3.76	0.58	4.95	8.74	10.22	9.53					
FLTC-3L28*	613028L	28	0.08	3.76	0.58	4.95	8.74	10.22	9.53					
FLTC-3R32*	613028R	32	0.08	3.76	0.53	4.95	8.74	10.22	9.53					
FLTC-3L32*	613028L	32	0.08	3.76	0.53	4.95	8.74	10.22	9.53					

*Will work for either internal or external.

In an effort to improve our stock standard grade offering, there are periodic changes. Please see current price list for up to date grade offering.

- High performance choice in optimal conditions.
- ▲ Recommended grade under general conditions.

Material	C3	GP3	GP50	AC3	AC50
Cast Iron					
Non-Ferrous					
Stainless/High Temp					
Steel					



60° V-THREADING

FLTF

Fine pitch

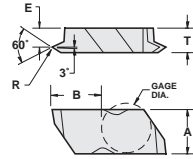

RH Shown

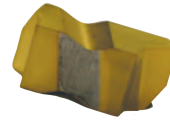

Uncoated	C25	GP3	GP4	GP50	GP520	AC3	AC50	TIN Coated	AITIN Coated

For 60°V-thread limits see pg. 107.

Description	EDP Code	TPI		R	E	T	A	B	Gage Dia.	Coatings										
		Int	Ext							C25	GP3	GP4	GP50	GP520	AC3	AC50	TIN Coated	AITIN Coated		
FLTF-2R	612400R	12-24	14-44	0.05/0.10	2.79	3.81	5.56	6.80	4.76	●	●	●	●	●	●	●	●	●	●	●
FLTF-2L	612400L	12-24	14-44	0.05/0.10	2.79	3.81	5.56	6.80	4.76	●	●	●	●	●	●	●	●	●	●	●
FLTF-3R	613400R	9-24	10-44	0.05/0.10	3.58	4.95	8.74	10.22	9.53	●	●	●	●	●	●	●	●	●	●	●
FLTF-3L	613400L	9-24	10-44	0.05/0.10	3.58	4.95	8.74	10.22	9.53	●	●	●	●	●	●	●	●	●	●	●
FLTF-4R	614400R	9-24	10-44	0.05/0.10	5.11	6.48	11.51	16.06	9.53	●	●	●	●	●	●	●	●	●	●	●
FLTF-4L	614400L	9-24	10-44	0.05/0.10	5.11	6.48	11.51	16.06	9.53	●	●	●	●	●	●	●	●	●	●	●

60° V-THREADING

FLTK

Positive rake

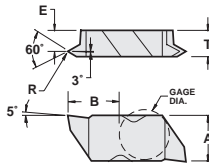

RH Shown

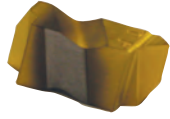

Uncoated	C25	GP3	GP4	GP50	GP520	AC3	AC50	TIN Coated	AITIN Coated

Description	EDP Code	TPI		R	E	T	A	B	Gage Dia.	Coatings										
		Int	Ext							C25	GP3	GP4	GP50	GP520	AC3	AC50	TIN Coated	AITIN Coated		
FLTK-2R	612600R	12-24	14-44	0.05/0.10	2.79	3.81	5.56	6.80	4.76	●	●	●	●	●	●	●	●	●	●	●
FLTK-2L	612600L	12-24	14-44	0.05/0.10	2.79	3.81	5.56	6.80	4.76	●	●	●	●	●	●	●	●	●	●	●
FLTK-3R	613600R	9-24	10-44	0.05/0.10	3.58	4.95	8.74	10.22	9.53	●	●	●	●	●	●	●	●	●	●	●
FLTK-3L	613600L	9-24	10-44	0.05/0.10	3.58	4.95	8.74	10.22	9.53	●	●	●	●	●	●	●	●	●	●	●
FLTK-4R	614600R	9-24	10-44	0.05/0.10	5.11	6.48	11.51	16.06	9.53	●	●	●	●	●	●	●	●	●	●	●
FLTK-4L	614600L	9-24	10-44	0.05/0.10	5.11	6.48	11.51	16.06	9.53	●	●	●	●	●	●	●	●	●	●	●

60° V-THREADING - CHIP-FLO

FLT-CB

Features:

Exclusive patented design!

- Patented chipbreaker - Patent No. 6,146,064
- Maximum chip control
- Fewer scarred threads
- For coarse and fine pitches

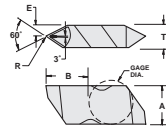

RH Shown

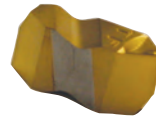

Uncoated	C25	C3	GP22	GP4	GP50	GP520	AC22	AC3	AC50	TIN Coated	AITIN Coated

Description	EDP Code	TPI		R	E	T	A	B	Gage Dia.	Coatings												
		Int	Ext							C25	C3	GP22	GP4	GP50	GP520	AC22	AC3	AC50	TIN Coated	AITIN Coated		
FLT-3R-HCB	603600HCR	5-12	6-20	0.13/0.20	2.49	4.95	8.74	10.16	9.53	●	●	●	●	●	●	●	●	●	●	●	●	●
FLT-3L-HCB	603600HCL	5-12	6-20	0.13/0.20	2.49	4.95	8.74	10.16	9.53	●	●	●	●	●	●	●	●	●	●	●	●	●
FLT-3RC-HCB	603612HCR	5-6	6-11	0.30/0.38	2.49	4.95	8.74	10.16	9.53	●	●	●	●	●	●	●	●	●	●	●	●	●
FLT-3LC-HCB	603612HCL	5-6	6-11	0.30/0.38	2.49	4.95	8.74	10.16	9.53	●	●	●	●	●	●	●	●	●	●	●	●	●
FLT-3R-CB	603600CR	8-12	8-20	0.13/0.20	2.49	4.95	8.74	10.16	9.53	●	●	●	●	●	●	●	●	●	●	●	●	●
FLT-3L-CB	603600CL	8-12	8-20	0.13/0.20	2.49	4.95	8.74	10.16	9.53	●	●	●	●	●	●	●	●	●	●	●	●	●
FLT-3R-FCB	603600FCR	7-20	8-36	0.08/0.13	2.49	4.95	8.74	10.16	9.53	●	●	●	●	●	●	●	●	●	●	●	●	●
FLT-3L-FCB	603600FCL	7-20	8-36	0.08/0.13	2.49	4.95	8.74	10.16	9.53	●	●	●	●	●	●	●	●	●	●	●	●	●
FLT-4R-HCB	604600HCR	4-12	4-20	0.13/0.20	3.25	6.48	11.51	16.00	9.53	●	●	●	●	●	●	●	●	●	●	●	●	●
FLT-4L-HCB	604600HCL	4-12	4-20	0.13/0.20	3.25	6.48	11.51	16.00	9.53	●	●	●	●	●	●	●	●	●	●	●	●	●

60° V-THREADING

FLT

For 60°V-thread limits see pg. 108.

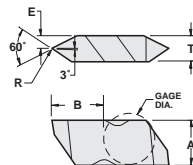

RH Shown



Uncoated	C25	GP3	GP4	GP50	GP520	AC22	AC3	AC50	TIN Coated	AITIN Coated

Description	EDP Code	TPI		R	E	T	A	B	Gage Dia.	Coatings												
		Int	Ext							C25	GP3	GP4	GP50	GP520	AC22	AC3	AC50	TIN Coated	AITIN Coated			
FLT-2R	602600R	7-20	8-36	0.08/0.13	1.91	3.81	5.56	6.76	4.76	●	●	●	●	●	●	●	●	●	●	●	●	●
FLT-2L	602600L	7-20	8-36	0.08/0.13	1.91	3.81	5.56	6.76	4.76	●	●	●	●	●	●	●	●	●	●	●	●	●
FLT-3R	603600R	5-12	6-20	0.13/0.20	2.49	4.95	8.74	10.16	9.53	●	●	●	●	●	●	●	●	●	●	●	●	●
FLT-3L	603600L	5-12	6-20	0.13/0.20	2.49	4.95	8.74	10.16	9.53	●	●	●	●	●	●	●	●	●	●	●	●	●
FLT-3010R	603610R	5-12	6-18	0.23/0.28	2.49	4.95	8.74	10.16	9.53	●	●	●	●	●	●	●	●	●	●	●	●	●
FLT-3010L	603610L	5-12	6-18	0.23/0.28	2.49	4.95	8.74	10.16	9.53	●	●	●	●	●	●	●	●	●	●	●	●	●
FLT-4R	604600R	4-12	4-20	0.13/0.20	3.25	6.48	11.51	16.00	9.53	●	●	●	●	●	●	●	●	●	●	●	●	●
FLT-4L	604600L	4-12	4-20	0.13/0.20	3.25	6.48	11.51	16.00	9.53	●	●	●	●	●	●	●	●	●	●	●	●	●

In an effort to improve our stock standard grade offering, there are periodic changes. Please see current price list for up to date grade offering.

- High performance choice in optimal conditions.
- ▲ Recommended grade under general conditions.

Cast Iron	▲																					
Non-Ferrous																						
Stainless/High Temp																						
Steel																						



60° V-THREADING

FLTP - Positive rake

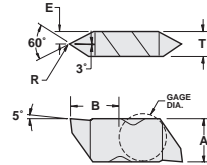

RH Shown

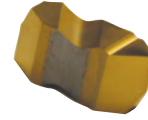

For 60° V-thread limits see pg. 108.

Description	EDP Code	TPI		R	E	T	A	B	Gage Dia.	Coatings				
		Int	Ext							C25	GP3	GP50	AC3	AC50
FLTP-2R	612800R	7-20	8-36	0.08/0.13	1.91	3.81	5.56	6.76	4.76	●	●	●	●	●
FLTP-2L	612800L	7-20	8-36	0.08/0.13	1.91	3.81	5.56	6.76	4.76	●	●	●	●	●
FLTP-3R	613800R	5-12	6-20	0.13/0.20	2.49	4.95	8.74	10.16	9.53	●	●	●	●	●
FLTP-3L	613800L	5-12	6-20	0.13/0.20	2.49	4.95	8.74	10.16	9.53	●	●	●	●	●
FLTP-4R	614800R	4-12	4-20	0.13/0.20	3.25	6.48	11.51	15.98	9.53	●	●	●	●	●
FLTP-4L	614800L	4-12	4-20	0.13/0.20	3.25	6.48	11.51	15.98	9.53	●	●	●	●	●

UNDERCUTTING

FLU

For use in FLRR/L holders

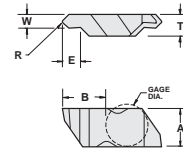

RH Shown

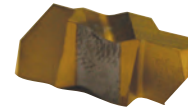

Description	EDP Code	W	R	E	T	A	B	Gage Dia.	Coatings				
									C3	GP3	GP50	AC3	AC50
FLU-3094R	623094R	2.39	0.51	3.18	4.95	8.74	10.29	9.53	●	●	●	●	●
FLU-3094L	623094L	2.39	0.51	3.18	4.95	8.74	10.29	9.53	●	●	●	●	●
FLU-3125R	623125R	3.18	1.19	4.78	4.95	8.74	10.29	9.53	●	●	●	●	●
FLU-3125L	623125L	3.18	1.19	4.78	4.95	8.74	10.29	9.53	●	●	●	●	●
FLU-3156R	623156R	3.96	1.19	4.78	4.95	8.74	10.29	9.53	●	●	●	●	●
FLU-3156L	623156L	3.96	1.19	4.78	4.95	8.74	10.29	9.53	●	●	●	●	●

POLY-V

FLV

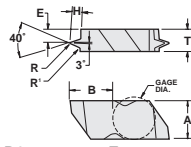

RH Shown

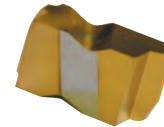

Description	EDP Code	R	R1	E	T	H	A	B	Gage Dia.	Coatings				
										C25	GP3	GP50	AC3	AC50
FLV-3RJ	623800R	0.30	0.20	3.18	4.95	2.21	8.74	10.19	9.53	●	●	●	●	●
FLV-3LJ	623800L	0.30	0.20	3.18	4.95	2.21	8.74	10.19	9.53	●	●	●	●	●
FLV-4RL	624800R	0.30	0.38	3.00	6.48	5.11	11.51	15.97	9.53	●	●	●	●	●
FLV-4LL	624800L	0.30	0.38	3.00	6.48	5.11	11.51	15.97	9.53	●	●	●	●	●

In an effort to improve our stock standard grade offering, there are periodic changes. Please see current price list for up to date grade offering.

- High performance choice in optimal conditions.
- ▲ Recommended grade under general conditions.

Material	C25	GP3	GP50	AC3	AC50
Cast Iron			▲		●
Non-Ferrous		▲			●
Stainless/High Temp		▲			●
Steel				▲	●

EXTERNAL HOLDER

FLSR/L

Threading and Grooving

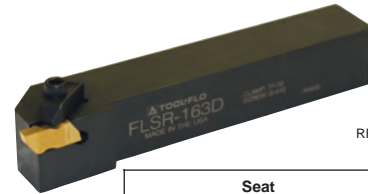
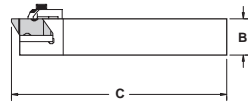
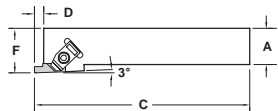

RH SHOWN

Coolant fed clamps available (See TF-CP clamps on page 105,106)

Description	EDP Code	Insert	A	B	C	D	F*	Seat	Seat Screw	Clamp	Clamp Screw
FLSR-1010M2	93411008	FL_-2R	10	10	70	3.56	14.27	-	-	TF-74	SM-310
FLSL-1010M2	93311008	FL_-2L	10	10	70	3.56	14.27	-	-	TF-75	SM-310
FLSR-1212M2	93411208	FL_-2R	12	12	80	3.56	19.05	-	-	TF-74	SM-310
FLSL-1212M2	93311208	FL_-2L	12	12	80	3.56	19.05	-	-	TF-75	SM-310
FLSR-1616M2	93411608	FL_-2R	16	16	100	3.56	25.40	-	-	TF-74	SM-310
FLSR-2020M2	93412008	FL_-2R	20	20	125	3.56	25.40	-	-	TF-74	SM-310
FLSL-2020M2	93312008	FL_-2L	20	20	125	3.56	25.40	-	-	TF-75	SM-310
FLSR-2525M2	93412508	FL_-2R	25	25	150	3.56	31.75	-	-	TF-74	SM-310
FLSL-2525M2	93312508	FL_-2L	25	25	150	3.56	31.75	-	-	TF-75	SM-310
FLSR-2020M3	93412016	FL_-3R	20	20	125	5.33	25.40	-	-	TF-72	SSM-51
FLSL-2020M3	93312016	FL_-3L	20	20	125	5.33	25.40	-	-	TF-73	SSM-51
FLSR-2525M3C	93412516C	FL_-3R	25	25	150	5.33	31.75	-	-	TF-72	SSM-51
FLSL-2525M3C	93312516C	FL_-3L	25	25	150	5.33	31.75	-	-	TF-73	SSM-51
FLSR-2525M3D	93412516D	FL_-3R	25	25	150	5.33	31.75	-	-	TF-72	SSM-51
FLSL-2525M3D	93312516D	FL_-3L	25	25	150	5.33	31.75	-	-	TF-73	SSM-51
FLSR-3232M3D	93413216D	FL_-3R	32	32	170	5.33	38.10	-	-	TF-72	SSM-51
FLSL-3232M3D	93313216D	FL_-3L	32	32	170	5.33	38.10	-	-	TF-73	SSM-51
FLSR-2525M4D	93412520D	FL_-4R	25	25	150	7.37	31.75	SM-420	SL-344	TF-72	SSM-51
FLSL-2525M4D	93312520D	FL_-4L	25	25	150	7.37	31.75	SM-420	SL-344	TF-73	SSM-51
FLSR-3232M4D	93413220D	FL_-4R	32	32	170	7.37	38.10	SM-420	SL-344	TF-72	SSM-51
FLSL-3232M4D	93313220D	FL_-4L	32	32	170	7.37	38.10	SM-420	SL-344	TF-73	SSM-51
FLSR-3232M5D	93413224D	FL_-5R	32	32	170	10.16	38.10	-	-	TF-80	SM-352
FLSL-3232M5D	93313224D	FL_-5L	32	32	170	10.16	38.10	-	-	TF-81	SM-352
FLSR-3232M6D	93413228D	FL_-6R	32	32	170	7.37	38.10	SM-416	S-111	TF-120	SM-412
FLSL-3232M6D	93313228D	FL_-6L	32	32	170	7.37	38.10	SM-416	S-111	TF-121	SM-412

* *F* Dim. over sharp point of grooving insert.



EXTERNAL HOLDER

FLER/L

Threading and Grooving

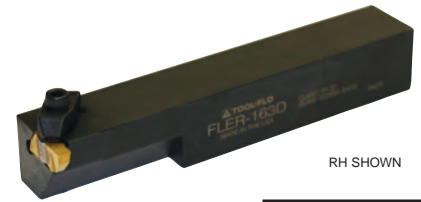
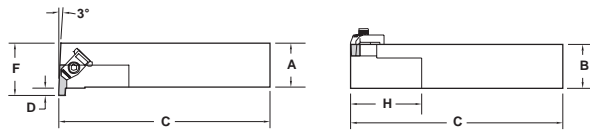

Coolant fed clamps available (See TF-CP clamps on page 106)

Description	EDP Code	Insert	A	B	C	D	F*	H	Clamp	Clamp Screw
FLER-1212M2V	931012M08V	FL_-2L	12	12	80	3.56	19.05	25.00	TF-75	SM-310
FLER-2020M2B	931012M08B	FL_-2L	20	20	125	3.56	25.40	25.00	TF-75	SM-310
FLEL-2020M2B	930020M08B	FL_-2R	20	20	125	3.56	25.40	25.00	TF-74	SM-310
FLER-2525M2C	931025M08C	FL_-2L	25	25	150	3.56	31.75	25.00	TF-75	SM-310
FLEL-2525M2C	930025M08C	FL_-2R	25	25	150	3.56	31.75	25.00	TF-74	SM-310
FLER-2020M3B	931020M16B	FL_-3L	20	20	125	5.33	28.58	50.80	TF-73	SSM-51
FLEL-2020M3B	930020M16B	FL_-3R	20	20	125	5.33	28.58	50.80	TF-72	SSM-51
FLER-2525M3D	931025M16D	FL_-3L	25	25	150	5.33	31.75	50.80	TF-73	SSM-51
FLEL-2525M3D	930025M16D	FL_-3R	25	25	150	5.33	31.75	50.80	TF-72	SSM-51
FLER-3232M3D	931032M16D	FL_-3L	32	32	170	5.33	38.10	50.80	TF-73	SSM-51
FLEL-3232M3D	930032M16D	FL_-3R	32	32	170	5.33	38.10	50.80	TF-72	SSM-51
FLER-2525M4D	931025M20D	FL_-4L	25	25	150	7.37	34.93	50.80	TF-73	SSM-51
FLEL-2525M4D	930025M20D	FL_-4R	25	25	150	7.37	34.93	50.80	TF-72	SSM-51
FLER-3232M4D	931032M20D	FL_-4L	32	32	170	7.37	41.28	50.80	TF-73	SSM-51
FLEL-3232M4D	930032M20D	FL_-4R	32	32	170	7.37	41.28	50.80	TF-72	SSM-51
FLER-3232M5D	931032M24D	FL_-5L	32	32	170	7.37	50.80	50.80	TF-81	SM-352
FLEL-3232M5D	930032M24D	FL_-5R	32	32	170	7.37	50.80	50.80	TF-80	SM-352
FLER-3232M6D	931032M28D	FL_-6L	32	32	170	7.37	41.28	50.80	TF-121	SSM-51
FLEL-3232M6D	930032M28D	FL_-6R	32	32	170	7.37	41.28	50.80	TF-120	SSM-51

* C&F measured over sharp point of grooving insert

FLO-LOCK

EXTERNAL HOLDER

FLASR/L

Threading and Grooving

Design for Swiss machines

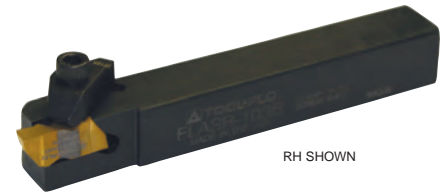
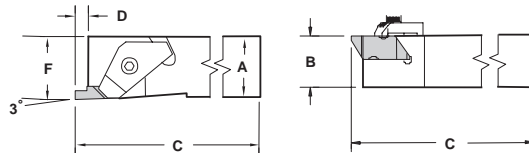

Coolant fed clamps available (See TF-CP clamps on page 106)

Description	EDP Code	Insert	A	B	C	D	F	Clamp	Clamp Screw
FLASR-1010M2D	92901010M08D	FL_-2R	10	10	150	3.51	9.53	TF-182	SM-310
FLASL-1010M2D	92651010M08D	FL_-2L	10	10	150	3.51	9.53	TF-183	SM-310
FLASR-1212M2D	92901212M08D	FL_-2R	12	12	150	3.51	12.70	TF-182	SM-310
FLASL-1212M2D	92651212M08D	FL_-2L	12	12	150	3.51	12.70	TF-183	SM-310
FLASR-1616M2B	92901616M08B	FL_-2R	16	16	125	3.51	15.88	TF-184	SSM-51
FLASL-1616M2B	92651616M08B	FL_-2R	16	16	125	3.51	15.88	TF-184	SSM-51
FLASR-1616M3B	9290616M16B	FL_-3R	16	16	125	5.33	15.88	TF-184	SSM-51
FLASL-1616M3B	9289616M16B	FL_-3L	16	16	125	5.33	15.88	TF-185	SSM-51

* *F* Dim. over sharp point of grooving insert.

EXTERNAL HOLDER

FLRR/L

Undercutting

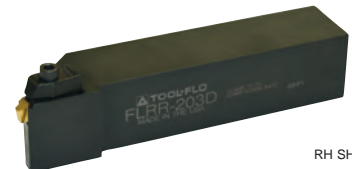
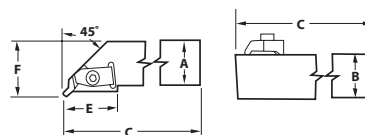

Coolant fed clamps available (See TF-CP clamps on page 106)

Description	EDP Code	Insert	A	B	C	E	F	Clamp	Clamp Screw
FLRR-2020M3B	932020M16B	FLU-3L	20	20	125	31.75	25.40	TF-73	SSM-51
FLRL-2020M3B	931820M16B	FLU-3R	20	20	125	31.75	25.40	TF-72	SSM-51
FLRR-2525M3D	932025M16D	FLU-3L	25	25	150	31.75	31.75	TF-73	SSM-51
FLRL-2525M3D	931825M16D	FLU-3R	25	25	150	31.75	31.75	TF-72	SSM-51
FLRR-3232M3D	932032M16D	FLU-3L	32	32	170	31.75	38.10	TF-73	SSM-51
FLRL-3232M3D	931832M16D	FLU-3R	32	32	170	31.75	38.10	TF-72	SSM-51



INTERNAL HOLDER

A_M-FLER/L

Threading and Grooving
Coolant hole

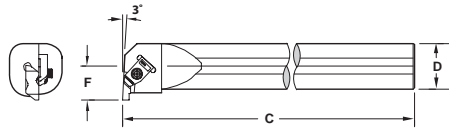

Description	EDP Code	Insert	Min. Bore	D	C	F	Clamp	Clamp Screw
A12M-FLER2	96441208	FL-2L	18.54	12	150	11.10	TF-147	SM-310
A12M-FLEL2	96451208	FL-2R	18.54	12	150	11.10	TF-146	SM-310
A16M-FLER2	96441608	FL-2L	25.40	16	250	12.70	TF-75	SM-310
A16M-FLEL2	96451608	FL-2R	25.40	16	250	12.70	TF-74	SM-310
A20M-FLER2	96442008	FL-2L	28.58	20	250	14.27	TF-75	SM-310
A20M-FLEL2	96452008	FL-2R	28.58	20	250	14.27	TF-74	SM-310
A25M-FLER2	96442508	FL-2L	34.93	25	300	17.48	TF-75	SM-310
A25M-FLEL2	96452508	FL-2R	34.93	25	300	17.48	TF-74	SM-310
A25M-FLER3	96442516	FL-3L	34.93	25	300	17.48	TF-73	SSM-51
A25M-FLEL3	96452516	FL-3R	34.93	25	300	17.48	TF-72	SSM-51
A32M-FLER3	96443216	FL-3L	44.45	32	350	22.23	TF-73	SSM-51
A32M-FLEL3	96453216	FL-3R	44.45	32	350	22.23	TF-72	SSM-51
A40M-FLER3	96444016	FL-3L	50.80	40	350	25.40	TF-73	SSM-51
A40M-FLEL3	96454016	FL-3R	50.80	40	350	25.40	TF-72	SSM-51
A44M-FLER3	96444416	FL-3L	57.15	44	350	28.58	TF-73	SSM-51
A50M-FLER3	96445016	FL-3L	63.50	50	400	31.75	TF-73	SSM-51
A50M-FLEL3	96455016	FL-3R	63.50	50	400	31.75	TF-72	SSM-51
A40M-FLER4	96444020	FL-4L	57.15	40	350	31.75	TF-73	SSM-51
A40M-FLEL4	96454020	FL-4R	57.15	40	350	31.75	TF-72	SSM-51
A50M-FLER4	96445020	FL-4L	69.85	50	400	32.92	TF-73	SSM-51
A50M-FLEL4	96455020	FL-4R	69.85	50	400	32.92	TF-72	SSM-51
A50M-FLER5	96445024	FL-5L	71.42	50	400	35.71	CM-81	SM-352
A50M-FLER6	96445028	FL-6L	69.85	50	400	34.93	CM-121	SSM-51

*F" and "C" Dim. over sharp point of grooving insert.

FLO-LOCK

EXTERNAL HOLDER

FLSR/LT

For double ended FLGT/FLRT inserts
Inch

Exclusive TOOL-FLO design!

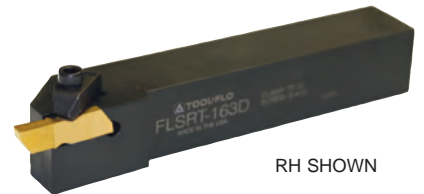
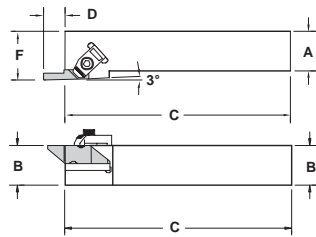

Coolant fed clamps available (See TF-CP clamps on page 106)

Description	EDP Code	Insert	A	B	C	D	F	Clamp	Clamp Screw
FLSRT-2525M3	934325M16	FL_T-3R	25	25	152	11,2	40,18	TF-72	SSM-51
FLSLT-2525M3	934225M16	FL_T-3L	25	25	152	11,2	40,18	TF-73	SSM-51
FLSRT-3232M3	934332M16	FL_T-3R	32	32	152	11,2	46,53	TF-72	SSM-51
FLSLT-3232M3	934232M16	FL_T-3L	32	32	152	11,2	46,53	TF-73	SSM-51
FLSRT-2525M4	934325M20	FL_T-4R	25	25	152	14,2	40,18	TF-72	SSM-51
FLSLT-2525M4	934225M20	FL_T-4L	25	25	152	14,2	40,18	TF-73	SSM-51
FLSRT-3232M4	934332M20	FL_T-4R	32	32	152	14,2	46,53	TF-72	SSM-51
FLSLT-3232M4	934232M20	FL_T-4L	32	32	152	14,2	46,53	TF-73	SSM-51

FLER/LT

For double ended FLGT/FLRT inserts

Exclusive TOOL-FLO design!

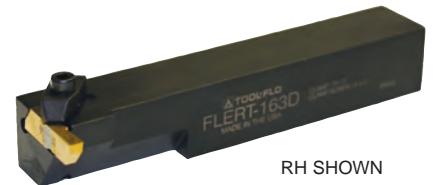
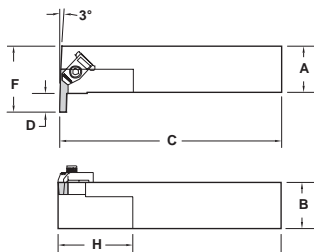

Coolant fed clamps available
(See TF-CP clamps on page 106)

Description	EDP Code	Insert	A	B	C	D	F	Clamp	Clamp Screw
FLERT-2525M3	931125M16	FL_T-3L	25	25	150	11,18	40,18	TF-72	SSM-51
FLELT-2525M3	930125M16	FL_T-3R	25	25	150	11,18	40,18	TF-73	SSM-51
FLERT-3232M3	931132M16	FL_T-3L	32	32	170	11,18	46,53	TF-72	SSM-51
FLELT-3232M3	930132M16	FL_T-3R	32	32	170	11,18	46,53	TF-73	SSM-51
FLERT-2525M4	931125M20	FL_T-4L	25	25	150	14,22	40,18	TF-72	SSM-51
FLELT-2525M4	930125M20	FL_T-4R	25	25	150	14,22	40,18	TF-73	SSM-51
FLERT-3232M4	931132M20	FL_T-4L	32	32	170	14,22	46,53	TF-72	SSM-51
FLELT-3232M4	930132M20	FL_T-4R	32	32	170	14,22	46,53	TF-73	SSM-51



INTERNAL BAR A_FLER/LT

For double ended FLGT/FLRT inserts
Inch

Exclusive TOOL-FLO design!

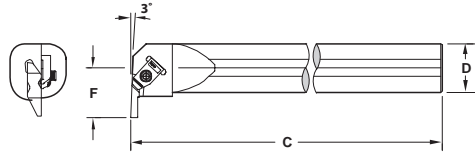

Description	EDP Code	Insert	D	C	F	Min. Bore	Clamp	Clamp Screw
A32M-FLERT3	96442016	FL_T-3L	32	450	27.48	46.00	TF-72	SSM-51
A32M-FLELT3	96432016	FL_T-3R	32	450	27.48	46.00	TF-73	SSM-51
A40M-FLERT3	96442416	FL_T-3L	40	450	31.60	54.15	TF-72	SSM-51
A40M-FLELT3	96432416	FL_T-3R	40	450	31.60	54.15	TF-73	SSM-51
A50M-FLERT4	96442820	FL_T-4L	50	450	40.87	68.43	TF-72	SSM-51
A50M-FLELT4	96432820	FL_T-4R	50	450	40.87	68.43	TF-73	SSM-51

INTERCHANGEABLE HEADS H-FLER

Threading and Grooving

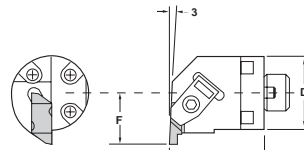

PARTS

Description	EDP Code	Insert	D	C	F	Min. Bore	Clamp	Clamp Screw
H32M-FLER3W	935032M16W	FL-3L	32	40	22.23	44.45	TF-73	SSM-51
H40M-FLER3W	935040M16W	FL-3L	40	40	25.40	50.80	TF-73	SSM-51
H44M-FLER3W	935044M16W	FL-3L	44	40	28.58	57.15	TF-73	SSM-51
H50M-FLER3W	935050M16W	FL-3L	50	40	31.75	63.50	TF-73	SSM-51
H67M-FLER3W	935067M16W	FL-3L	67	40	38.10	76.20	TF-73	SSM-51
H40M-FLER4W	935040M20W	FL-4L	40	40	31.75	63.50	TF-73	SSM-51
H50M-FLER4W	935050M20W	FL-4L	50	40	34.93	69.85	TF-73	SSM-51
H60M-FLER4W	935060M20W	FL-4L	60	40	38.10	76.20	TF-73	SSM-51
H67M-FLER4W	935067M20W	FL-4L	67	40	41.28	82.55	TF-73	SSM-51
H40M-FLER6W	935040M28W	FL-6L	40	40	31.75	63.50	TF-121	SSM-51
H50M-FLER6W	935050M28W	FL-6L	50	40	34.93	69.85	TF-121	SSM-51
H67M-FLER6W	935067M28W	FL-6L	67	40	41.28	82.55	TF-121	SSM-51

*Left hand quoted on request

HS-FLEL/R*

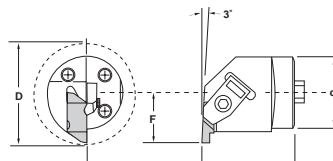

PARTS

Description	EDP Code	Insert	d	C	F	Min. Bore (D)	Clamp	Clamp Screw
HS32-FLER3W	9IHS65032M16	FL-3L	32	34.04	22.00	43.94	TF-73	SSM-51
HS40-FLER3W	9IHS65040M16	FL-3L	40	40.13	27.99	56.13	TF-73	SSM-51
HS50-FLER3W	9IHS65050M16	FL-3L	50	41.91	35.05	70.10	TF-73	SSM-51
HS60-FLER3W	9IHS65060M16	FL-3L	60	44.45	44.20	88.39	TF-73	SSM-51
HS50-FLER4W	9IHS65050M20	FL-4L	50	41.91	35.05	70.10	TF-73	SSM-51
HS60-FLER4W	9IHS65060M20	FL-4L	60	44.45	44.20	88.39	TF-73	SSM-51

*Left hand quoted on request.

Flo-Lock Series Kits

THREADING KITS

V-THREADING
KIT #1MA

Kit Contents

1	FLSR-2525M3D
4	FLT-3R-HCB GP50
1	SSM51 SCREW

V-THREADING
KIT #1MB

Kit Contents

1	FLSR-2525M3D
4	FLT-3R-HCB GP3
1	SSM51 SCREW

GROOVING KITS

W 300mm GROOVING
KIT #2MA

Kit Contents

1	FLSR-2525M3D
4	FLG-3M300R-CB GP50
1	SSM51 SCREW

W 300mm GROOVING
KIT #2MB

Kit Contents

1	FLSR-2525M3D
4	FLG-3M300R-CB GP3
1	SSM51 SCREW

W 250mm GROOVING
KIT #3MA

Kit Contents

1	FLSR-2525M3D
4	FLG-3M250R-CB GP50
1	SSM51 SCREW

W 250mm GROOVING
KIT #3MB

Kit Contents

1	FLSR-2525M3D
4	FLG-3M250R-CB GP3
1	SSM51 SCREW

W 175mm GROOVING
KIT #4MA

Kit Contents

1	FLSR-2525M3D
4	FLG-3M175R-CB GP50
1	SSM51 SCREW

W 175mm GROOVING
KIT #4MB

Kit Contents

1	FLSR-2525M3D
4	FLG-3M175R-CB GP3
1	SSM51 SCREW

W 150mm GROOVING
KIT #5MA

Kit Contents

1	FLSR-2525M3D
4	FLG-3M150R-CB GP50
1	SSM51 SCREW

W 150mm GROOVING
KIT #5MB

Kit Contents

1	FLSR-2525M3D
4	FLG-3M150R-CB GP3
1	SSM51 SCREW

DEEP GROOVING KITS

W 300mm GROOVING
KIT #6M

Kit Contents

1	FLSR-2525M3D
4	FLGD-3M300R-CB AC3
1	SSM51 SCREW

W 250mm GROOVING
KIT #7M

Kit Contents

1	FLSR-2525M3D
4	FLGD-3M250R-CB AC3
1	SSM51 SCREW





Coolant-Fed Clamps

Patent pending

Can be used with low pressure or high pressure coolant (rated up to 1500 psi)

• Available for #2, 3 & 4 Flo-Lock right and left hand inserts

• Fits other brand's standard holders

• Available in 6 and 12 pack quantities for an added cost savings!



FLO-LOCK

Use Your Existing Holders!

Simply replace the top clamp on your standard holder.

6mm High Pressure Coolant Kit

6MM COOLANT KIT HIGH PRESSURE
EDP code: 9HCPKIT6MHP

Kit comes complete with:

1 pc	M6X1 Elbow Coolant Fitting
1 pc	M6x1 Straight Coolant Fitting
1 pc	.125 (1/8")x1 Elbow Coolant Fitting
1 pc	.125 (1/8")x1 Straight Coolant Fitting
1 pc	6mm High Pressure Coolant Hose

Clamp not included. Sold separately.

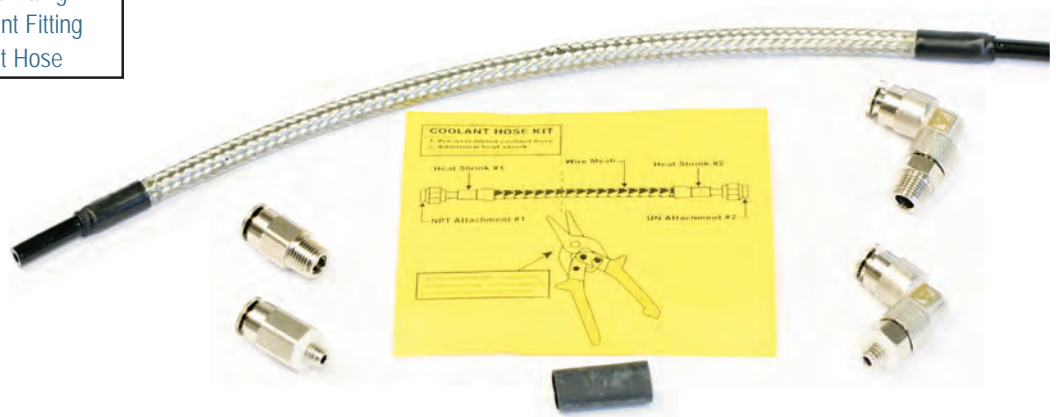



Coolant Fed Clamps

For FLSR/L and FLASR holders

TF-CP

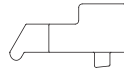
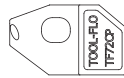

TF72CP shown

Clamp	EDP Code	Toolholder	Insert
TF72CP	9HTF72CP	FLSR-__3/4	FL_-3R/4R
TF73CP	9HTF73CP	FLSL-__3/4	FL_-3L/4L
TF74CP	9HTF74CP	FLSR-__2	FL_-2R
TF75CP	9HTF75CP	FLSL-__2	FL_-2L
TF182CP	9HTF182CP	FLASR-__2	FL_-2R
TF184CP	9HTF183CP	FLASR-__3	FL_-3R

Fittings

6mm & 1/8"



M6 x 1 elbow
(Connection to machine)



M6 x 1 straight
(Connection to machine)



1/8" (.125) NPT elbow
(Connection to clamp)



1/8" (.125) NPT straight
(Connection to clamp)

Description	EDP Code	Fitting/Thread size
M6X1 ELBOW COOLANT FITTING	9HCPM6X190	6mm x 1.0 (Connection to machine)
M6X1 STRAIGHT COOLANT FITTING	9HCPM6X1	6mm x 1.0 (Connection to machine)
1/8" NPT ELBOW COOLANT FITTING	9HCP12590NPT	1/8" (.125) x 27 NPT (Connection to clamp)
1/8" NPT STRAIGHT COOLANT FITTING	9HCP125NPT	1/8" (.125) x 27 NPT (Connection to clamp)

High Pressure Coolant Hose

6mm

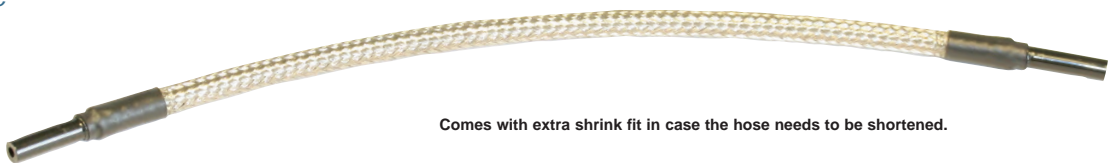

Comes with extra shrink fit in case the hose needs to be shortened.

Description	EDP Code	Size	Length
6MM HIGH PRESSURE COOLANT HOSE	9HCP6MHOSEHP	6mm	12"



American Standard Buttress Thread Designations

- When only the designation BUTT is used, the thread is a “pull” type buttress (external thread pulls) with the clearance flank (45°) leading and the pressure flank (7°) following.
- When the designation PUSH-BUTT is used, the thread is a push type buttress (external thread pushes) with the load flank (7°) leading and the 45° clearance flank following.
- Whenever possible this description should be confirmed by a simplified view showing thread angles on the drawing of the product that has the buttress thread.
- Always remember that the position of your holder and direction of your feed will determine the lead angle on the insert.

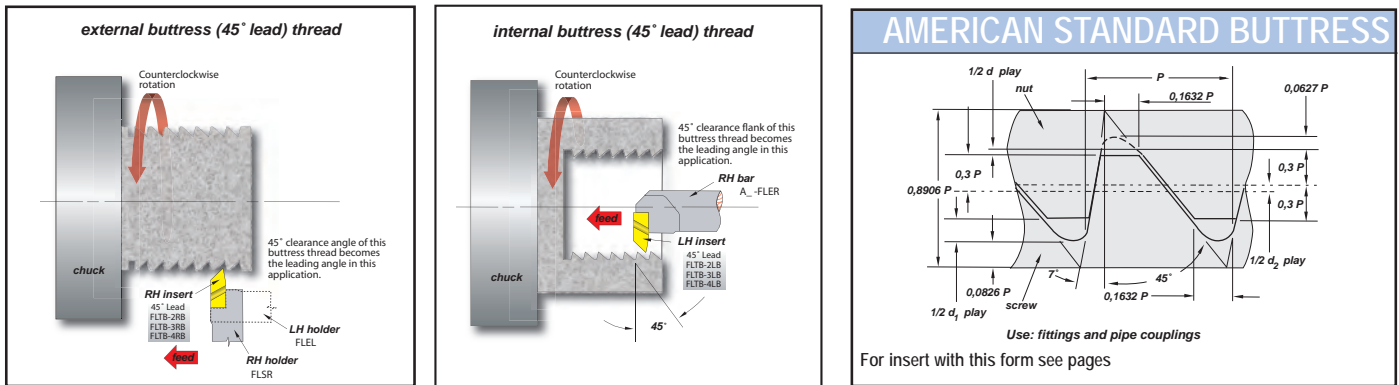

FLO-LOCK

Threading Limits with Standard Flo-Lock Inserts

The following charts list the largest pitch that can be applied on internal applications for Buttress Threading Flo-Lock inserts in sizes 2, 3, 4 and 6.

FLTB-2A & 2B	internal threading limitations	
threads per inch	nominal thread size	minimum minor diameter
8	1-3/4	40.64
10	1-5/8	38.23
12	1-1/2	35.56
16	1-1/4	29.85
20	1-1/16	25.45

FLTB-3A & 4A	internal threading limitations	
threads per inch	nominal thread size	minimum minor diameter
4*	2-1/2	55.88
5	2-1/4	51.05
6	2	45.72
8	1-3/4	40.64
10	1-5/8	38.23
12**	1-1/2	35.56

* FLTB-4A insert only
** Sixteen or 20 threads per inch can be cut providing minor diameter is 1.375 or larger.

FLTB-3B & 4B	internal threading limitations	
threads per inch	nominal thread size	minimum minor diameter
4	*2-7/8	65.41
5	2-3/4	63.75
6	2-3/8	55.25
8	2-1/8	50.17
10	1-7/8	44.58
12	1-5/8	38.74
16	1-1/2	35.74
20	1-7/16	35.00

* FLTB-4B insert only

Feed direction towards the chuck

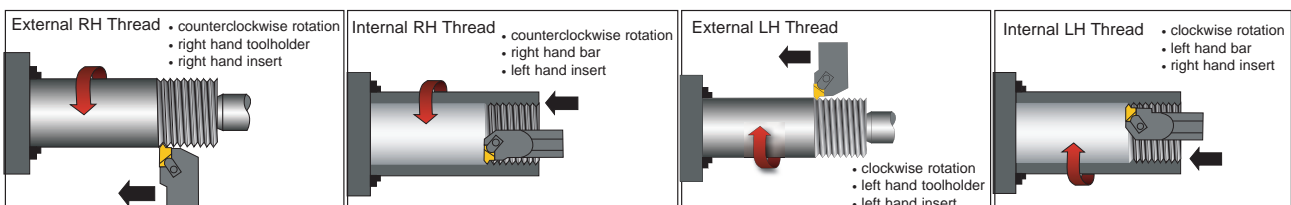

Feed direction towards the tailstock

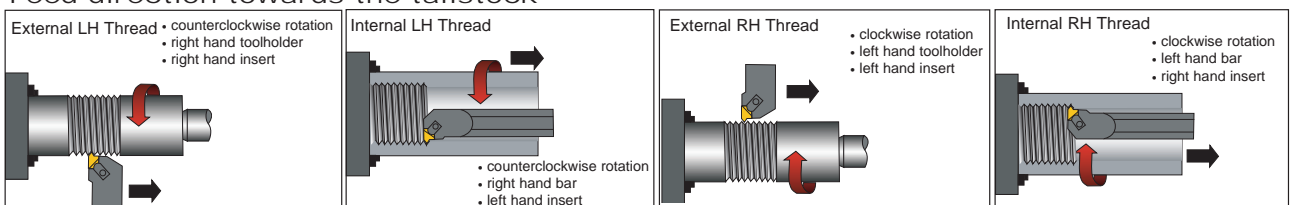



Threading Limits with Standard Flo-Lock Inserts

The following charts list the largest pitch that can be applied on internal applications for Acme and V-Threading Flo-Lock inserts in sizes 2,3, 4 and 6. For Buttress threads, please see previous page.

60° V-Threading Limits

FLT-2 Inserts internal threading limitations		
threads per inch	nominal thread size	minimum minor diameter
6	1-7/8	43.05
7	1-3/4	40.51
8	1-5/8	37.85
9	1-9/16	36.63
10	1-1/2	35.36
11	1-7/16	34.01
12	1-3/8	32.64
13	1-5/16	31.22
14	1-1/4	29.79
16	1-1/4	30.02
18	1-1/8	27.05
20	1-1/8	27.20
24	1-1/16	25.83

* 24 TPI and finer can be cut with a #2 series insert provided that the minor diameter is 1.000 or larger.

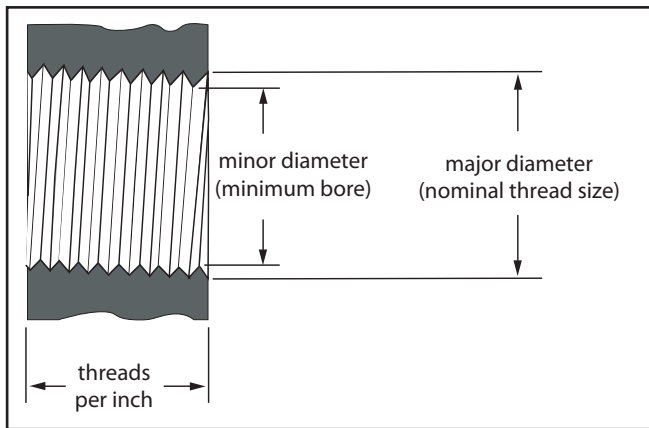

FLT-3 & 4 Inserts internal threading limitations		
threads per inch	nominal thread size	minimum minor diameter
4**	3	69.32
4-1/2**	2-7/8	66.90
5	2-3/4	64.36
6	2-1/2	58.93
7	2-1/4	53.21
8	2	47.37
9	1-15/16	46.15
10	1-7/8	44.88
11	1-13/16	43.54
12	1-3/4	42.16
13	1-5/8	39.17
14	1-9/16	37.72
16*	1-7/16	34.80

*16 pitch V threads and finer can be cut provided the minor diameter is 1.370 or larger.
**FLT-4 only.

Acme Threading Limits

FLA-2 internal threading limitations		
threads per inch	nominal thread size	minimum minor diameter
6	2-1/2	59.26
8	2-1/4	53.98
10	2	48.26
12	1-3/4	42.34
14	1-5/8	39.47
16*	1-1/2	36.53

*16 pitch acme threads and finer can be cut provided the minor diameter is 1.438 or larger.

FLA-3, 4 & 6 internal threading limitations		
threads per inch	nominal thread size	minimum minor diameter
2**	5	114.30
2-1/2**	4-1/2	104.14
3**	4	93.09
4	3-1/2	82.55
5	3	71.12
6	2-1/2	59.26
8	2-1/4	53.98
10	2	48.26
12	1-3/4	42.34
14	1-5/8	39.47
16*	1-1/2	36.53

*16 pitch acme threads and finer can be cut provided the minor diameter is 1.438 or larger.
**FLA-6 only.

NOTE: Positive rake acme inserts are recommended for stainless steels and high-temp alloy applications. Quoted upon request.

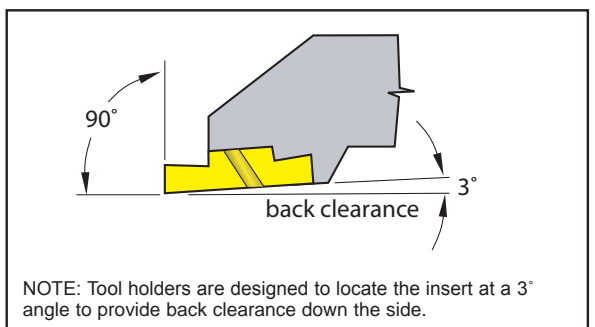
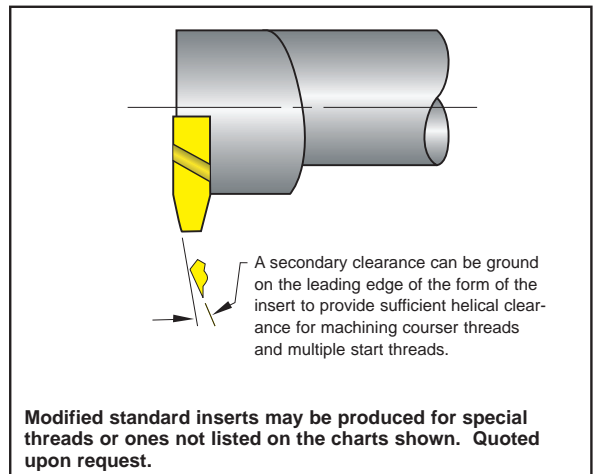

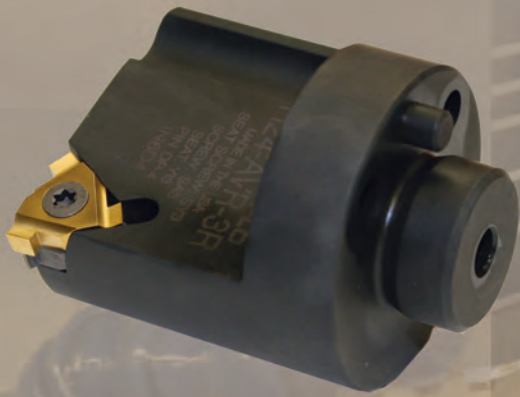

TOOL-FLO
CR-5B75-4E
TF22675 G50

TOOL-FLO
CR-5B75-4E
TF193511-10P

TOOL-FLO
CR-5B75-4E
TF193511-10P

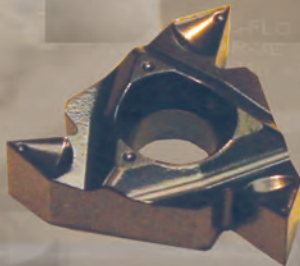

LAYDOWN

Threading & Grooving



LT Style Laydown Insert Nomenclature Chart

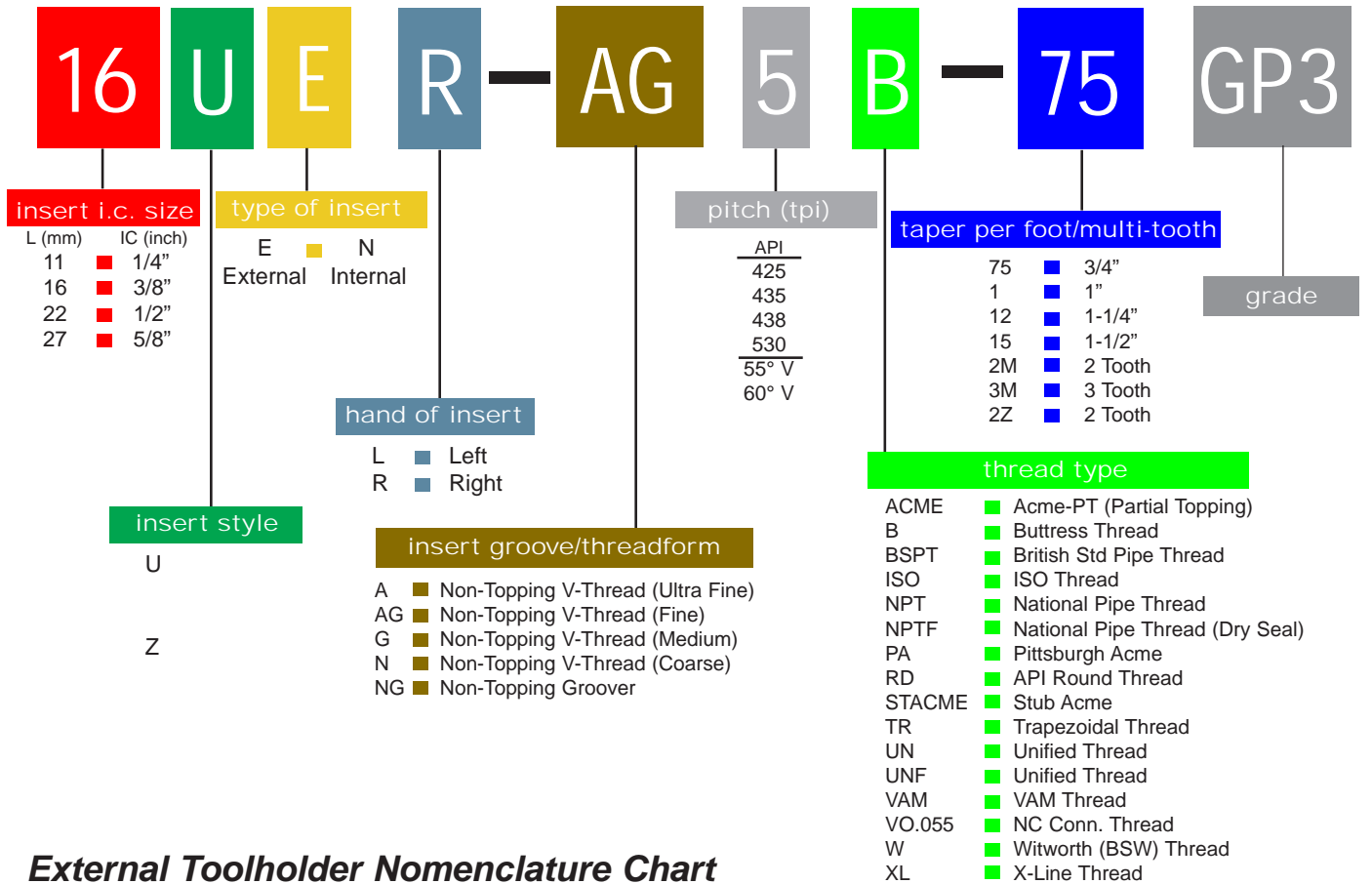

External Toolholder Nomenclature Chart

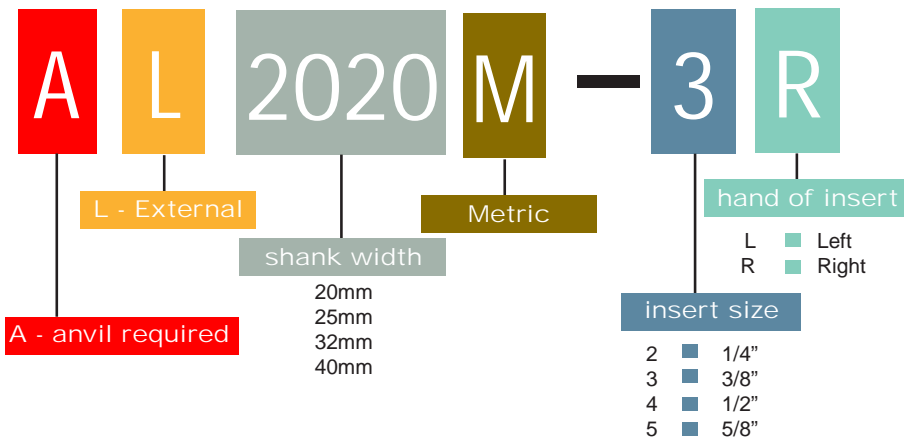

Internal Bar Nomenclature Chart

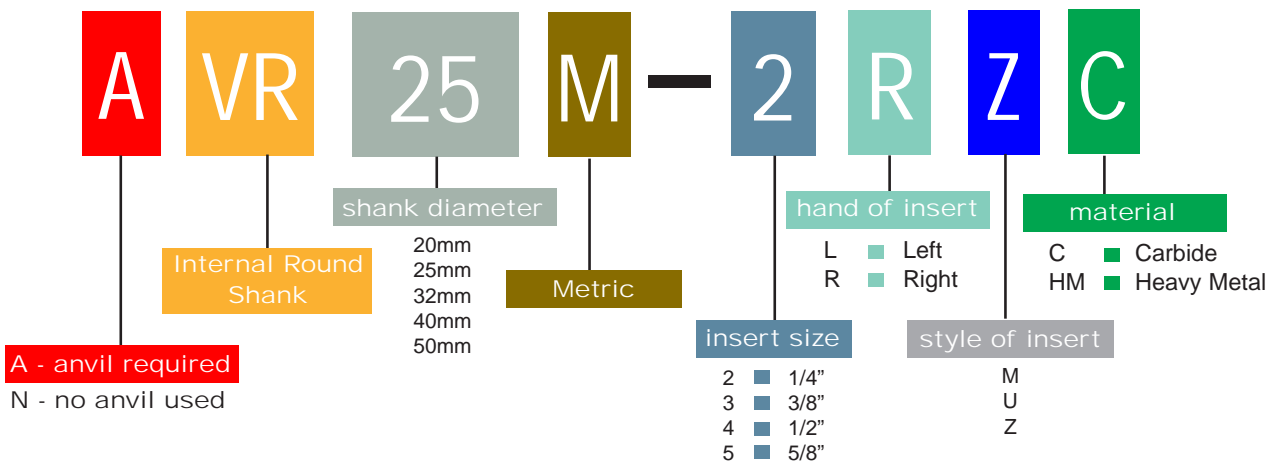



LAYDOWN

ACME

16, 22 & 27NR/ER - 3/8", 1/2", 5/8" I.C.

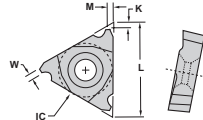

INT RH SHOWN
EXT OPPOSITE



Description	EDP Code	TPI	W	IC	L	M	K	TIN Coated		AlTiN Coated		
								GP22	GP50	AC22	AC3	AC50
16ER 16ACME-PT	5006216PT	16	0.52	3/8	16.00	1.02	1.02	●	●	●	●	●
16EL 16ACME-PT	5046216PT	16	0.52	3/8	16.00	1.02	1.02	●	●	●	●	●
16ER 14ACME-PT	5006214PT	14	0.61	3/8	16.00	1.27	1.02	●	●	●	●	●
16EL 14ACME-PT	5046214PT	14	0.61	3/8	16.00	1.27	1.02	●	●	●	●	●
16ER 12ACME-PT	5006212PT	12	0.72	3/8	16.00	1.27	1.02	●	●	●	●	●
16EL 12ACME-PT	5046212PT	12	0.72	3/8	16.00	1.27	1.02	●	●	●	●	●
16ER 10ACME-PT	5006210PT	10	0.81	3/8	16.00	1.52	1.27	●	●	●	●	●
16EL 10ACME-PT	5046210PT	10	0.81	3/8	16.00	1.52	1.27	●	●	●	●	●
16ER 8ACME-PT	5006208PT	8	1.04	3/8	16.00	1.52	1.52	●	●	●	●	●
16EL 8ACME-PT	5046208PT	8	1.04	3/8	16.00	1.52	1.52	●	●	●	●	●
22ER 6ACME-PT	5106206PT	6	1.44	1/2	22.10	2.03	1.78	●	●	●	●	●
22EL 6ACME-PT	5146206PT	6	1.44	1/2	22.10	2.03	1.78	●	●	●	●	●
22ER 5ACME-PT	5106205PT	5	1.75	1/2	22.10	2.29	2.03	●	●	●	●	●
22EL 5ACME-PT	5146205PT	5	1.75	1/2	22.10	2.29	2.03	●	●	●	●	●
27ER 4ACME-PT	5206204PT	4	2.22	5/8	26.92	2.79	2.29	●	●	●	●	●
27EL 4ACME-PT	5246204PT	4	2.22	5/8	26.92	2.79	2.29	●	●	●	●	●
16NR 16ACME-PT	5026216PT	16	0.52	3/8	16.00	1.02	1.02	●	●	●	●	●
16NL 16ACME-PT	5066216PT	16	0.52	3/8	16.00	1.02	1.02	●	●	●	●	●
16NR 14ACME-PT	5026214PT	14	0.61	3/8	16.00	1.27	1.02	●	●	●	●	●
16NL 14ACME-PT	5066214PT	14	0.61	3/8	16.00	1.27	1.02	●	●	●	●	●
16NR 12ACME-PT	5026212PT	12	0.72	3/8	16.00	1.27	1.27	●	●	●	●	●
16NL 12ACME-PT	5066212PT	12	0.72	3/8	16.00	1.27	1.27	●	●	●	●	●
16NR 10ACME-PT	5026210PT	10	0.81	3/8	16.00	1.27	1.27	●	●	●	●	●
16NL 10ACME-PT	5066210PT	10	0.81	3/8	16.00	1.27	1.27	●	●	●	●	●
16NR 8ACME-PT	5026208PT	8	1.04	3/8	16.00	1.52	1.52	●	●	●	●	●
16NL 8ACME-PT	5066208PT	8	1.04	3/8	16.00	1.52	1.52	●	●	●	●	●
22NR 6ACME-PT	5126206PT	6	1.44	1/2	22.10	2.03	1.78	●	●	●	●	●
22NL 6ACME-PT	5166206PT	6	1.44	1/2	22.10	2.03	1.78	●	●	●	●	●
22NR 5ACME-PT	5126205PT	5	1.75	1/2	22.10	2.29	2.03	●	●	●	●	●
22NL 5ACME-PT	5166205PT	5	1.75	1/2	22.10	2.29	2.03	●	●	●	●	●
27NR 4ACME-PT	5226204PT	4	2.22	5/8	26.92	2.54	2.29	●	●	●	●	●
27NL 4ACME-PT	5266204PT	4	2.22	5/8	26.92	2.54	2.29	●	●	●	●	●

LAYDOWN

ACME STUB

16, 22 & 27NR/ER - 3/8", 1/2", 5/8" I.C.

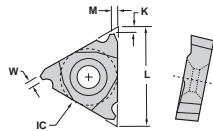

INT RH SHOWN
EXT OPPOSITE



Description	EDP Code	TPI	W	IC	L	M	K	TIN Coated		AlTiN Coated		
								GP22	GP50	AC22	AC3	AC50
16ER 16STACME-PT	5006416PT	16	0.60	3/8	16.00	1.02	1.02	●	●	●	●	●
16EL 16STACME-PT	5046416PT	16	0.60	3/8	16.00	1.02	1.02	●	●	●	●	●
16ER 14STACME-PT	5006414PT	14	0.70	3/8	16.00	1.02	1.02	●	●	●	●	●
16EL 14STACME-PT	5046414PT	14	0.70	3/8	16.00	1.02	1.02	●	●	●	●	●
16ER 12STACME-PT	5006412PT	12	0.83	3/8	16.00	1.27	1.27	●	●	●	●	●
16EL 12STACME-PT	5046412PT	12	0.83	3/8	16.00	1.27	1.27	●	●	●	●	●
16ER 10STACME-PT	5006410PT	10	0.94	3/8	16.00	1.27	1.27	●	●	●	●	●
16EL 10STACME-PT	5046410PT	10	0.94	3/8	16.00	1.27	1.27	●	●	●	●	●
16ER 8STACME-PT	5006408PT	8	1.21	3/8	16.00	1.52	1.52	●	●	●	●	●
16EL 8STACME-PT	5046408PT	8	1.21	3/8	16.00	1.52	1.52	●	●	●	●	●
22ER 6STACME-PT	5106406PT	6	1.66	1/2	22.10	1.78	1.78	●	●	●	●	●
22EL 6STACME-PT	5146406PT	6	1.66	1/2	22.10	1.78	1.78	●	●	●	●	●
22ER 5STACME-PT	5106405PT	5	2.01	1/2	22.10	2.03	2.03	●	●	●	●	●
22EL 5STACME-PT	5146405PT	5	2.01	1/2	22.10	2.03	2.03	●	●	●	●	●
27ER 4STACME-PT	5206404PT	4	2.55	5/8	26.92	2.29	2.79	●	●	●	●	●
27EL 4STACME-PT	5246404PT	4	2.55	5/8	26.92	2.29	2.79	●	●	●	●	●
16NR 16STACME-PT	5026416PT	16	0.60	3/8	16.00	1.02	1.02	●	●	●	●	●
16NL 16STACME-PT	5066416PT	16	0.60	3/8	16.00	1.02	1.02	●	●	●	●	●
16NR 14STACME-PT	5026414PT	14	0.70	3/8	16.00	1.02	1.02	●	●	●	●	●
16NL 14STACME-PT	5066414PT	14	0.70	3/8	16.00	1.02	1.02	●	●	●	●	●
16NR 12STACME-PT	5026412PT	12	0.83	3/8	16.00	1.27	1.02	●	●	●	●	●
16NL 12STACME-PT	5066412PT	12	0.83	3/8	16.00	1.27	1.02	●	●	●	●	●
16NR 10STACME-PT	5026410PT	10	0.94	3/8	16.00	1.27	1.27	●	●	●	●	●
16NL 10STACME-PT	5066410PT	10	0.94	3/8	16.00	1.27	1.27	●	●	●	●	●
16NR 8STACME-PT	5026408PT	8	1.21	3/8	16.00	1.52	1.52	●	●	●	●	●
16NL 8STACME-PT	5066408PT	8	1.21	3/8	16.00	1.52	1.52	●	●	●	●	●
22NR 6STACME-PT	5126406PT	6	1.66	1/2	22.10	1.78	1.78	●	●	●	●	●
22NL 6STACME-PT	5166406PT	6	1.66	1/2	22.10	1.78	1.78	●	●	●	●	●
22NR 5STACME-PT	5126405PT	5	2.01	1/2	22.10	2.29	2.03	●	●	●	●	●
22NL 5STACME-PT	5166405PT	5	2.01	1/2	22.10	2.29	2.03	●	●	●	●	●
27NR 4STACME-PT	5226404PT	4	2.55	5/8	26.92	2.29	2.29	●	●	●	●	●
27NL 4STACME-PT	5266404PT	4	2.55	5/8	26.92	2.29	2.29	●	●	●	●	●

In an effort to improve our stock standard grade offering, there are periodic changes. Please see current price list for up to date grade offering.

● High performance choice in optimal conditions.
▲ Recommended grade under general conditions

Cast Iron	▲	●	●	●
Non-Ferrous	▲	●	●	●
Stainless/High Temp	▲	●	●	●
Steel	▲	●	●	●



API BUTTRESS 22NR/ER - 1/2" I.C.

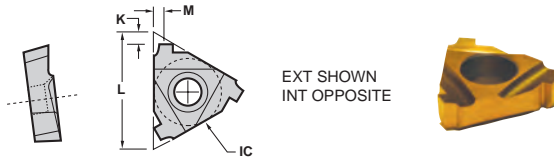

Description	EDP Code	TPI	TPF	IC	L	M	K	Conn. No.	TIN Coated		AITTN Coated		
									GP22	GP50	AC22	AC3	AC50
22ER 8B75	5102100	8	3/4	1/2	22.10	2.59	1.85	U.S. Improved Buttress	●	●	●	●	●
22ER 5B75	5101600	5	3/4	1/2	22.10	2.21	2.21	4-1/2 - 13-3/8	●	●	●	●	●
22ER 5B1	5101700	5	1	1/2	22.10	2.41	2.21	16 and larger	●	●	●	●	●
22NR 8B75	5122100	8	3/4	1/2	22.10	2.59	1.85	U.S. Improved Buttress	●	●	●	●	●
22NR 5B75	5121600	5	3/4	1/2	22.10	2.06	2.21	4-1/2 - 13-3/8	●	●	●	●	●
22NR 5B1	5121700	5	1	1/2	22.10	2.06	2.29	16 and larger	●	●	●	●	●

API ROTARY SHOULDER CONNECTION 22 & 27NR/ER - 1/2" & 5/8" I.C.

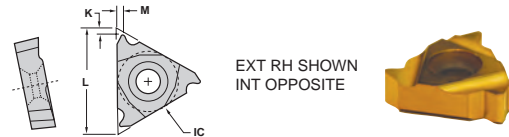

Description	EDP Code	TPI	TPF	IC	L	M	K	Conn. No.	TIN Coated		AITTN Coated		
									GP22	GP50	AC22	AC3	AC50
22ER 530	5101300	5	3	1/2	22.10	2.54	2.03	3-1/2FH, 2-3/8, 4-1/2 Reg.	●	●	●	●	●
22ER 4PAC	5101500	4	1-1/2	1/2	22.10	2.79	2.03	American Open Hole	●	●	●	●	●
22ER 438	5101200	4	3	1/2	22.10	2.79	2.79	NC56 - NC71	●	●	●	●	●
22ER 435	5101100	4	3	1/2	22.10	2.79	2.03	5-1/2, 7-5/8, 8-5/8 Reg.	●	●	●	●	●
22ER 42F*	5101400	4	2	1/2	22.10	2.79	2.03	VO.065*	●	●	●	●	●
22ER 428	5101000	4	2	1/2	22.10	2.54	2.03	NC23-NC50, 2-3/8 - 5-1/2IF	●	●	●	●	●
22ER 425	5100900	4	2	1/2	22.10	2.54	2.03	5-1/2, 6-5/8FH, 6-5/8 Reg.	●	●	●	●	●
22NR 530	5121300	5	3	1/2	22.10	2.54	2.03	3-1/2FH, 2-3/8, 4-1/2 Reg.	●	●	●	●	●
22NR 4PAC	5121500	4	1-1/2	1/2	22.10	2.79	2.03	American Open Hole	●	●	●	●	●
22NR 438	5121200	4	3	1/2	22.10	2.79	2.79	NC56 - NC71	●	●	●	●	●
22NR 435	5121100	4	3	1/2	22.10	2.79	2.03	5-1/2, 7-5/8, 8-5/8 Reg.	●	●	●	●	●
22NR 42F*	5121400	4	2	1/2	22.10	2.79	2.03	VO.065*	●	●	●	●	●
22NR 428	5121000	4	2	1/2	22.10	2.54	2.03	NC23-NC50, 2-3/8 - 5-1/2IF	●	●	●	●	●
22NR 425	5120900	4	2	1/2	22.10	2.54	2.03	5-1/2, 6-5/8FH, 6-5/8 Reg.	●	●	●	●	●
27ER 530	5201300	5	3	5/8	3.20	2.79	1.78	3-1/2FH, 2-3/8, 4-1/2 Reg.	●	●	●	●	●
27ER 438	5201200	4	3	5/8	3.20	2.79	2.03	NC56 - NC71	●	●	●	●	●
27ER 435	5201100	4	3	5/8	3.20	3.05	2.03	5-1/2, 7-5/8, 8-5/8 Reg.	●	●	●	●	●
27ER 428	5201000	4	2	5/8	3.20	2.79	2.03	NC23-NC50, 2-3/8 - 5-1/2IF	●	●	●	●	●
27ER 425	5200900	4	2	5/8	3.20	3.05	2.03	5-1/2, 6-5/8FH, 6-5/8 Reg.	●	●	●	●	●
27NR 530	5221300	5	3	5/8	3.20	2.79	2.03	3-1/2FH, 2-3/8, 4-1/2 Reg.	●	●	●	●	●
27NR 438	5221200	4	3	5/8	3.20	2.79	2.03	NC56 - NC71	●	●	●	●	●
27NR 435	5221100	4	3	5/8	3.20	3.05	2.03	5-1/2, 7-5/8, 8-5/8 Reg.	●	●	●	●	●
27NR 428	5221000	4	2	5/8	3.20	2.79	2.03	NC23-NC50, 2-3/8 - 5-1/2IF	●	●	●	●	●
27NR 425	5220900	4	2	5/8	3.20	3.05	2.03	5-1/2, 6-5/8FH, 6-5/8 Reg.	●	●	●	●	●

* Obsolete thread form, See A.P.I. Spec 7, 35th Edition, May 1, 1995, Section 9.4

API ROUND 16NR/ER - 3/8" I.C. w/patented chipbreaker

Exclusive patented chipbreaker!



Description	EDP Code	TPI	IC	L	M	K	Conn. No.	Uncoated		TIN Coated		AITTN Coated		
								C22	GP22	GP50	AC22	AC3	AC50	
16ER 8RD-CB	5003200HC	8	3/8	16.00	1.30	1.50		●	●	●	●	●	●	●
16ER 10RD-CB	5003400HC	10	3/8	16.00	1.19	1.50		●	●	●	●	●	●	●
16NR 8RD-CB	5023200HC	8	3/8	16.00	1.30	1.50		●	●	●	●	●	●	●
16NR 10RD-CB	5023400HC	10	3/8	16.00	1.19	1.50		●	●	●	●	●	●	●

API ROUND 16 & 22NR/ER - 3/8" & 1/2" I.C.

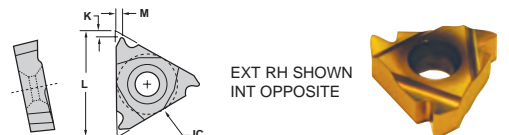

Description	EDP Code	TPI	IC	L	M	K	Conn. No.	TIN Coated		AITTN Coated		
								GP22	GP50	AC22	AC3	AC50
16ER 8RD	5003200	8	3/8	16.51	1.50	1.42		●	●	●	●	●
16ER 10RD	5003400	10	3/8	16.51	1.50	1.42		●	●	●	●	●
22ER 8RD	5103200	8	1/2	22.10	1.52	1.42		●	●	●	●	●
22ER 10RD	5103400	10	1/2	22.10	1.17	1.22		●	●	●	●	●
16NR 8RD	5023200	8	3/8	16.51	1.50	1.42		●	●	●	●	●
16NR 10RD	5023400	10	3/8	16.51	1.50	1.42		●	●	●	●	●
22NR 8RD	5123200	8	1/2	22.10	1.52	1.42		●	●	●	●	●
22NR 10RD	5123400	10	1/2	22.10	1.17	1.22		●	●	●	●	●

In an effort to improve our stock standard grade offering, there are periodic changes. Please see current price list for up to date grade offering.

- High performance choice in optimal conditions.
- ▲ Recommended grade under general conditions.

Material	GP22	GP50	AC22	AC3	AC50
Cast Iron					●
Non-Ferrous					●
Stainless/High Temp					●
Steel			▲		●



LAYDOWN

API ROUND

22 & 27NR/ER - 1/2" & 5/8" I.C.

Multi-tooth

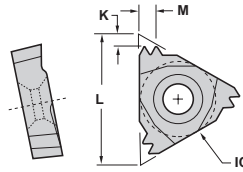

EXT RH SHOWN
INT OPPOSITE



Description	EDP Code	TPI	IC	L	M	K	TIN Coated		AITTN Coated		
							GP22	GP50	AC22	AC3	AC50
27ER 8RD2M	5203300	8	5/8	27.43	4.50	2.90	●	●	●	●	●
22ER 10RD2M	5103500	10	1/2	22.10	3.71	2.39	●	●	●	●	●
27NR 8RD2M	5223300	8	5/8	27.43	4.50	2.90	●	●	●	●	●
22NR 10RD2M	5123500	10	1/2	22.10	3.71	2.39	●	●	●	●	●

API VO.055

American MT, AMT, AMMT*

16 & 22NR/ER - 3/8" & 1/2" I.C.

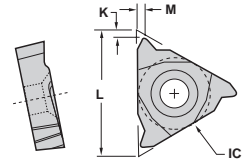

EXT RH SHOWN
INT OPPOSITE



Description	EDP Code	TPI	TPF	IC	L	M	K	Connection	TIN Coated		AITTN Coated		
									GP22	GP50	AC22	AC3	AC50
16ER 6P VO.055 MT	5004300	6	1-1/2	3/8	16.51	1.50	1.30	NC10-NC16, VO.055, 1, 1-1/2 REG	●	●	●	●	●
22ER 6P VO.055 MT	5104300	6	1-1/2	1/2	22.10	1.83	1.52	NC10-NC16, VO.055, 1, 1-1/2 REG	●	●	●	●	●
16NR 6P VO.055 MT	5024300	6	1-1/2	3/8	16.51	1.50	1.30	NC10-NC16, VO.055, 1, 1-1/2 REG	●	●	●	●	●
22NR 6P VO.055 MT	5124300	6	1-1/2	1/2	22.10	1.83	1.52	NC10-NC16, VO.055, 1, 1-1/2 REG	●	●	●	●	●

* MT is Macaroni Tubing, AMT is American Macaroni Tubing and AMMT is American Mining Macaroni Tubing.

API VAM

22NR/ER - 1/2" I.C.

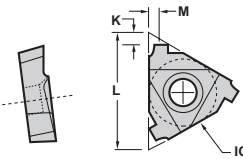

EXT RH SHOWN
INT OPPOSITE

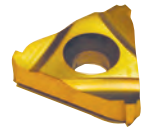

Description	EDP Code	TPI	IC	L	M	K	TIN Coated		AITTN Coated		
							GP22	GP50	AC22	AC3	AC50
22ER 8VAM	5102500	8	1/2	22.10	1.50	1.50	●	●	●	●	●
22ER 6VAM	5102400	6	1/2	22.10	2.01	2.01	●	●	●	●	●
22ER 5VAM	5102300	5	1/2	22.10	2.01	2.01	●	●	●	●	●
22NR 8VAM	5122500	8	1/2	22.10	1.50	1.50	●	●	●	●	●
22NR 6VAM	5122400	6	1/2	22.10	2.01	2.01	●	●	●	●	●
22NR 5VAM	5122300	5	1/2	22.10	2.01	2.01	●	●	●	●	●

API X-LINE

22NR/ER - 1/2" I.C.

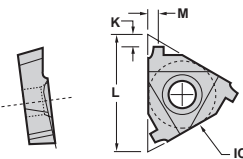

EXT RH SHOWN

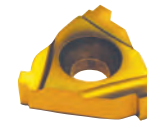

Description	EDP Code	TPI	TPF	IC	L	M	K	Conn. No.	TIN Coated		AITTN Coated		
									GP22	GP50	AC22	AC3	AC50
22ER 6XL75	5102000	6	3/4	1/2	22.10	1.91	1.98	5 - 7-5/8	●	●	●	●	●
22ER 6XL15	5101900	6	1-1/2	1/2	22.10	1.91	2.18	8-5/8 - 10-3/4	●	●	●	●	●
22ER 5XL12	5101800	5	1-1/4	1/2	22.10	2.21	2.11	8-5/8 - 10-3/4	●	●	●	●	●
22NR 6XL75	5122000	6	3/4	1/2	22.10	1.91	1.98	5 - 7-5/8	●	●	●	●	●
22NR 6XL15	5121900	6	1-1/2	1/2	22.10	1.91	2.18	8-5/8 - 10-3/4	●	●	●	●	●
22NR 5XL12	5121800	5	1-1/4	1/2	22.10	2.21	2.11	8-5/8 - 10-3/4	●	●	●	●	●

BSPT

16NR/ER - 3/8" I.C.

55° w/patented chipbreaker

Exclusive patented chipbreaker!

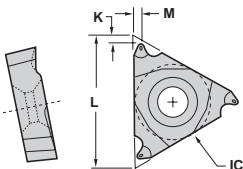

EXT RH SHOWN



Description	EDP Code	TPI	IC	L	M	K	TIN Coated		AITTN Coated		
							GP22	GP50	AC22	AC3	AC50
16ER 28BSPT-CB	5004428HC	28	3/8	16.00	0.79	0.71	●	●	●	●	●
16ER 19BSPT-CB	5004419HC	19	3/8	16.00	0.79	0.71	●	●	●	●	●
16ER 14BSPT-CB	5004414HC	14	3/8	16.00	1.50	1.50	●	●	●	●	●
16ER 11BSPT-CB	5004411HC	11	3/8	16.00	1.50	1.50	●	●	●	●	●
16NR 28BSPT-CB	5024428HC	28	3/8	16.00	0.79	0.79	●	●	●	●	●
16NR 19BSPT-CB	5024419HC	19	3/8	16.00	0.79	0.79	●	●	●	●	●
16NR 14BSPT-CB	5024428HC	14	3/8	16.00	0.79	0.79	●	●	●	●	●
16NR 11BSPT-CB	5024411HC	11	3/8	16.00	0.79	0.79	●	●	●	●	●

In an effort to improve our stock standard grade offering, there are periodic changes. Please see current price list for up to date grade offering.

- High performance choice in optimal conditions.
- ▲ Recommended grade under general conditions.

Material	GP22	GP50	AC22	AC3	AC50
Cast Iron	●	●	●	●	●
Non-Ferrous	●	●	●	●	●
Stainless/High Temp	●	●	●	●	●
Steel	●	●	●	●	●



GROOVING 16NR/ER - 3/8" I.C.

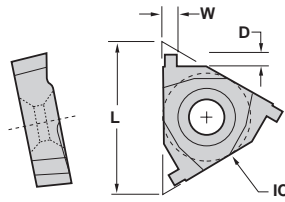

EXT RH SHOWN

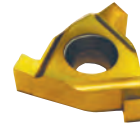

Description	EDP Code	IC	W	D	L	TIN Coated		A11N Coated		
						GP22	GP50	AC22	AC3	AC50
16ER NG W.031	5007431	3/8	0.79 (.031)	1.27	16.00	●	●			●
16EL NG W.031	5047431	3/8	0.79 (.031)	1.27	16.00	●	●			
16ER NG W.047	5007447	3/8	1.19 (.047)	1.78	16.00	●	●			●
16EL NG W.047	5047447	3/8	1.19 (.047)	1.78	16.00	●	●			
16ER NG W.062	5007462	3/8	1.57 (.062)	2.03	16.00	●	●			●
16EL NG W.062	5047462	3/8	1.57 (.062)	2.03	16.00	●	●			
16ER NG W.093	5007493	3/8	2.36 (.093)	1.78	16.00	●	●			●
16EL NG W.093	5047493	3/8	2.36 (.093)	1.78	16.00	●	●			
16ER NG W.125	5007625	3/8	3.18 (.125)	1.14	16.00	●	●			●
16EL NG W.125	5047625	3/8	3.18 (.125)	1.14	16.00	●	●			
16NR NG W.031	5027431	3/8	0.79 (.031)	1.27	16.00	●	●			●
16NL NG W.031	5067431	3/8	0.79 (.031)	1.27	16.00	●	●			
16NR NG W.047	5027447	3/8	1.19 (.047)	1.78	16.00	●	●			●
16NL NG W.047	5067447	3/8	1.19 (.047)	1.78	16.00	●	●			
16NR NG W.062	5027462	3/8	1.57 (.062)	2.03	16.00	●	●			●
16NL NG W.062	5067462	3/8	1.57 (.062)	2.03	16.00	●	●			
16NR NG W.093	5027493	3/8	2.36 (.093)	1.78	16.00	●	●			●
16NL NG W.093	5067493	3/8	2.36 (.093)	1.78	16.00	●	●			
16NR NG W.125	5027625	3/8	3.18 (.125)	1.14	16.00	●	●			●
16NL NG W.125	5067625	3/8	3.18 (.125)	1.14	16.00	●	●			

LAYDOWN

ISO 16NR/ER - 3/8" I.C. w/patented chipbreaker

Exclusive patented chipbreaker!

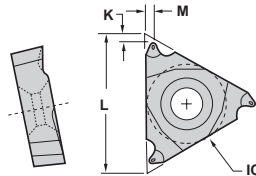

EXT RH SHOWN



Description	EDP Code	Pitch	IC	L	M	K	TIN Coated		A11N Coated		
							GP22	GP50	AC22	AC3	AC50
16NR 0.75ISO-CB	50242075HC	0,75	3/8	16.00	0.51	1.02	●	●	●	●	●
16NR 1.0ISO-CB	5024201HC	1,00	3/8	16.00	0.76	0.76	●	●	●	●	●
16NR 1.25ISO-CB	502420125HC	1,25	3/8	16.00	0.76	0.76	●	●	●	●	●
16NR 1.5ISO-CB	50242015HC	1,50	3/8	16.00	0.76	0.76	●	●	●	●	●
16NR 1.75ISO-CB	502420175HC	1,75	3/8	16.00	1.52	1.02	●	●	●	●	●
16NR 2.0ISO-CB	5024202HC	2,00	3/8	16.00	1.52	1.02	●	●	●	●	●
16NR 2.5ISO-CB	50242025HC	2,50	3/8	16.00	1.52	1.02	●	●	●	●	●
16NR 3.0ISO-CB	5024203HC	3,00	3/8	16.00	1.52	1.02	●	●	●	●	●
16ER 0.75ISO-CB	50042075HC	0,75	3/8	16.00	0.51	1.02	●	●	●	●	●
16ER 1.0ISO-CB	5004201HC	1,00	3/8	16.00	0.76	0.76	●	●	●	●	●
16ER 1.25ISO-CB	500420125HC	1,25	3/8	16.00	0.76	0.76	●	●	●	●	●
16ER 1.5ISO-CB	50042015HC	1,50	3/8	16.00	0.76	0.76	●	●	●	●	●
16ER 1.75ISO-CB	500420175HC	1,75	3/8	16.00	1.52	1.02	●	●	●	●	●
16ER 2.0ISO-CB	5004202HC	2,00	3/8	16.00	1.52	1.02	●	●	●	●	●
16ER 2.5ISO-CB	50042025HC	2,50	3/8	16.00	1.52	1.02	●	●	●	●	●
16ER 3.0ISO-CB	5004203HC	3,00	3/8	16.00	1.52	1.02	●	●	●	●	●

In an effort to improve our stock standard grade offering, there are periodic changes. Please see current price list for up to date grade offering.

- High performance choice in optimal conditions.
- ▲ Recommended grade under general conditions.

Cast Iron					●
Non-Ferrous					●
Stainless/High Temp					●
Steel	▲				●



LAYDOWN

ISO

11, 16, 22 & 27NR/ER - 1/4", 3/8", 1/2" & 5/8" I.C.

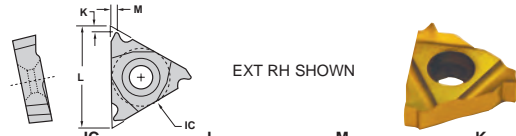

Description	EDP Code	Pitch	IC	L	M	K	TiN Coated		AlTiN Coated	
							GP22	GP50	AC22	AC3
11NR 0.5ISO	4924205	0,50	1/4	10.92	0.51	0.38	●	●	●	●
11NR 0.75ISO	49242075	0,75	1/4	10.92	0.51	0.51	●	●	●	●
11NR 1.0ISO	4924210	1,0	1/4	10.92	0.76	0.76	●	●	●	●
16NR 1.0ISO	5024201	1,0	3/8	16.00	0.76	0.51	●	●	●	●
16NR 1.5ISO	50242015	1,5	3/8	16.00	1.02	0.76	●	●	●	●
16NR 2.0ISO	5024202	2,0	3/8	16.00	1.27	1.02	●	●	●	●
22NR 3.5ISO	51242035	3,5	1/2	22.10	2.29	1.52	●	●	●	●
22NR 4.0ISO	5124204	4,0	1/2	22.10	2.29	1.52	●	●	●	●
22NR 5.0ISO	5124205	5,0	1/2	22.10	2.29	1.52	●	●	●	●
27NR 5.5ISO	52242055	5,5	5/8	26.92	2.29	1.52	●	●	●	●
27NR 6.0ISO	5224206	6,0	5/8	26.92	2.54	1.78	●	●	●	●
11ER 0.5ISO	4904205	0,50	1/4	10.92	0.51	0.51	●	●	●	●
11ER 0.75ISO	49042075	0,75	1/4	10.92	0.51	0.51	●	●	●	●
11ER 1.0ISO	4904210	1,0	1/4	10.92	0.76	0.51	●	●	●	●
16ER 1.0ISO	5004201	1,0	3/8	16.00	0.76	0.76	●	●	●	●
16ER 1.5ISO	50042015	1,5	3/8	16.00	1.02	0.76	●	●	●	●
16ER 2.0ISO	5004202	2,0	3/8	16.00	1.27	1.02	●	●	●	●
22ER 3.5ISO	50042035	3,5	1/2	22.10	2.29	1.52	●	●	●	●
22ER 4.0ISO	5104204	4,0	1/2	22.10	2.29	1.78	●	●	●	●
22ER 5.0ISO	5104205	5,0	1/2	22.10	2.54	1.78	●	●	●	●
27ER 5.5ISO	52042055	5,5	5/8	26.92	2.79	1.78	●	●	●	●
27ER 6.0ISO	5204206	6,0	5/8	26.92	2.79	2.03	●	●	●	●

NPT

16NR/ER - 3/8" I.C.

w/patented chipbreaker

Exclusive patented chipbreaker!

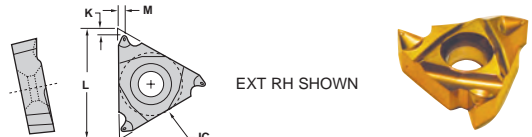

Description	EDP Code	TPI	IC	L	M	K	TiN Coated		AlTiN Coated	
							GP22	GP50	AC22	AC3
16ER 27NPT-CB	5003627HC	27	3/8	16.00	0.76	0.51	●	●	●	●
16ER 18NPT-CB	5003618HC	18	3/8	16.00	0.76	0.51	●	●	●	●
16ER 14NPT-CB	5003614HC	14	3/8	16.00	1.52	1.02	●	●	●	●
16ER 11.5NPT-CB	5003611HC	11.5	3/8	16.00	1.52	1.02	●	●	●	●
16ER 8NPT-CB	5003608HC	8	3/8	16.00	1.52	1.02	●	●	●	●
16NR 27NPT-CB	5023627HC	27	3/8	16.00	0.76	0.51	●	●	●	●
16NR 18NPT-CB	5023618HC	18	3/8	16.00	0.76	0.51	●	●	●	●
16NR 14NPT-CB	5023614HC	14	3/8	16.00	1.52	1.02	●	●	●	●
16NR 11.5NPT-CB	5023611HC	11.5	3/8	16.00	1.52	1.02	●	●	●	●
16NR 8NPT-CB	5023608HC	8	3/8	16.00	1.52	1.02	●	●	●	●

NPT

11 & 16NR/ER - 1/4" & 3/8" I.C.

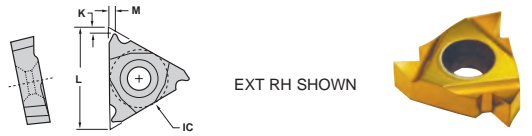

Description	EDP Code	TPI	IC	L	M	K	TiN Coated		AlTiN Coated	
							GP22	GP50	AC22	AC3
16ER 27NPT	5003627	27	3/8	16.00	0.76	0.76	●	●	●	●
16EL 27NPT	5043627	27	3/8	16.00	0.76	0.76	●	●	●	●
16ER 18NPT	5003618	18	3/8	16.00	1.02	0.76	●	●	●	●
16EL 18NPT	5043618	18	3/8	16.00	1.02	0.76	●	●	●	●
16ER 14NPT	5003614	14	3/8	16.00	1.27	1.02	●	●	●	●
16EL 14NPT	5043614	14	3/8	16.00	1.27	1.02	●	●	●	●
16ER 11.5NPT	5003611	11.5	3/8	16.00	1.52	1.02	●	●	●	●
16EL 11.5NPT	5043611	11.5	3/8	16.00	1.52	1.02	●	●	●	●
16ER 8NPT	5003608	8	3/8	16.00	1.78	1.27	●	●	●	●
16EL 8NPT	5043608	8	3/8	16.00	1.78	1.27	●	●	●	●
11NR 18NPT	4923618	18	1/4	10.92	1.02	0.76	●	●	●	●
11NR 27NPT	4923627	27	1/4	10.92	0.76	0.76	●	●	●	●
16NR 27NPT	5023627	27	3/8	16.00	0.76	0.76	●	●	●	●
16NL 27NPT	5063627	27	3/8	16.00	0.76	0.76	●	●	●	●
16NR 18NPT	5023618	18	3/8	16.00	1.02	0.76	●	●	●	●
16NL 18NPT	5063618	18	3/8	16.00	1.02	0.76	●	●	●	●
16NR 14NPT	5023614	14	3/8	16.00	1.27	1.02	●	●	●	●
16NL 14NPT	5063614	14	3/8	16.00	1.27	1.02	●	●	●	●
16NR 11.5NPT	5023611	11.5	3/8	16.00	1.52	1.02	●	●	●	●
16NL 11.5NPT	5063611	11.5	3/8	16.00	1.52	1.02	●	●	●	●
16NR 8NPT	5023608	8	3/8	16.00	1.52	1.27	●	●	●	●
16NL 8NPT	5063608	8	3/8	16.00	1.52	1.27	●	●	●	●

In an effort to improve our stock standard grade offering, there are periodic changes. Please see current price list for up to date grade offering.

- High performance choice in optimal conditions.
- ▲ Recommended grade under general conditions.

Material	GP22	GP50	AC22	AC3	AC50
Cast Iron	▲	▲	▲	▲	▲
Non-Ferrous	▲	▲	▲	▲	▲
Stainless/High Temp	▲	▲	▲	▲	▲
Steel	▲	▲	▲	▲	▲

LAYDOWN



NPT

22 & 27NR/ER - 1/2" & 5/8" I.C.

Multi-tooth

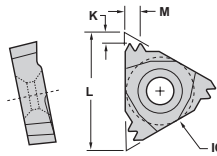

EXT RH SHOWN

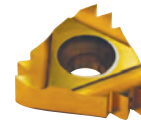

Description	EDP Code	TPI	IC	L	M	K	TIN Coated		AlTiN Coated		
							GP22	GP50	AC22	AC3	AC50
22ER 11.5NPT2M	5103811	11.5	1/2	22.10	3.30	2.29	●	●	●	●	●
27ER 11.5NPT3M	5203811	11.5	5/8	26.92	5.59	3.56	●	●	●	●	●
27ER 8NPT2M	5203808	8	5/8	26.92	4.83	2.79	●	●	●	●	●
22NR 11.5NPT2M	5123811	11.5	1/2	22.10	3.30	2.29	●	●	●	●	●
27NR 11.5NPT3M	5223811	11.5	5/8	26.92	5.59	3.56	●	●	●	●	●
27NR 8NPT2M	5223808	8	5/8	26.92	4.83	2.79	●	●	●	●	●

TRAPEZOIDAL

16NR/ER - 3/8" I.C.

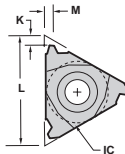

EXT RH SHOWN

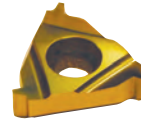

Description	EDP Code	Pitch	IC	L	M	K	TIN Coated		AlTiN Coated		
							GP22	GP50	AC22	AC3	AC50
16ER 1.5TR	5007015	1.5	3/8	16.00	1.02	1.02	●	●	●	●	●
16ER 2.0TR	5007020	2.0	3/8	16.00	1.27	1.02	●	●	●	●	●
16ER 3.0TR	5007030	3.0	3/8	16.00	1.52	1.27	●	●	●	●	●
16NR 1.5TR	5027015	1.5	3/8	16.00	1.02	1.02	●	●	●	●	●
16NR 2.0TR	5027020	2.0	3/8	16.00	1.27	1.02	●	●	●	●	●
16NR 3.0TR	5027030	3.0	3/8	16.00	1.52	1.27	●	●	●	●	●

NPTF DRY SEAL

16NR/ER - 3/8" I.C.

w/ patented chipbreaker

Exclusive patented chipbreaker!

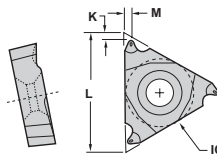

EXT RH SHOWN



Description	EDP Code	TPI	IC	L	M	K	TIN Coated		AlTiN Coated		
							GP22	GP50	AC22	AC3	AC50
16ER 27NPTF-CB	5004027HC	27	3/8	16.00	0.76	0.76	●	●	●	●	●
16ER 18NPTF-CB	5004018HC	18	3/8	16.00	1.02	0.76	●	●	●	●	●
16ER 14NPTF-CB	5004014HC	14	3/8	16.00	1.27	1.02	●	●	●	●	●
16ER 11.5NPTF-CB	5004011HC	11.5	3/8	16.00	1.52	1.02	●	●	●	●	●
16ER 8NPTF-CB	5004008HC	8	3/8	16.00	1.78	1.27	●	●	●	●	●
16NR 27NPTF-CB	5024027HC	27	3/8	16.00	0.76	0.76	●	●	●	●	●
16NR 18NPTF-CB	5024018HC	18	3/8	16.00	0.76	0.51	●	●	●	●	●
16NR 14NPTF-CB	5024014HC	14	3/8	16.00	1.52	1.02	●	●	●	●	●
16NR 11.5NPTF-CB	5024011HC	11.5	3/8	16.00	1.52	1.02	●	●	●	●	●
16NR 8NPTF-CB	5024008HC	8	3/8	16.00	1.52	1.02	●	●	●	●	●

NPTF DRY SEAL

11 & 16NR/NL/ER/EL - 1/4" & 3/8" I.C.

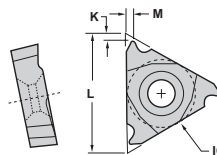

EXT RH SHOWN

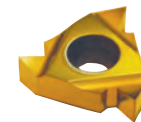

Description	EDP Code	TPI	IC	L	M	K	TIN Coated		AlTiN Coated		
							GP22	GP50	AC22	AC3	AC50
16ER 27NPTF	5004027	27	3/8	16.00	0.76	0.76	●	●	●	●	●
16EL 27NPTF	5043827	27	3/8	16.00	0.76	0.76	●	●	●	●	●
16ER 18NPTF	5004018	18	3/8	16.00	1.02	0.76	●	●	●	●	●
16EL 18NPTF	5043818	18	3/8	16.00	1.02	0.76	●	●	●	●	●
16ER 14NPTF	5004014	14	3/8	16.00	1.27	1.02	●	●	●	●	●
16EL 14NPTF	5043814	14	3/8	16.00	1.27	1.02	●	●	●	●	●
16ER 11.5NPTF	5004011	11.5	3/8	16.00	1.52	1.02	●	●	●	●	●
16EL 11.5NPTF	5043811	11.5	3/8	16.00	1.52	1.02	●	●	●	●	●
16ER 8NPTF	5004008	8	3/8	16.00	1.78	1.27	●	●	●	●	●
16EL 8NPTF	5043808	8	3/8	16.00	1.78	1.27	●	●	●	●	●
11NR 27NPTF	4923827	27	1/4	10.92	0.76	0.76	●	●	●	●	●
11NR 18NPTF	4924018	18	1/4	10.92	1.02	0.76	●	●	●	●	●
16NR 27NPTF	5024027	27	3/8	16.00	0.76	0.76	●	●	●	●	●
16NL 27NPTF	5063827	27	3/8	16.00	0.76	0.76	●	●	●	●	●
16NR 18NPTF	5024018	18	3/8	16.00	1.02	0.76	●	●	●	●	●
16NL 18NPTF	5063818	18	3/8	16.00	1.02	0.76	●	●	●	●	●
16NR 14NPTF	5024014	14	3/8	16.00	1.27	1.02	●	●	●	●	●
16NL 14NPTF	5063814	14	3/8	16.00	1.27	1.02	●	●	●	●	●
16NR 11.5NPTF	5024011	11.5	3/8	16.00	1.52	1.02	●	●	●	●	●
16NL 11.5NPTF	5063811	11.5	3/8	16.00	1.52	1.02	●	●	●	●	●
16NR 8NPTF	5024008	8	3/8	16.00	1.78	1.27	●	●	●	●	●
16NL 8NPTF	5063808	8	3/8	16.00	1.78	1.27	●	●	●	●	●

In an effort to improve our stock standard grade offering, there are periodic changes. Please see current price list for up to date grade offering.

- High performance choice in optimal conditions.
- ▲ Recommended grade under general conditions.

Material	GP22	GP50	AC22	AC3	AC50
Cast Iron	▲	●	●	●	●
Non-Ferrous	▲	●	●	●	●
Stainless/High Temp	▲	●	●	●	●
Steel	▲	●	●	●	●



LAYDOWN

UN

16ER - 3/8" I.C.

w/ patented chipbreaker

Exclusive patented chipbreaker!

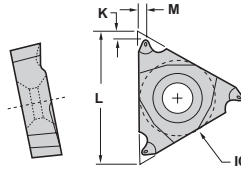

EXT RH SHOWN

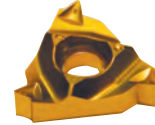

Description	EDP Code	TPI	IC	L	M	K	TIN Coated		ATTIN Coated		
							GP22	GP50	AC22	AC3	AC50
16ER 32UN-CB	5006632HC	32	3/8	16.00	0.25	1.27	●	●	●	●	●
16ER 28UN-CB	5006628HC	28	3/8	16.00	0.76	0.76	●	●	●	●	●
16ER 24UN-CB	5006624HC	24	3/8	16.00	0.76	0.76	●	●	●	●	●
16ER 20UN-CB	5006620HC	20	3/8	16.00	0.76	0.76	●	●	●	●	●
16ER 18UN-CB	5006618HC	18	3/8	16.00	0.76	0.76	●	●	●	●	●
16ER 16UN-CB	5006616HC	16	3/8	16.00	0.76	0.76	●	●	●	●	●
16ER 14UN-CB	5006614HC	14	3/8	16.00	1.52	1.27	●	●	●	●	●
16ER 13UN-CB	5006613HC	13	3/8	16.00	1.52	1.27	●	●	●	●	●
16ER 12UN-CB	5006612HC	12	3/8	16.00	1.52	1.27	●	●	●	●	●
16ER 10UN-CB	5006610HC	10	3/8	16.00	1.52	1.27	●	●	●	●	●
16ER 8UN-CB	5006608HC	8	3/8	16.00	1.52	1.27	●	●	●	●	●

UN

16 & 22ER/EL - 3/8" & 1/2" I.C.

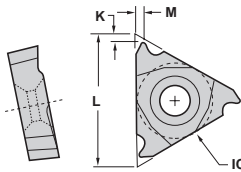

EXT RH SHOWN

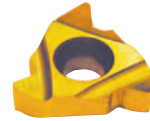

Description	EDP Code	TPI	IC	L	M	K	TIN Coated		ATTIN Coated		
							GP22	GP50	AC22	AC3	AC50
16ER 32UN	5006632	32	3/8	16.00	0.51	0.51	●	●	●	●	●
16EL 32UN	5046632	32	3/8	16.00	0.51	0.51	●	●	●	●	●
16ER 28UN	5006628	28	3/8	16.00	0.76	0.51	●	●	●	●	●
16EL 28UN	5046628	28	3/8	16.00	0.76	0.51	●	●	●	●	●
16ER 24UN	5006624	24	3/8	16.00	0.76	0.76	●	●	●	●	●
16EL 24UN	5046624	24	3/8	16.00	0.76	0.76	●	●	●	●	●
16ER 20UN	5006620	20	3/8	16.00	1.02	0.76	●	●	●	●	●
16EL 20UN	5046620	20	3/8	16.00	1.02	0.76	●	●	●	●	●
16ER 18UN	5006618	18	3/8	16.00	1.02	0.76	●	●	●	●	●
16EL 18UN	5046618	18	3/8	16.00	1.02	0.76	●	●	●	●	●
16ER 16UN	5006616	16	3/8	16.00	1.02	1.02	●	●	●	●	●
16EL 16UN	5046616	16	3/8	16.00	1.02	1.02	●	●	●	●	●
16ER 14UN	5006614	14	3/8	16.00	1.27	1.02	●	●	●	●	●
16EL 14UN	5046614	14	3/8	16.00	1.27	1.02	●	●	●	●	●
16ER 13UN	5006613	13	3/8	16.00	1.27	1.02	●	●	●	●	●
16EL 13UN	5046613	13	3/8	16.00	1.27	1.02	●	●	●	●	●
16ER 12UN	5006612	12	3/8	16.00	1.52	1.02	●	●	●	●	●
16EL 12UN	5046612	12	3/8	16.00	1.52	1.02	●	●	●	●	●
16ER 11UN	5006611	11	3/8	16.00	1.52	1.02	●	●	●	●	●
16EL 11UN	5046611	11	3/8	16.00	1.52	1.02	●	●	●	●	●
16ER 10UN	5006610	10	3/8	16.00	1.52	1.02	●	●	●	●	●
16EL 10UN	5046610	10	3/8	16.00	1.52	1.02	●	●	●	●	●
16ER 9UN	5006609	9	3/8	16.00	1.78	1.27	●	●	●	●	●
16EL 9UN	5046609	9	3/8	16.00	1.78	1.27	●	●	●	●	●
16ER 8UN	5006608	8	3/8	16.00	1.52	1.27	●	●	●	●	●
16EL 8UN	5046608	8	3/8	16.00	1.52	1.27	●	●	●	●	●
22ER 7UN	5106607	7	1/2	22.10	2.29	1.52	●	●	●	●	●
22EL 7UN	5146607	7	1/2	22.10	2.29	1.52	●	●	●	●	●
22ER 6UN	5106606	6	1/2	22.10	2.29	1.52	●	●	●	●	●
22EL 6UN	5146606	6	1/2	22.10	2.29	1.52	●	●	●	●	●
22ER 5UN	5106605	5	1/2	22.10	2.54	1.78	●	●	●	●	●
22EL 5UN	5146605	5	1/2	22.10	2.54	1.78	●	●	●	●	●
27ER 4.5UN	52066045	4.5	5/8	26.92	2.79	1.78	●	●	●	●	●
27EL 4.5UN	52466045	4.5	5/8	26.92	2.79	1.78	●	●	●	●	●
27ER 4UN	5206604	4	5/8	26.92	3.05	2.03	●	●	●	●	●
27EL 4UN	5246604	4	5/8	26.92	3.05	2.03	●	●	●	●	●

In an effort to improve our stock standard grade offering, there are periodic changes. Please see current price list for up to date grade offering.

- High performance choice in optimal conditions.
- ▲ Recommended grade under general conditions.

Cast Iron	▲			●
Non-Ferrous				
Stainless/High Temp	▲			●
Steel		▲		●





UN

16NR - 3/8" I.C.

w/ patented chipbreaker

Exclusive patented chipbreaker!

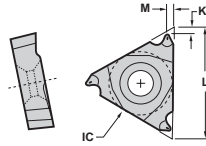

INT RH SHOWN

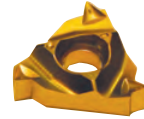

Description	EDP Code	TPI	IC	L	M	K	TiN Coated		AlTiN Coated		
							GP22	GP50	AC22	AC3	AC50
16NR 32UN-CB	5026632HC	32	3/8	16.00	0.51	1.02	●	●	●	●	●
16NR 28UN-CB	5026628HC	28	3/8	16.00	0.76	0.51	●	●	●	●	●
16NR 24UN-CB	5026624HC	24	3/8	16.00	0.76	0.76	●	●	●	●	●
16NR 20UN-CB	5026620HC	20	3/8	16.00	0.76	0.51	●	●	●	●	●
16NR 18UN-CB	5026618HC	18	3/8	16.00	0.76	0.51	●	●	●	●	●
16NR 16UN-CB	5026616HC	16	3/8	16.00	0.76	0.76	●	●	●	●	●
16NR 14UN-CB	5026614HC	14	3/8	16.00	1.27	1.02	●	●	●	●	●
16NR 13UN-CB	5026613HC	13	3/8	16.00	1.27	1.02	●	●	●	●	●
16NR 12UN-CB	5026612HC	12	3/8	16.00	1.27	1.02	●	●	●	●	●
16NR 10UN-CB	5026610HC	10	3/8	16.00	1.27	1.02	●	●	●	●	●
16NR 8UN-CB	5026608HC	8	3/8	16.00	1.27	1.02	●	●	●	●	●

UN

11, 16, 22 & 27NR - 1/4", 3/8", 1/2" & 5/8" I.C.

LAYDOWN

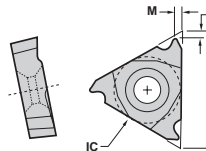

INT RH SHOWN



Description	EDP Code	TPI	IC	L	M	K	TiN Coated		AlTiN Coated		
							GP22	GP50	AC22	AC3	AC50
11NR 32UN	4926632	32	1/4	10.92	0.51	0.51	●	●	●	●	●
11NR 28UN	4926628	28	1/4	10.92	0.76	0.51	●	●	●	●	●
11NR 24UN	4926624	24	1/4	10.92	0.76	0.76	●	●	●	●	●
11NR 20UN	4926620	20	1/4	10.92	1.02	0.76	●	●	●	●	●
11NR 18UN	4926618	18	1/4	10.92	1.02	0.76	●	●	●	●	●
16NR 32UN	5026632	32	3/8	16.00	0.51	0.51	●	●	●	●	●
16NL 32UN	5066632	32	3/8	16.00	0.51	0.51	●	●	●	●	●
16NR 28UN	5026628	28	3/8	16.00	0.76	0.51	●	●	●	●	●
16NL 28UN	5066628	28	3/8	16.00	0.76	0.51	●	●	●	●	●
16NR 24UN	5026624	24	3/8	16.00	0.76	0.76	●	●	●	●	●
16NL 24UN	5066624	24	3/8	16.00	0.76	0.76	●	●	●	●	●
16NR 20UN	5026620	20	3/8	16.00	1.02	0.76	●	●	●	●	●
16NL 20UN	5066620	20	3/8	16.00	1.02	0.76	●	●	●	●	●
16NR 18UN	5026618	18	3/8	16.00	1.02	0.76	●	●	●	●	●
16NL 18UN	5066618	18	3/8	16.00	1.02	0.76	●	●	●	●	●
16NR 16UN	5026616	16	3/8	16.00	1.02	1.02	●	●	●	●	●
16NL 16UN	5066616	16	3/8	16.00	1.02	1.02	●	●	●	●	●
16NR 14UN	5026614	14	3/8	16.00	1.27	1.02	●	●	●	●	●
16NL 14UN	5066614	14	3/8	16.00	1.27	1.02	●	●	●	●	●
16NR 13UN	5026613	13	3/8	16.00	1.27	1.02	●	●	●	●	●
16NL 13UN	5066613	13	3/8	16.00	1.27	1.02	●	●	●	●	●
16NR 12UN	5026612	12	3/8	16.00	1.52	1.02	●	●	●	●	●
16NL 12UN	5066612	12	3/8	16.00	1.52	1.02	●	●	●	●	●
16NR 11UN	5026611	11	3/8	16.00	1.52	1.02	●	●	●	●	●
16NL 11UN	5066611	11	3/8	16.00	1.52	1.02	●	●	●	●	●
16NR 10UN	5026610	10	3/8	16.00	1.52	1.02	●	●	●	●	●
16NL 10UN	5066610	10	3/8	16.00	1.52	1.02	●	●	●	●	●
16NR 9UN	5026609	9	3/8	16.00	1.78	1.27	●	●	●	●	●
16NL 9UN	5066609	9	3/8	16.00	1.78	1.27	●	●	●	●	●
16NR 8UN	5026608	8	3/8	16.00	1.52	1.02	●	●	●	●	●
16NL 8UN	5066608	8	3/8	16.00	1.52	1.02	●	●	●	●	●
22NR 7UN	5126607	7	1/2	22.10	2.29	1.52	●	●	●	●	●
22NL 7UN	5166607	7	1/2	22.10	2.29	1.52	●	●	●	●	●
22NR 6UN	5126606	6	1/2	22.10	2.29	1.52	●	●	●	●	●
22NL 6UN	5166606	6	1/2	22.10	2.29	1.52	●	●	●	●	●
22NR 5UN	5126605	5	1/2	22.10	2.29	1.52	●	●	●	●	●
22NL 5UN	5166605	5	1/2	22.10	2.29	1.52	●	●	●	●	●
27NR 4.5UN	52266045	4.5	5/8	26.92	2.29	1.78	●	●	●	●	●
27NL 4.5UN	52666045	4.5	5/8	26.92	2.29	1.78	●	●	●	●	●
27NR 4UN	5226604	4	5/8	26.92	2.79	1.78	●	●	●	●	●
27NL 4UN	5266604	4	5/8	26.92	2.79	1.78	●	●	●	●	●

In an effort to improve our stock standard grade offering, there are periodic changes. Please see current price list for up to date grade offering.

- High performance choice in optimal conditions.
- ▲ Recommended grade under general conditions.

Cast Iron	▲			●
Non-Ferrous	▲			●
Stainless/High Temp	▲			●
Steel		▲		●



LAYDOWN

UNJ

16NR - 3/8" I.C.

w/ patented chipbreaker

Exclusive patented chipbreaker!

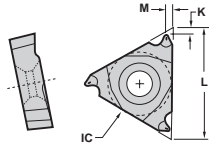

INT RH SHOWN

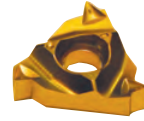

Description	EDP Code	TPI	IC	L	M	K	TIN Coated		AlTiN Coated		
							GP22	GP50	AC22	AC3	AC50
16NR 32UNJ-CB	5026832HC	32	3/8	16.00	0.51	1.02	●	●	●	●	●
16NR 28UNJ-CB	5026828HC	28	3/8	16.00	0.76	0.51	●	●	●	●	●
16NR 24UNJ-CB	5026824HC	24	3/8	16.00	0.76	0.51	●	●	●	●	●
16NR 20UNJ-CB	5026820HC	20	3/8	16.00	0.76	0.51	●	●	●	●	●
16NR 18UNJ-CB	5026818HC	18	3/8	16.00	0.76	0.51	●	●	●	●	●
16NR 16UNJ-CB	5026816HC	16	3/8	16.00	0.76	0.51	●	●	●	●	●
16NR 14UNJ-CB	5026814HC	14	3/8	16.00	1.52	1.02	●	●	●	●	●
16NR 12UNJ-CB	5026812HC	12	3/8	16.00	1.52	1.02	●	●	●	●	●
16NR 10UNJ-CB	5026810HC	10	3/8	16.00	1.52	1.02	●	●	●	●	●

UNJ

16ER - 3/8" I.C.

w/ patented chipbreaker

Exclusive patented chipbreaker!

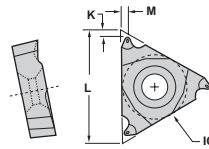

EXT RH SHOWN

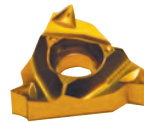

Description	EDP Code	TPI	IC	L	M	K	TIN Coated		AlTiN Coated		
							GP22	GP50	AC22	AC3	AC50
16ER 32UNJ-CB	5006832HC	32	3/8	16.00	0.51	1.27	●	●	●	●	●
16ER 28UNJ-CB	5006828HC	28	3/8	16.00	0.76	0.76	●	●	●	●	●
16ER 24UNJ-CB	5006824HC	24	3/8	16.00	0.76	0.76	●	●	●	●	●
16ER 20UNJ-CB	5006820HC	20	3/8	16.00	0.76	0.76	●	●	●	●	●
16ER 18UNJ-CB	5006818HC	18	3/8	16.00	0.76	0.76	●	●	●	●	●
16ER 16UNJ-CB	5006816HC	16	3/8	16.00	0.76	0.76	●	●	●	●	●
16ER 14UNJ-CB	5006814HC	14	3/8	16.00	1.52	1.27	●	●	●	●	●
16ER 12UNJ-CB	5006812HC	12	3/8	16.00	1.52	1.27	●	●	●	●	●
16ER 10UNJ-CB	5006810HC	10	3/8	16.00	1.52	1.27	●	●	●	●	●

UNJ

16ER - 3/8" I.C.

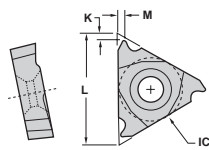

EXT RH SHOWN

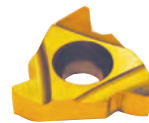

Description	EDP Code	TPI	IC	L	M	K	TIN Coated		AlTiN Coated		
							GP22	GP50	AC22	AC3	AC50
16ER 32UNJ	5006832	32	3/8	16.00	0.76	0.51	●	●	●	●	●
16ER 28UNJ	5006828	28	3/8	16.00	0.76	0.76	●	●	●	●	●
16ER 24UNJ	5006824	24	3/8	16.00	0.76	0.76	●	●	●	●	●
16ER 20UNJ	5006820	20	3/8	16.00	1.02	0.76	●	●	●	●	●
16ER 18UNJ	5006818	18	3/8	16.00	1.02	0.76	●	●	●	●	●
16ER 16UNJ	5006816	16	3/8	16.00	1.02	1.02	●	●	●	●	●
16ER 14UNJ	5006814	14	3/8	16.00	1.27	1.02	●	●	●	●	●
16ER 12UNJ	5006812	12	3/8	16.00	1.27	1.02	●	●	●	●	●
16ER 10UNJ	5006810	10	3/8	16.00	1.52	1.27	●	●	●	●	●
16ER 8UNJ	5006808	8	3/8	16.00	1.52	1.27	●	●	●	●	●

V THREADING - 60°

16ER/NR - 3/8" I.C.

w/ patented chipbreaker

Exclusive patented chipbreaker!

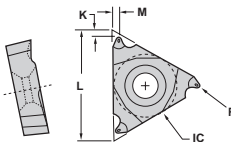

EXT RH SHOWN



Description	EDP Code	Pitch (mm)	IC	L	M	K	R	TIN Coated		AlTiN Coated		
								GP22	GP50	AC22	AC3	AC50
16ER A60-CB	5004600HC	0.53-1.59	3/8	16.00	0.76	0.51	0.08	●	●	●	●	●
16ER AG60-CB	5004800HC	0.53-3.18	3/8	16.00	1.52	1.02	0.08	●	●	●	●	●
16ER G60-CB	5005000HC	1.80-3.18	3/8	16.00	1.52	1.02	0.18	●	●	●	●	●
16NR A60-CB	5024600HC	0.53-1.59	3/8	16.00	0.76	0.76	0.05	●	●	●	●	●
16NR AG60-CB	5024800HC	0.53-3.18	3/8	16.00	1.52	1.02	0.05	●	●	●	●	●
16NR G60-CB	5025000HC	1.80-3.18	3/8	16.00	1.52	1.02	0.18	●	●	●	●	●

In an effort to improve our stock standard grade offering, there are periodic changes. Please see current price list for up to date grade offering.

- High performance choice in optimal conditions.
- ▲ Recommended grade under general conditions.

	Cast Iron	Non-Ferrous	Stainless/High Temp	Steel
GP22	▲	●	●	●
GP50	▲	●	●	●
AC22	▲	●	●	●
AC3	▲	●	●	●
AC50	▲	●	●	●



V THREADING - 55°

16ER/NR - 3/8" I.C.

w/ patented chipbreaker

Exclusive patented chipbreaker!

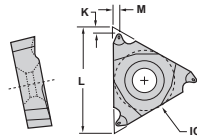

EXT RH SHOWN



Description	EDP Code	Pitch (mm)	IC	L	M	K	R	TIN Coated		AlTiN Coated		
								GP22	GP50	AC22	AC3	AC50
16ER A55-CB	5005400HC	0.50-1.5	3/8	16.00	0.76	0.51	0.05	●	●	●	●	●
16ER AG55-CB	5005600HC	0.50-3.0	3/8	16.00	1.52	1.02	0.08	●	●	●	●	●
16ER G55-CB	5005800HC	1.75-3.0	3/8	16.00	1.52	1.02	0.20	●	●	●	●	●
16NR A55-CB	5025400HC	0.50-1.5	3/8	16.00	0.76	0.51	0.05	●	●	●	●	●
16NR AG55-CB	5025600HC	0.50-3.0	3/8	16.00	1.52	1.02	0.08	●	●	●	●	●
16NR G55-CB	5025800HC	1.75-3.0	3/8	16.00	1.52	1.02	0.20	●	●	●	●	●

V THREADING - 55° & 60°

11, 16 & 22ER/NR - 1/4", 3/8" & 1/2" I.C.

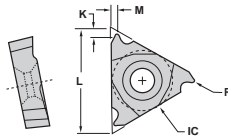

EXT RH SHOWN

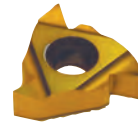

Description	EDP Code	Pitch (mm)	IC	L	M	K	R	TIN Coated		AlTiN Coated		
								GP22	GP50	AC22	AC3	AC50
16ER A60	5004600	0.50-1.5	3/8	16.00	1.02	0.76	0.08	●	●	●	●	●
16EL A60	5044600	0.50-1.5	3/8	16.00	1.02	0.76	0.08	●	●	●	●	●
16ER AG60	5004800	0.50-3.0	3/8	16.00	1.78	1.27	0.08	●	●	●	●	●
16EL AG60	5044800	0.50-3.0	3/8	16.00	1.78	1.27	0.08	●	●	●	●	●
16ER G60	5005000	1.75-3.0	3/8	16.00	1.78	1.27	0.18	●	●	●	●	●
16EL G60	5045000	1.75-3.0	3/8	16.00	1.78	1.27	0.18	●	●	●	●	●
22ER N60	5105200	3.50-5.0	1/2	22.10	2.54	1.78	0.41	●	●	●	●	●
22EL N60	5145200	3.50-5.0	1/2	22.10	2.54	1.78	0.41	●	●	●	●	●
11NR A55	4925400	0.50-1.5	1/4	10.92	1.02	0.76	0.08	●	●	●	●	●
11NR A60	4924600	0.50-1.5	1/4	10.92	1.02	0.76	0.08	●	●	●	●	●
16NR A60	5024600	0.50-1.5	3/8	16.00	1.02	0.76	0.08	●	●	●	●	●
16NL A60	5064600	0.50-1.5	3/8	16.00	1.02	0.76	0.08	●	●	●	●	●
16NR AG60	5024800	0.50-3.0	3/8	16.00	1.78	1.27	0.08	●	●	●	●	●
16NL AG60	5064800	0.50-3.0	3/8	16.00	1.78	1.27	0.08	●	●	●	●	●
16NR G60	5025000	1.75-3.0	3/8	16.00	1.78	1.27	0.18	●	●	●	●	●
16NL G60	5065000	1.75-3.0	3/8	16.00	1.78	1.27	0.18	●	●	●	●	●
22NR N60	5125200	3.50-5.0	1/2	22.10	2.54	1.78	0.25	●	●	●	●	●
22NL N60	5165200	3.50-5.0	1/2	22.10	2.54	1.78	0.25	●	●	●	●	●

LAYDOWN

WHITWORTH

16ER/NR - 3/8" I.C.

w/ patented chipbreaker

Exclusive patented chipbreaker!

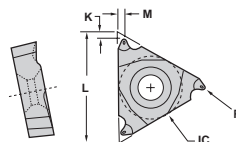

EXT RH SHOWN



Description	EDP Code	TPI	IC	L	M	K	TIN Coated		AlTiN Coated		
							GP22	GP50	AC22	AC3	AC50
16ER 36W-CB	5006036HC	36	3/8	16.00	0.51	1.27	●	●	●	●	●
16ER 32W-CB	5006032HC	32	3/8	16.00	0.51	1.27	●	●	●	●	●
16ER 28W-CB	5006028HC	28	3/8	16.00	0.76	0.76	●	●	●	●	●
16ER 24W-CB	5006024HC	24	3/8	16.00	0.76	0.76	●	●	●	●	●
16ER 20W-CB	5006020HC	20	3/8	16.00	0.76	0.76	●	●	●	●	●
16ER 19W-CB	5006019HC	19	3/8	16.00	0.76	0.76	●	●	●	●	●
16ER 18W-CB	5006018HC	18	3/8	16.00	0.76	0.76	●	●	●	●	●
16ER 16W-CB	5006016HC	16	3/8	16.00	0.76	0.76	●	●	●	●	●
16ER 14W-CB	5006014HC	14	3/8	16.00	1.52	1.27	●	●	●	●	●
16ER 12W-CB	5006012HC	12	3/8	16.00	1.52	1.27	●	●	●	●	●
16ER 11W-CB	5006011HC	11	3/8	16.00	1.52	1.27	●	●	●	●	●
16ER 10W-CB	5006010HC	10	3/8	16.00	1.52	1.27	●	●	●	●	●
16ER 8W-CB	5006008HC	8	3/8	16.00	1.52	1.27	●	●	●	●	●
16NR 28W-CB	5026028HC	28	3/8	16.00	0.76	0.76	●	●	●	●	●
16NR 24W-CB	5026024HC	24	3/8	16.00	0.76	0.76	●	●	●	●	●
16NR 20W-CB	5026020HC	20	3/8	16.00	0.76	0.76	●	●	●	●	●
16NR 19W-CB	5026019HC	19	3/8	16.00	0.76	0.76	●	●	●	●	●

In an effort to improve our stock standard grade offering, there are periodic changes. Please see current price list for up to date grade offering.

● High performance choice in optimal conditions.
▲ Recommended grade under general conditions.

	GP22	GP50	AC22	AC3	AC50
Cast Iron	▲				●
Non-Ferrous	▲				●
Stainless/High Temp	▲				●
Steel		▲			●



LAYDOWN

WHITWORTH

16, 22 & 27ER/NR - 3/8", 1/2" & 5/8" I.C.

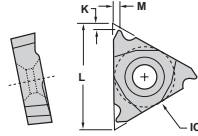

EXT RH SHOWN

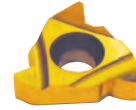

Description	EDP Code	TPI	IC	L	M	K	Coating				
							GP22 TIN Coated	GP50	AC22	AC3 AlTiN Coated	AC50
16ER 28W	5006028	28	3/8	16.00	0.76	0.51	●				●
16ER 20W	5006020	20	3/8	16.00	1.02	0.76	●				●
16ER 19W	5006019	19	3/8	16.00	1.02	0.76	●				●
16ER 18W	5006018	18	3/8	16.00	1.02	0.76	●				●
16ER 16W	5006016	16	3/8	16.00	1.02	1.02	●				●
16ER 14W	5006014	14	3/8	16.00	1.27	1.02	●				●
16ER 12W	5006012	12	3/8	16.00	1.52	1.02	●		●		●
16ER 11W	5006011	11	3/8	16.00	1.52	1.02	●		●		●
16ER 10W	5006010	10	3/8	16.00	1.52	1.02	●	●			●
16ER 9W	5006009	9	3/8	16.00	1.78	1.27	●				●
16ER 8W	5006008	8	3/8	16.00	1.52	1.27	●		●		●
22ER 7W	5106007	7	1/2	22.10	2.29	1.52	●	●			●
22ER 6W	5106006	6	1/2	22.10	2.29	1.52	●				●
22ER 5W	5106005	5	1/2	22.10	2.29	1.78	●		●		●
27ER 4W	5206004	4	5/8	26.92	2.79	2.03	●	●	●		●
16NR 28W	5026028	28	3/8	16.00	0.76	0.51	●				●
16NR 20W	5026020	20	3/8	16.00	1.02	0.76	●				●
16NR 19W	5026019	19	3/8	16.00	1.02	0.76	●				●
16NR 18W	5026018	18	3/8	16.00	1.02	0.76	●				●
16NR 16W	5026016	16	3/8	16.00	1.02	1.02	●	●			●
16NR 14W	5026014	14	3/8	16.00	1.27	1.02	●				●
16NR 12W	5026012	12	3/8	16.00	1.52	1.02	●	●			●
16NR 11W	5026011	11	3/8	16.00	1.52	1.02	●		●		●
16NR 10W	5026010	10	3/8	16.00	1.52	1.02	●	●			●
16NR 9W	5026009	9	3/8	16.00	1.78	1.27	●				●
16NR 8W	5026008	8	3/8	16.00	2.03	1.27	●	●			●
22NR 7W	5126007	7	1/2	22.10	1.52	1.27	●				●
22NR 6W	5126006	6	1/2	22.10	2.29	1.52	●				●
22NR 5W	5126005	5	1/2	22.10	2.29	1.78	●		●		●
27NR 4W	5226004	4	5/8	26.92	2.79	2.03	●				●
							▲				●
							▲				●
							▲				●
							▲				●

In an effort to improve our stock standard grade offering, there are periodic changes. Please see current price list for up to date grade offering.

- High performance choice in optimal conditions.
- ▲ Recommended grade under general conditions.

Cast Iron	▲			●
Non-Ferrous	▲			●
Stainless/High Temp	▲			●
Steel	▲			●

LAYDOWN

EXTERNAL HOLDER AL

For Threading and Grooving

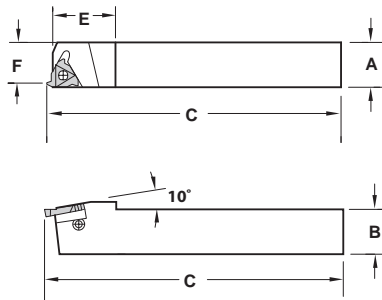

RH Holder uses RH Inserts

Description	EDP Code	Insert	A	B	C	E	F*	Insert Screw	Seat Screw	Wrench	Seat
AL2020M-3R	916120361	16ER	20,0	20,0	125,0	30,0	20,0	SA3	SY3	K3	YE3
AL2020M-3L	916120362	16EL	20,0	20,0	125,0	30,0	20,0	SA3	SY3	K3	YI3
AL2525M-3R	916125361	16ER	25,0	25,0	150,0	30,0	25,0	SA3	SY3	K3	YE3
AL2525M-3L	916125362	16EL	25,0	25,0	150,0	30,0	25,0	SA3	SY3	K3	YI3
AL3232M-3R	916132361	16ER	32,0	32,0	170,0	30,0	32,0	SA3	SY3	K3	YE3
AL3232M-3L	916132362	16EL	32,0	32,0	170,0	30,0	32,0	SA3	SY3	K3	YI3
AL2525M-4R	916125401	22ER	25,0	25,0	150,0	30,0	25,0	SA3	SY3	K3	YE4
AL2525M-4L	916125402	22EL	25,0	25,0	150,0	30,0	25,0	SA4	SY4	K4	YI4
AL3232M-4R	916132401	22ER	32,0	32,0	170,0	30,0	32,0	SA4	SY4	K4	YE4
AL3232M-4L	916132402	22EL	32,0	32,0	170,0	30,0	32,0	SA4	SY4	K4	YI4
AL3232M-5R	916032441	27ER	32,0	32,0	170,0	30,0	32,0	SA5	SY5	K5	YE5
AL3232M-5L	916032442	27EL	32,0	32,0	170,0	30,0	32,0	SA5	SY5	K5	YI5
AL4040M-5R	916040441	27ER	40,0	40,0	200,0	36,0	38,1	SA5	SY5	K5	YE5



INTERNAL BAR AVR/NVR

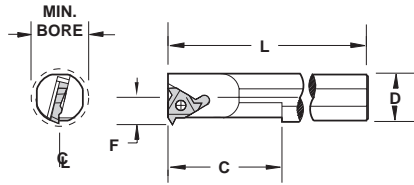

RH SHOWN

Description	EDP Code	Insert	D	F**	L	C	Min. Bore	Insert Screw	Seat Screw & Washer	Wrench	Seat
NVR 10M-2R	962010M351	11NR	10	7.3	180	25	13	SN-2T	-	K2	-
NVR 12M-2R	962012M351	11NR	12	7.3	180	25	14	SN-2T	-	K2	-
NVR 13M-2R	962013M351	11NR	13	8.9	180	32	16	SN-2T	-	K2	-
NVR 13M-2L	962013M352	11NL	13	8.9	180	32	16	SN-2T	-	K2	-
NVR 16M-2R	962016M351	11NR	16	10.3	180	40	18	SN-2T	-	K2	-
NVR 12M-3R	962012M361	16NR	12	10.3	180	32	14	SN-3T	-	K3	-
NVR 13M-3R	962013M361	16NR	13	10.3	180	36	18	SN-3T	-	K3	-
NVR 13M-3L	962013M362	16NL	13	10.3	180	36	18	SN-3T	-	K3	-
NVR 16M-3R	962016M361	16NR	16	11.5	180	40	20	SN-3T	-	K3	-
NVR 16M-3L	962016M362	16NL	16	11.5	180	40	20	SN-3T	-	K3	-
AVR 20M-3R	918020M361	16NR	20	13.4	180	-	26.8	SA3	SY3	K3	YI3
AVR 20M-3L	918020M362	16NL	20	13.4	180	-	26.8	SA3	SY3	K3	YE3
AVR 25M-3R	918025M361	16NR	25	16.3	250	-	32.6	SA3	SY3	K3	YI3
AVR 25M-3L	918025M362	16NL	25	16.3	250	-	32.6	SA3	SY3	K3	YE3
AVR 32M-3R	918032M361	16NR	32	19.5	254	76.2	39.1	SA3	SY3	K3	YI3
AVR 32M-3L	918032M362	16NL	32	19.5	254	76.2	39.1	SA3	SY3	K3	YE3
AVR 40M-3R	918040M361	16NR	40	22.8	304.8	-	45.7	SA3	SY3	K3	YI3
AVR 40M-3L	918040M362	16NL	40	22.8	304.8	-	45.7	SA3	SY3	K3	YE3
NVR 20M-4R	962020M401	22NR	20	13.4	180	-	26.8	SN-3T	-	K3	-
AVR 25M-4R	918025M401	22NR	25	17.4	250	-	34.8	SA4	SY4	K4	YI4
AVR 25M-4L	918025M402	22NL	25	17.4	250	-	34.8	SA4	SY4	K4	YE4
AVR 32M-4R	918032M401	22NR	32	21.3	254	76.2	42.6	SA4	SY4	K4	YI4
AVR 32M-4L	918032M402	22NL	32	21.3	254	76.2	42.6	SA4	SY4	K4	YE4
AVR 40M-4R	918040M401	22NR	40	25.7	300	-	51.5	SA4	SY4	K4	YI4
AVR 40M-4L	918040M402	22NL	40	25.7	300	-	51.5	SA4	SY4	K4	YE4
AVR 50M-4R	918050M401	22NR	50	30.8	350	-	61.6	SA5	SY4	K4	YI4
AVR 50M-4L	918050M402	22NL	50	30.8	350	-	61.6	SA5	SY4	K4	YE4
AVR 50M-5R	918050M41	27NR	50	31.7	350	-	63.5	SA5	SY5	K4	YI5
AVR 50M-5L	918050M42	27NL	50	31.7	350	-	63.5	SA5	SY5	K4	YE5

*Over NV Insert

**Support must be slightly modified if used for grooving.

LAYDOWN

INTERCHANGEABLE HEADS H-AVR/L*

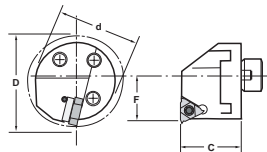

RH SHOWN

PARTS

Description	EDP Code	Insert	D	C	F	Min. Bore	Insert Screw	Seat Screw	Seat
H25M-AVR-3R	9IH18025M361	16NR	25.00	41.28	16.51	30.48	SAM3	SYM3	YI3
H32M-AVR-3R	9IH18032M361	16NR	32.00	41.28	19.43	36.83	SAM3	SYM3	YI3
H40M-AVR-3R	9IH18040M361	16NR	40.00	41.28	22.61	44.70	SAM3	SYM3	YI3
H50M-AVR-3R	9IH18050M361	16NR	50.00	41.28	32.54	60.96	SAM3	SYM3	YI3
H40M-AVR-4R	9IH18040M401	22NR	40.00	41.28	24.84	44.70	SAM4	SYM4	YI4
H50M-AVR-4R	9IH18050M401	22NR	50.00	41.28	32.54	60.96	SAM4	SYM4	YI4

*Left Hand quoted on request.

HS-AVR/L*

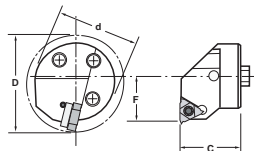

RH SHOWN

PARTS

Description	EDP Code	Insert	D	C	F	Min. Bore	Insert Screw	Seat Screw	Seat
HS25-AVR-3R	9IHS18025M361	16NR	25.00	24.89	16.99	32.00	SAM3	SYM3	YI3
HS32-AVR-3R	9IHS18032M361	16NR	32.00	32.00	22.00	39.88	SAM3	SYM3	YI3
HS40-AVR-3R	9IHS18040M361	16NR	40.00	32.00	27.00	50.04	SAM3	SYM3	YI3
HS50-AVR-3R	9IHS18050M361	16NR	50.00	39.88	35.00	62.99	SAM3	SYM3	YI3
HS40-AVR-4R	9IHS18040M401	22NR	40.00	32.00	27.00	50.04	SAM4	SYM4	YI4
HS50-AVR-4R	9IHS18050M401	22NR	50.00	39.88	35.00	62.99	SAM4	SYM4	YI4

*Left Hand quoted on request.



ANVILS

Resultant Helix Angle	4.5°	3.5°	2.5°	1.5°	0.5°	0°	-0.5°	-1.5°
-----------------------	------	------	------	------	------	----	-------	-------

IC	L (mm)	Holder	Anvil Description							
3/8"	16.00 16.00	ER/NL EL/NR	YE3-3P YI3-3P	YE3-2P YI3-2P	YE3-1P YI3-1P	YE3 YI3	YE3-1N YI3-1N	YE3-1.5N YI3-1.5N	YE3-2N YI3-2N	YE3-3N YI3-3N
1/2"	22.00 22.00	ER/NL EL/NR	YE4-3P YI4-3P	YE4-2P YI4-2P	YE4-1P YI4-1P	YE4 YI4	YE4-1N YI4-1N	YE4-1.5N YI4-1.5N	YE4-2N YI4-2N	YE4-3N YI4-3N
5/8"	27.00 27.00	ER/NL EL/NR	YE5-3P YI5-3P	YE5-2P YI5-2P	YE5-1P YI5-1P	YE5 YI5	YE5-1N YI5-1N	YE5-1.5N YI5-1.5N	YE5-2N YI5-2N	YE5-3N YI5-3N
3/8"M	16.00 16.00	ER/NL EL/NR				YE3M YI3M	YE3M-1N YI3M-1N	YE3M-1.5N YI3M-1.5N	YE3M-2N	
1/2"M	22.00 22.00	ER/NL EL/NR				YE4M YI4M	YE4M-1N YI4M-1N	YE4M-1.5N YI4M-1.5N	YE4M-2N	
5/8"M	27.00 27.00	ER/NL EL/NR				YE5M YI5M	YE5M-1N YI5M-1N	YE5M-1.5N YI5M-1.5N		
1/2"Z	22.00	EL/NR			YI4Z-1P					
1/2"U	22.00 22.00	ER/NL EL/NR	YE4U-3P YI4U-3P	YE4U-2P YI4U-2P	YE4U-1P YI4U-1P	YE4U YI4U	YE4U-1N YI4U-1N	YE4U-1.5N YI4U-1.5N	YE4U-2N YI4U-2N	YE4U-3N YI4U-3N

IC	L	TF #	Included Anvils
ANVIL KITS	3/8"	16.00	KTY3
			YE3-2P, 1P, 1N, 2N, 3N YI3-2P, 1P, 1N, 2N, 3N
	1/2"	22.00	KTY4
			YE4-2P, 1P, 1N, 2N, 3N YI4-2P, 1P, 1N, 2N, 3N
	1/2"U	22.00	KTY4U
			YE4U-2P, 1P, 1N, 2N, 3N YI4U-2P, 1P, 1N, 2N, 3N
5/8"	27.00	KTYE5	
		YE5-2P, 1P, 1N, 2N, 3N YI5-2P, 1P, 1N, 2N, 3N	
5/8"U	27.00	KTYE5U	
		YE5U-2P, 1P, 1N, 2N, 3N YI5U-2P, 1P, 1N, 2N, 3N	

Standard Anvil		M Style Anvil		Z Style Anvil	
ER/NL	EL/NR	ER/NL	EL/NR	ER/NL	EL/NR

ANVIL FORMS	
1/2"	YE4-11.5NPT-2M YI4-11.5NPT-2M
5/8"	YE5-8NPT-2M, YE5-8RD-2M YI5-8NPT-2M, YI5-8RD-2M

Helix Angle Diagram

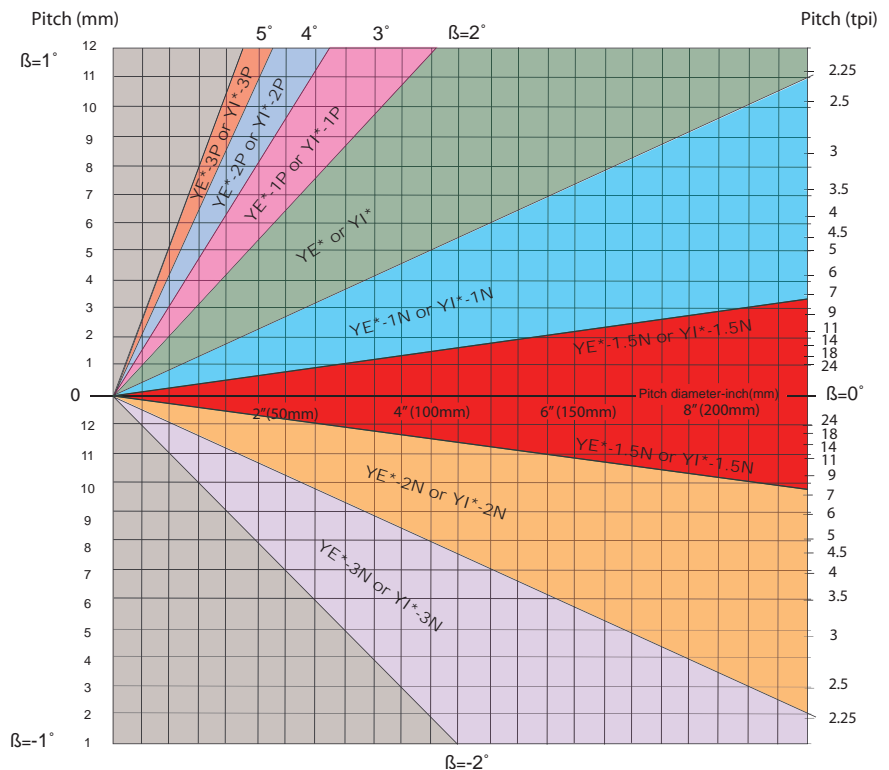

LAYDOWN



SELECTION OF SHIMS

To calculate the lead angle of a given thread, use this formula:

$$\beta = \text{Arctan} \frac{P \times S}{\pi D_e}$$

β = Thread lead angle

D_e = effective pitch diameter of thread
where $P = 1/\text{tpi}$

tpi = Threads per inch

S = number of starts (=1 for standard thread)

P = pitch

multiple-start, lead = $P \times S$

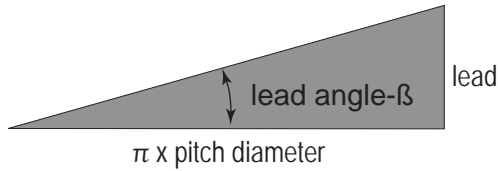
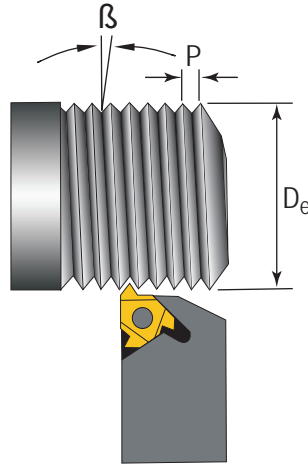

Feed direction towards the chuck

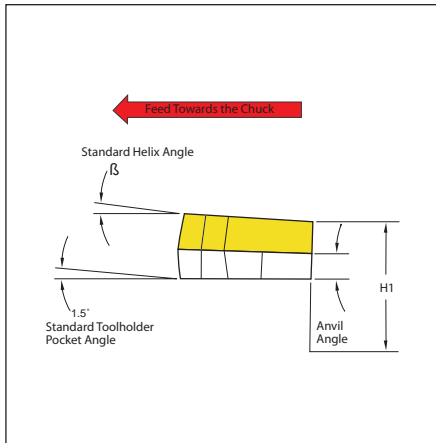

RH Tooling	External RH Thread <ul style="list-style-type: none"> counterclockwise rotation right hand toolholder right hand insert
	Internal RH Thread <ul style="list-style-type: none"> counterclockwise rotation right hand bar right hand insert

LH Tooling	External LH Thread <ul style="list-style-type: none"> clockwise rotation left hand toolholder left hand insert
	Internal LH Thread <ul style="list-style-type: none"> clockwise rotation left hand bar left hand insert

Feed direction towards the tailstock

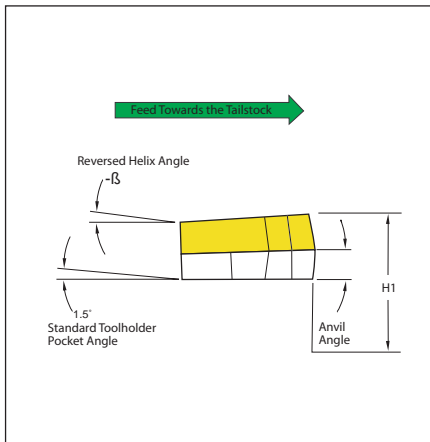

RH Tooling	External LH Thread <ul style="list-style-type: none"> counterclockwise rotation right hand toolholder right hand insert
	Internal LH Thread <ul style="list-style-type: none"> counterclockwise rotation right hand bar right hand insert

LH Tooling	External RH Thread <ul style="list-style-type: none"> clockwise rotation left hand toolholder left hand insert
	Internal RH Thread <ul style="list-style-type: none"> clockwise rotation left hand bar left hand insert



LAYDOWN

L-Style Laydown Insert Nomenclature Chart

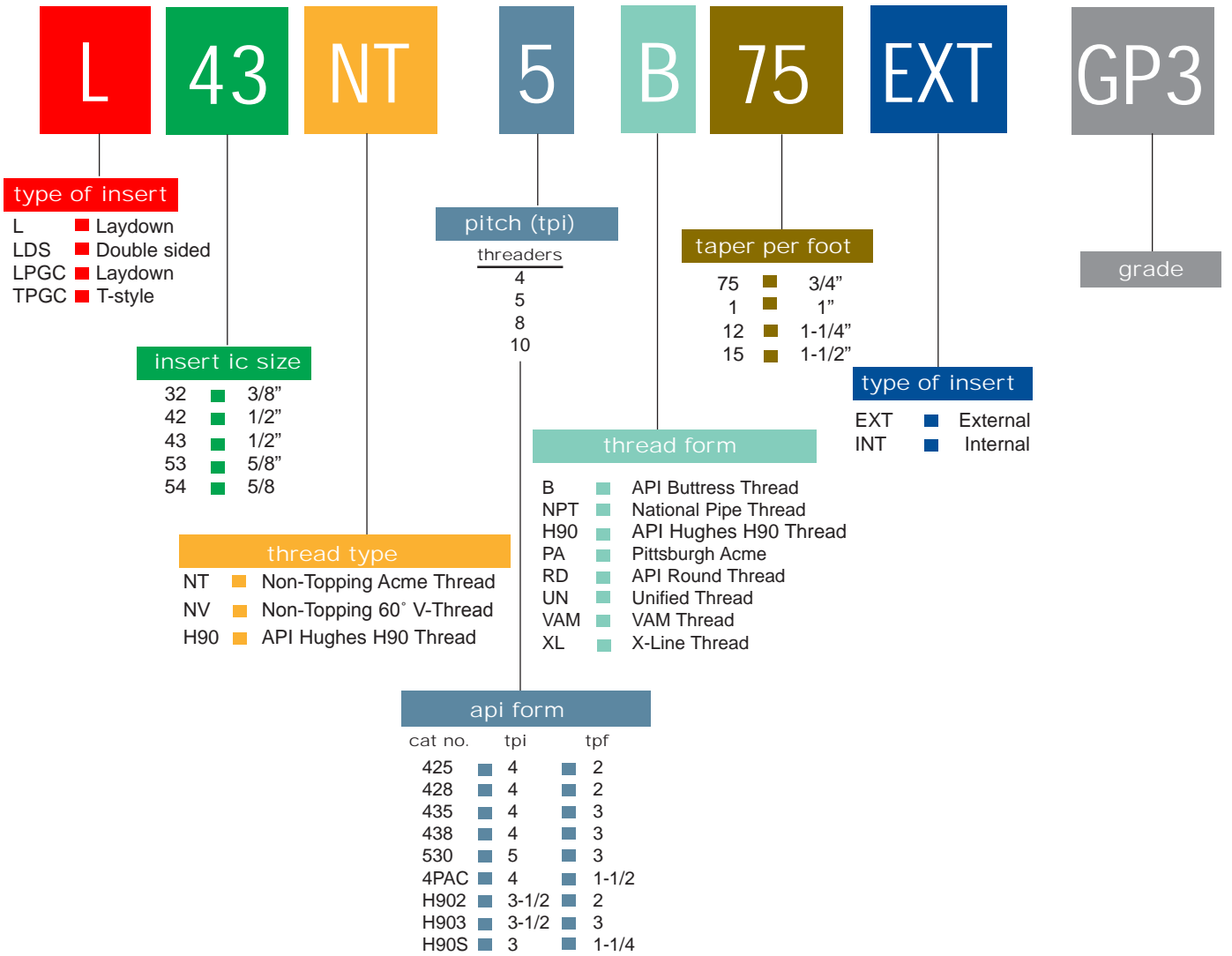

LAYDOWN

ACME L43/L53 - 1/2" & 5/8" I.C.

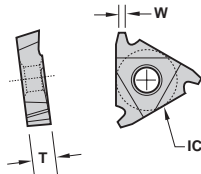

EXT SHOWN
INT OPPOSITE



Description	EDP Code	TPI	W	IC	T	TiN Coated		AlTiN Coated	
						GP22	GP50	GP5	AC22
L43 NT 8P EXT	0215C080	8	1.04	1/2	4.80	●	●		
L43 NT 6P EXT	0215C060	6	1.44	1/2	4.80	●	●		
L43 NT 5P EXT	0215C050	5	1.75	1/2	4.80	●	●		
L53 NT 4P EXT	0247C040	4	2.22	5/8	4.80	●	●		
L43 NT 8P INT	0215A080	8	1.04	1/2	4.80	●	●		●
L43 NT 6P INT	0215A060	6	1.44	1/2	4.80	●	●		●
L43 NT 5P INT	0215A050	5	1.75	1/2	4.80	●	●		●
L53 NT 4P INT	0247A040	4	2.22	5/8	4.80	●	●		●

In an effort to improve our stock standard grade offering, there are periodic changes. Please see current price list for up to date grade offering.

- High performance choice in optimal conditions.
- ▲ Recommended grade under general conditions.

Cast Iron	▲				●
Non-Ferrous	▲				●
Stainless/High Temp	▲				●
Steel	▲				●



ACME

LPGC 32, 42 & 43 - 3/8" & 1/2 I.C.

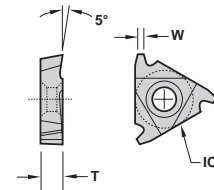

EXT SHOWN
INT OPPOSITE

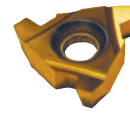

Description	EDP Code	TPI	W	IC	T	TIN Coated			A/TIN Coated		
						GP22	GP50	GP5	AC22	AC3	AC50
LPGC 32 NT 12P INT RH	0204A120	12	0.72	3/8	3.23			●			
LPGC 32 NT 10P INT RH	0204A100	10	0.81	3/8	3.23			●			
LPGC 32 NT 8P INT RH	0204A080	8	1.04	3/8	3.23			●			
LPGC 42 NT 8P INT RH	0213A080	8	1.04	1/2	3.23			●			
LPGC 42 NT 6P INT RH	0213A060	6	1.44	1/2	3.23			●			
LPGC 42 NT 5P INT RH	0213A050	5	1.75	1/2	3.23			●			
LPGC 42 NT 4P INT RH*	0213A040	4	2.22	1/2	3.23			●			
LPGC 43 NT 8P INT RH	0227A080	8	1.04	1/2	4.80			●			
LPGC 43 NT 6P INT RH	0227A060	6	1.44	1/2	4.80			●			
LPGC 43 NT 5P INT RH	0227A050	5	1.75	1/2	4.80			●			
LPGC 43 NT 4P INT RH*	0227A040	4	2.22	1/2	4.80			●			

*Bar must be modified to clear depth.

TPGC 32, 42 & 43 - 3/8" & 1/2 I.C.

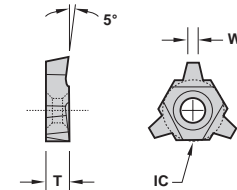

Description	EDP Code	TPI	W	IC	T	TIN Coated			A/TIN Coated		
						GP22	GP50	GP5	AC22	AC3	AC50
TPGC 32 NT 10P	0207100	10	0.81	3/8	3.23			●			
TPGC 32 NT 8P	0207080	8	1.04	3/8	3.23			●			
TPGC 32 NT 6P	0207060	6	1.44	3/8	3.23			●			
TPGC 32 NT 5P	0207050	5	1.75	3/8	3.23			●			
TPGC 42 NT 8P	0214080	8	1.04	1/2	3.23			●			
TPGC 42 NT 6P	0214060	6	1.44	1/2	3.23			●			
TPGC 42 NT 5P	0214050	5	1.75	1/2	3.23			●			
TPGC 42 NT 4P	0214040	4	2.22	1/2	3.23			●			
TPGC 43 NT 5P	0238050	5	1.75	1/2	4.80			●			
TPGC 43 NT 4P	0238040	4	2.22	1/2	4.80			●			

ACME STUB

L43/L53 - 1/2" & 5/8" I.C.

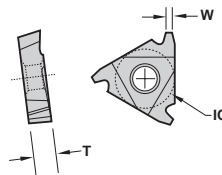

INT SHOWN
EXT OPPOSITE



Description	EDP Code	TPI	W	IC	T	TIN Coated			A/TIN Coated		
						GP22	GP50	GP54	AC22	AC3	AC50
L43 NT 8P STUB EXT	0215C081	8	1.21	1/2	4.80		●				
L43 NT 6P STUB EXT	0215C061	6	1.66	1/2	4.80		●				
L43 NT 5P STUB EXT	0215C051	5	2.01	1/2	4.80		●				
L53 NT 4P STUB EXT	0247C041	4	2.55	5/8	4.80		●				
L43 NT 8P STUB INT	0215A081	8	1.21	1/2	4.80		●				
L43 NT 6P STUB INT	0215A061	6	1.66	1/2	4.80		●				
L43 NT 5P STUB INT	0215A051	5	2.01	1/2	4.80		●				
L53 NT 4P STUB INT	0247A041	4	2.55	5/8	4.80		●				

LPGC 32, 42 & 43 - 3/8" & 1/2 I.C.

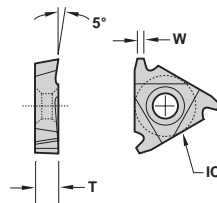

EXT SHOWN
INT OPPOSITE

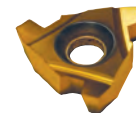

Description	EDP Code	TPI	W	IC	T	TIN Coated			A/TIN Coated		
						GP22	GP5	GP50	AC25	AC3	AC50
LPGC 32 NT 8P STUB INT RH	0204A081	8	1.21	3/8	3.23		●	●			
LPGC 42 NT 8P STUB INT RH	0213A081	8	1.21	1/2	3.23		●	●			
LPGC 42 NT 6P STUB INT RH	0213A061	6	1.66	1/2	3.23		●	●			
LPGC 42 NT 5P STUB INT RH	0213A051	5	2.01	1/2	3.23		●	●			
LPGC 42 NT 4P STUB INT RH	0213A041	4	2.55	1/2	3.23		●	●			
LPGC 43 NT 8P STUB INT RH	0227A081	8	1.21	1/2	4.80		●	●			
LPGC 43 NT 6P STUB INT RH	0227A061	6	1.66	1/2	4.80		●	●			
LPGC 43 NT 5P STUB INT RH	0227A051	5	2.01	1/2	4.80		●	●			
LPGC 43 NT 4P STUB INT RH	0227A041	4	2.55	1/2	4.80		●	●			

In an effort to improve our stock standard grade offering, there are periodic changes. Please see current price list for up to date grade offering.

- High performance choice in optimal conditions.
- ▲ Recommended grade under general conditions.

Cast Iron
Non-Ferrous
Stainless/High Temp
Steel



LAYDOWN

ACME STUB TPGC 32, 42 & 43 - 3/8" & 1/2 I.C.

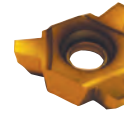
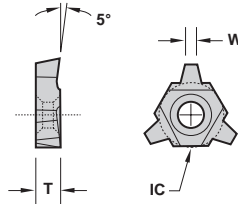

Description	EDP Code	TPI	W	IC	T	TIN Coated			A/TIN Coated		
						GP22	GP5	GP50	AC22	AC3	AC50
TPGC 32 NT 8P STUB	0207081	8	1.21	3/8	3.23	●	●				
TPGC 32 NT 6P STUB	0207061	6	1.66	3/8	3.23	●	●				
TPGC 32 NT 5P STUB	0207051	5	2.01	3/8	3.23	●	●				
TPGC 42 NT 8P STUB	0214081	8	1.21	1/2	3.23	●	●				
TPGC 42 NT 6P STUB	0214061	6	1.66	1/2	3.23	●	●				
TPGC 42 NT 5P STUB	0214051	5	2.01	1/2	3.23	●	●				
TPGC 42 NT 4P STUB	0214041	4	2.55	1/2	3.23	●	●				
TPGC 43 NT 5P STUB	0238051	5	2.01	1/2	4.80	●	●				
TPGC 43 NT 4P STUB	0238041	4	2.55	1/2	4.80	●	●				

API BUTTRESS L43/L53 - 1/2" & 5/8" I.C.

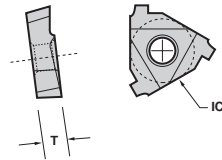

EXT SHOWN
INT OPPOSITE

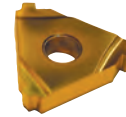

Description	EDP Code	TPI	TPF	IC	T	Conn. No.	TIN Coated			A/TIN Coated		
							GP22	GP50	GP54	AC22	AC3	AC50
L43 5B75 EXT-FC	16154F	5	3/4	1/2	4.80	4-1/2 - 13-3/8	●	●				
L43 5B1 EXT -FC	17154F	5	1	1/2	4.80	16 and larger	●	●		●	●	
L43 8B75 EXT-FC	21154F	8	3/4	1/2	4.80	US Improved Buttress	●	●				
L53 5B75 EXT-FC	16474F	5	3/4	5/8	4.80	4-1/2 - 13-3/8	●	●		●	●	
L53 5B1 EXT-FC	17474F	5	1	5/8	4.80	16 and larger	●	●				
L53 8B75 EXT-FC	21474F	8	3/4	5/8	4.80	US Improved Buttress	●	●				
L43 5B75 INT-FC	16158F	5	3/4	1/2	4.80	4-1/2 - 13-3/8	●	●				
L43 5B1 INT-FC	17158F	5	1	1/2	4.80	16 and larger	●	●		●	●	
L43 8B75 INT-FC	21158F	8	3/4	1/2	4.80	US Improved Buttress	●	●				
L53 5B75 INT-FC	16478F	5	3/4	5/8	4.80	4-1/2 - 13-3/8	●	●		●	●	
L53 5B1 INT-FC	17478F	5	1	5/8	4.80	16 and larger	●	●				
L53 8B75 INT-FC	21478F	8	3/4	5/8	4.80	US Improved Buttress	●	●		●	●	

FC designates 5° flank clearance

API HUGHES H90 L53 - 5/8" I.C.

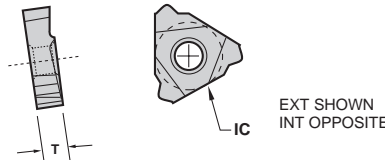

EXT SHOWN
INT OPPOSITE

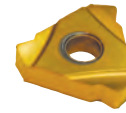

Description	EDP Code	TPI	TPF	IC	T	Conn. No.	TIN Coated			A/TIN Coated		
							GP22	GP50	GP54	AC22	AC3	AC50
L53 H902 EXT	28474	3-1/2	2	5/8	4.80	3-1/2 - 6-5/8 H90		●				
L53 H903 EXT	29474	3-1/2	3	5/8	4.80	7 - 8-5/8 H90		●				
L53 H90S EXT	27474	3	1-1/4	5/8	4.80	2-3/8 - 3-1/2 Slimline		●				
L53 H902 INT	28478	3-1/2	2	5/8	4.80	3-1/2 - 6-5/8 H90		●				
L53 H903 INT	29478	3-1/2	3	5/8	4.80	7 - 8-5/8 H90		●				
L53 H90S INT	27478	3	1-1/4	5/8	4.80	2-3/8 - 3-1/2 Slimline		●				

LDS 54 - 5/8 I.C. Double Sided

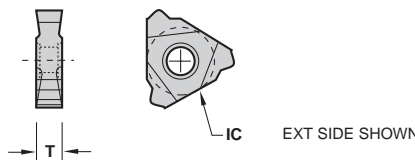

EXT SIDE SHOWN

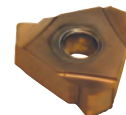

Description	EDP Code	TPI	TPF	IC	T	Conn. No.	TIN Coated			A/TIN Coated		
							GP22	GP50	GP54	AC22	AC3	AC50
LDS 54 H902	28490	3-1/2	2	5/8	6.40	3-1/2 - 6-5/8 H90			●			
LDS 54 H903	29490	3-1/2	3	5/8	6.40	7 - 8-5/8 H90			●			
LDS 54 H90S	27490	3	1-1/4	5/8	6.40	2-3/8 - 3-1/2 Slimline			●			

In an effort to improve our stock standard grade offering, there are periodic changes. Please see current price list for up to date grade offering.

- High performance choice in optimal conditions.
- ▲ Recommended grade under general conditions.

Cast Iron												
Non-Ferrous												
Stainless/High Temp												
Steel									▲			



API ROTARY SHOULDER CONNECTION

L43/53 - 1/2" & 5/8" I.C.

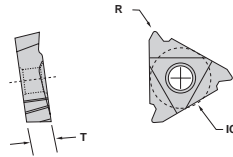

EXT SHOWN
INT OPPOSITE

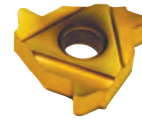

■ Must be used with API bars.

Description	EDP Code	TPI	TPF	R	IC	T	Connection	TIN Coated		A/TIN Coated	
								GP50	GP54	AC22	AC3
L43 425 EXT	09154	4	2	0.64	1/2	4.80	5-1/2 FH 6-5/8 FH 6-5/8 Reg.	●		●	●
L43 428 EXT	10154	4	2	0.97	1/2	4.80	NC 23-NC50 2-3/8 - 5-1/2 IF	●		●	●
L43 42F EXT*	14154	4	2	---	1/2	4.80	V0.065*				
L43 435 EXT	11154	4	3	0.64	1/2	4.80	5-1/2 Rg. 7-5/8 Reg. 8-5/8 Reg.	●		●	●
L43 438 EXT	12154	4	3	0.97	1/2	4.80	NC56 - NC71	●		●	●
L43 530 EXT	13154	5	3	0.51	1/2	4.80	3-1/2 FH 2-3/8 - 4-1/2 Reg.	●		●	●
L43 4PAC EXT	15154	4	1-1/2	---	1/2	4.80	American Open Hole	●			
L53 425 EXT	09474	4	2	0.64	5/8	4.80	5-1/2 FH 6-5/8 FH 6-5/8 Reg.	●		●	●
L53 428 EXT	10474	4	2	0.97	5/8	4.80	NC 23-NC50 2-3/8 - 5-1/2 IF	●		●	●
L53 42F EXT*	14474	4	2	---	5/8	4.80	V0.065*				
L53 435 EXT	11474	4	3	0.64	5/8	4.80	5-1/2 Rg. 7-5/8 Reg. 8-5/8 Reg.	●		●	●
L53 438 EXT	12474	4	3	0.97	5/8	4.80	NC56 - NC71	●		●	●
L53 530 EXT	13474	5	3	0.51	5/8	4.80	3-1/2 FH 2-3/8 - 4-1/2 Reg.	●		●	●
L53 4PAC EXT	15474	4	1-1/2	---	5/8	4.80	American Open Hole	●			
L43 425 INT	09158	4	2	0.64	1/2	4.80	5-1/2 FH 6-5/8 FH 6-5/8 Reg.	●		●	●
L43 428 INT	10158	4	2	0.97	1/2	4.80	NC 23-NC50 2-3/8 - 5-1/2 IF	●		●	●
L43 42F INT*	14158	4	2	---	1/2	4.80	V0.065*				
L43 435 INT	11158	4	3	0.64	1/2	4.80	5-1/2 Rg. 7-5/8 Reg. 8-5/8 Reg.	●		●	●
L43 438 INT	12158	4	3	0.97	1/2	4.80	NC56 - NC71	●		●	●
L43 530 INT	13158	5	3	0.51	1/2	4.80	3-1/2 FH 2-3/8 - 4-1/2 Reg.	●		●	●
L43 4PAC INT	15158	4	1-1/2	---	1/2	4.80	American Open Hole	●			
L53 425 INT	09478	4	2	0.64	5/8	4.80	5-1/2 FH 6-5/8 FH 6-5/8 Reg.	●		●	●
L53 428 INT	10478	4	2	0.97	5/8	4.80	NC 23-NC50 2-3/8 - 5-1/2 IF	●		●	●
L53 42F INT*	14478	4	2	---	5/8	4.80	V0.065*				
L53 435 INT	11478	4	3	0.64	5/8	4.80	5-1/2 Rg. 7-5/8 Reg. 8-5/8 Reg.	●		●	●
L53 438 INT	12478	4	3	0.97	5/8	4.80	NC56 - NC71	●		●	●
L53 530 INT	13478	5	3	0.51	5/8	4.80	3-1/2 FH 2-3/8 - 4-1/2 Reg.	●		●	●
L53 4PAC INT	15478	4	1-1/2	---	5/8	4.80	American Open Hole	●			

* Obsolete thread form, See A.P.I. Spec 7, 35th Edition, May 1, 1995, Section 9.4

LAYDOWN

LDS 54 Double Sided Lead Follow Topping Internal/External with patented chipbreaker

Exclusive patented design!

■ For holders see pg. 132-134

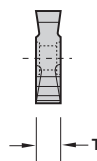
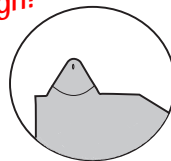

EXT SIDE SHOWN

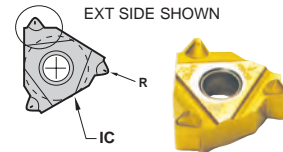

Description	EDP Code	TPI	TPF	R	IC	T	Connection	TIN Coated		A/TIN Coated		
								GP54	AC22	AC3	AC50	AC54
LDS 54 428-CB #1	10490HC	4	2	0.97	5/8	6.40	NC23-NC50, 2-3/8-5-1/2 IF	●	●	●	●	●
LDS 54 438-CB #2	12490HC	4	3	0.97	5/8	6.40	NC56-NC71	●	●	●	●	●
LDS 54 425-CB #3	09490HC	4	2	0.64	5/8	6.40	5-1/2 FH, 6-5/8 FH, 6-5/8 Reg.	●	●	●	●	●
LDS 54 435-CB #4	11490HC	4	3	0.64	5/8	6.40	5-1/2 Reg. 7-5/8 Reg 8-5/8 Reg.	●	●	●	●	●
LDS 54 530-CB #5	13490HC	5	3	0.51	5/8	6.40	3-1/2 FH 2-3/8 - 4-1/2 Reg.	●	●	●	●	●

LDS 54 Double Sided Follow Topping Internal/External with patented chipbreaker

Exclusive patented design!

■ For holders see pg. 132-134

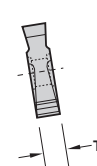
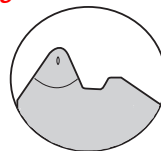

EXT SIDE SHOWN



Description	EDP Code	TPI	TPF	R	IC	T	Connection	TIN Coated		A/TIN Coated		
								GP54	AC22	AC3	AC50	AC54
LDS 54 428 FT-CB #1	10495HC	4	2	0.97	5/8	6.40	NC23-NC50, 2-3/8-5-1/2 IF	●	●	●	●	●
LDS 54 438 FT-CB #2	12495HC	4	3	0.97	5/8	6.40	NC56-NC71	●	●	●	●	●
LDS 54 425 FT-CB #3	09495HC	4	2	0.64	5/8	6.40	5-1/2 FH, 6-5/8 FH, 6-5/8 Reg.	●	●	●	●	●
LDS 54 435 FT-CB #4	11495HC	4	3	0.64	5/8	6.40	5-1/2 Reg. 7-5/8 Reg 8-5/8 Reg.	●	●	●	●	●
LDS 54 530 FT-CB #5	13495HC	5	3	0.51	5/8	6.40	3-1/2 FH 2-3/8 - 4-1/2 Reg.	●	●	●	●	●

In an effort to improve our stock standard grade offering, there are periodic changes. Please see current price list for up to date grade offering.

- High performance choice in optimal conditions.
- ▲ Recommended grade under general conditions.

	Cast Iron	Non-Ferrous	Stainless/High Temp	Steel
●		●	●	
▲		●	●	●



LAYDOWN

API ROTARY SHOULDER CONNECTION

LDS 54 - 5/8" I.C.
Double Sided
Full Topping

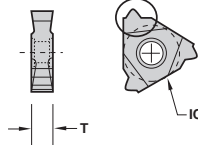
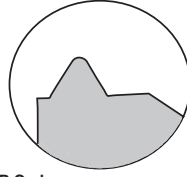

EXT SIDE SHOWN



Description	EDP Code	TPI	TPF	IC	T	Conn. No.	TIN Coated		A/TIN Coated			
							GP22	GP54	AC22	AC3	AC50	AC54
LDS 54 428 #1	10490	4	2	5/8	6.40	NC23-NC50, 2-3/8-5-1/2 IF	●	●	●	●	●	●
LDS 54 438 #2	12490	4	3	5/8	6.40	NC56-NC71	●	●	●	●	●	●
LDS 54 425 #3	09490	4	2	5/8	6.40	5-1/2 FH, 6-5/8 FH, 6-5/8 Reg.	●	●	●	●	●	●
LDS 54 435 #4	11490	4	3	5/8	6.40	5-1/2 Reg. 7-5/8 Reg 8-5/8 Reg.	●	●	●	●	●	●
LDS 54 530 #5	13490	5	3	5/8	6.40	3-1/2 FH 2-3/8 - 4-1/2 Reg.	●	●	●	●	●	●
LDS 54 42F*	14490	4	2	5/8	6.40	V0.065*	●	●	●	●	●	●
LDS 54 4PAC	15490	4	1-1/2	5/8	6.40	American Open Hole	●	●	●	●	●	●

* Obsolete thread form, See A.P.I. Spec 7, 35th Edition, May 1, 1995, Section 9.4

LDS 54 - 5/8" I.C.
Double Sided
Follow Topping

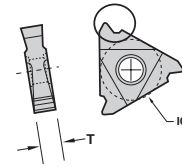
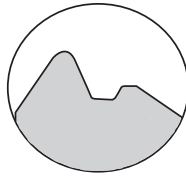

EXT SIDE SHOWN

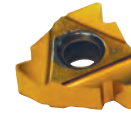

Description	EDP Code	TPI	TPF	IC	T	Conn. No.	TIN Coated		A/TIN Coated			
							GP22	GP54	AC22	AC3	AC50	AC54
LDS 54 428 #1 FT	10495	4	2	5/8	6.40	NC23-NC50, 2-3/8-5-1/2 IF	●	●	●	●	●	●
LDS 54 438 #2 FT	12495	4	3	5/8	6.40	NC56-NC71	●	●	●	●	●	●
LDS 54 425 #3 FT	09495	4	2	5/8	6.40	5-1/2 FH, 6-5/8 FH, 6-5/8 Reg.	●	●	●	●	●	●
LDS 54 435 #4 FT	11495	4	3	5/8	6.40	5-1/2 Reg. 7-5/8 Reg 8-5/8 Reg.	●	●	●	●	●	●
LDS 54 530 #5 FT	13495	5	3	5/8	6.40	3-1/2 FH 2-3/8 - 4-1/2 Reg.	●	●	●	●	●	●
LDS 54 42F* FT	14495	4	2	5/8	6.40	V0.065*	●	●	●	●	●	●
LDS 54 4PAC FT	15495	4	1-1/2	5/8	6.40	American Open Hole	●	●	●	●	●	●

* Obsolete thread form, See A.P.I. Spec 7, 35th Edition, May 1, 1995, Section 9.4

API ROUND L43/L53 - 1/2" & 5/8" I.C.

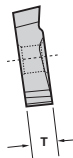

EXT SIDE SHOWN

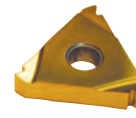

Description	EDP Code	TPI	TPF	IC	T	TIN Coated		A/TIN Coated			
						GP22	GP50	GP54	AC22	AC3	AC50
L43 10RD EXT	34154	10	3/4	1/2	4.80	●	●	●	●	●	●
L43 8RD EXT	32154	8	3/4	1/2	4.80	●	●	●	●	●	●
L53 8RD EXT	32474	8	3/4	5/8	4.80	●	●	●	●	●	●
L43 8RD INT	32158	8	3/4	1/2	4.80	●	●	●	●	●	●
L43 10RD INT	34158	10	3/4	1/2	4.80	●	●	●	●	●	●
L53 8RD INT	32478	8	3/4	5/8	4.80	●	●	●	●	●	●

LDS 43 & 54 - 1/2" & 5/8" I.C.
Double Sided

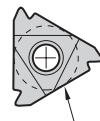
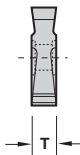

EXT SIDE SHOWN

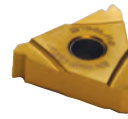

Description	EDP Code	TPI	TPF	IC	T	TIN Coated		A/TIN Coated			
						GP22	GP50	GP54	AC22	AC3	AC50
LDS 43 10RD	34180	10	3/4	1/2	4.80	●	●	●	●	●	●
LDS 43 8RD	32180	8	3/4	1/2	4.80	●	●	●	●	●	●
LDS 54 10RD	34490	10	3/4	5/8	6.40	●	●	●	●	●	●
LDS 54 8RD	32490	8	3/4	5/8	6.40	●	●	●	●	●	●

LDS 54 - 5/8" I.C.
Double Sided
Internal/External
with patented chipbreaker

Exclusive patented design!

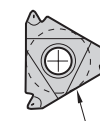
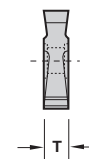

EXT SIDE SHOWN



Description	EDP Code	TPI	TPF	IC	T	TIN Coated		A/TIN Coated			
						GP22	GP50	GP54	AC22	AC3	AC50
LDS 54 10RD-CB	34490	10	3/4	5/8	6.40	●	●	●	●	●	●
LDS 54 8RD-CB	32490	8	3/4	5/8	6.40	●	●	●	●	●	●



API ROUND TNFA 43 - 1/2" I.C.

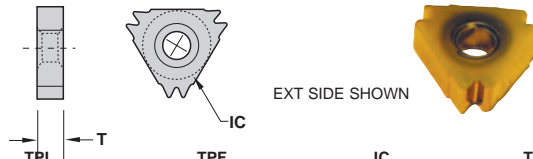

Description	EDP Code	TPI	TPF	IC	T	GP22	GP50	GP54	AC22	AC3	AC50
TNFA 43 8RD	32N70	8	3/4	1/2	4.75		●			●	●

TIN Coated			A1TIN Coated		
GP22	GP50	GP54	AC22	AC3	AC50

API VAM L43 - 1/2" I.C.

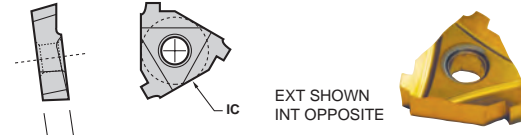

Description	EDP Code	TPI	TPF	IC	T	GP22	GP50	GP54	AC22	AC3	AC50
L43 5VAM EXT	23154	5	3/4	1/2	4.80						
L43 6VAM EXT	24154	6	3/4	1/2	4.80	●					
L43 8VAM EXT	25154	8	3/4	1/2	4.80	●					
L43 5VAM INT	23158	5	3/4	1/2	4.80						
L43 6VAM INT	24158	6	3/4	1/2	4.80	●					
L43 8VAM INT	25158	8	3/4	1/2	4.80	●					

TIN Coated			A1TIN Coated		
GP22	GP50	GP54	AC22	AC3	AC50

API X-LINE L43/L53 - 1/2" & 5/8" I.C.

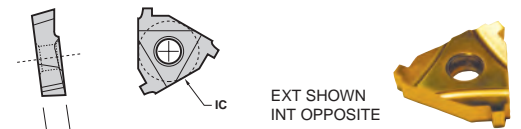

Description	EDP Code	TPI	TPF	IC	T	Conn. No.	GP22	GP50	GP54	AC22	AC3	AC50
L43 6XL15 EXT	19154	6	1-1/2	1/2	4.80	5 - 7-5/8		●				
L43 6XL75 EXT	20154	6	3/4	1/2	4.80	-		●				
L43 5XL12 EXT	18154	5	1-1/4	1/2	4.80	8-5/8 - 10-3/4		●				
L53 6XL15 EXT	19474	6	1-1/2	5/8	4.80	5 - 7-5/8		●				
L53 6XL75 EXT	20474	6	3/4	5/8	4.80	-		●				
L53 5XL12 EXT	18474	5	1-1/4	5/8	4.80	8-5/8 - 10-3/4		●				
L43 6XL15 INT	19158	6	1-1/2	1/2	4.80	5 - 7-5/8		●				
L43 6XL75 INT	20158	6	3/4	1/2	4.80	-		●				
L43 5XL12 INT	18158	5	1-1/4	1/2	4.80	8-5/8 - 10-3/4		●				
L53 6XL15 INT	19478	6	1-1/2	5/8	4.80	5 - 7-5/8		●				
L53 6XL75 INT	20478	6	3/4	5/8	4.80	-		●				
L53 5XL12 INT	18478	5	1-1/4	5/8	4.80	8-5/8 - 10-3/4		●				

TIN Coated			A1TIN Coated		
GP22	GP50	GP54	AC22	AC3	AC50

NPT L43 - 1/2" I.C.

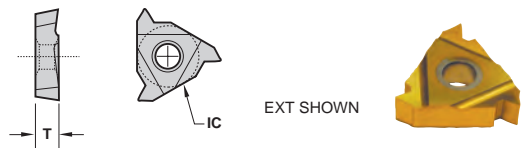

Description	EDP Code	TPI	TPF	IC	T	GP22	GP50	GP54	AC22	AC3	AC50
L43 11.5NPT EXT	3615114	11.5	3/4	1/2	4.80		●				
L43 8NPT EXT	3615084	8	3/4	1/2	4.80		●				
L43 11.5NPT INT	3615118	11.5	3/4	1/2	4.80		●				●
L43 8NPT INT	3615088	8	3/4	1/2	4.80		●				

TIN Coated			A1TIN Coated		
GP22	GP50	GP54	AC22	AC3	AC50

L43 - 1/2" I.C. Multi-Tooth

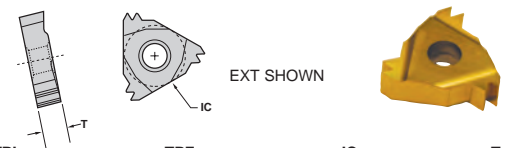

Description	EDP Code	TPI	TPF	IC	T	GP22	GP50	GP54	AC22	AC3	AC50
L43 11.5NPT2M EXT	3615114T	11.5	3/4	1/2	4.80		●				
L43 11.5NPT2M INT	3615118T	11.5	3/4	1/2	4.80		●		●		●

TIN Coated			A1TIN Coated		
GP22	GP50	GP54	AC22	AC3	AC50

LDS 43 - 1/2" I.C. Double Sided

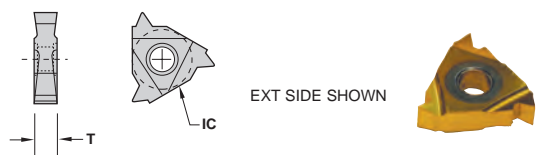

Description	EDP Code	TPI	TPF	IC	T	GP22	GP50	GP54	AC22	AC3	AC50
LDS 43 14NPT	3618140	14	3/4	1/2	4.80			●			
LDS 43 11.5NPT	3618110	11.5	3/4	1/2	4.80			●			
LDS 43 8NPT	3618080	8	3/4	1/2	4.80			●			

TIN Coated			A1TIN Coated		
GP22	GP50	GP54	AC22	AC3	AC50

In an effort to improve our stock standard grade offering, there are periodic changes. Please see current price list for up to date grade offering.

- High performance choice in optimal conditions.
- ▲ Recommended grade under general conditions.

Cast Iron					
Non-Ferrous					
Stainless/High Temp					
Steel					



LAYDOWN

PITTSBURGH ACME L43/L53 - 1/2" & 5/8" I.C.

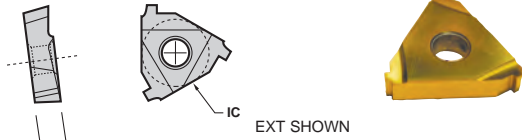

Description	EDP Code	TPI	TPF	IC	T	TIN Coated			A1TIN Coated		
						GP22	GP50	GP54	AC22	AC3	AC50
L43 8PA75 EXT	22154	8	3/4	1/2	4.80						
L53 8PA75 EXT	22474	8	3/4	5/8	4.80	●					
L43 8PA75 INT	22158	8	3/4	1/2	4.80	●					
L53 8PA75 INT	22478	8	3/4	5/8	4.80	●					

V THREADING - 60° L43 & 53- 1/2" & 5/8" I.C.

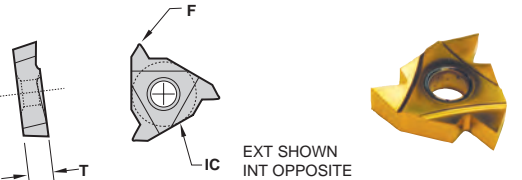

Description	EDP Code	Pitch (mm)	F	IC	T	TIN Coated			A1TIN Coated		
						GP22	GP50	GP54	AC22	AC3	AC50
L43 NV EXT	0115040	0.50-3.0	0.15/0.20	1/2	4.80		●			●	●
L53 NV EXT	0147040	1.00-5.0	0.15/0.20	5/8	4.80		●			●	●
L43 NV INT	0115080	0.50-3.0	0.15/0.20	1/2	4.80		●			●	●
L53 NV INT	0147080	1.00-5.0	0.15/0.20	5/8	4.80		●			●	●

LN 43 - 1/2" I.C. Double Sided

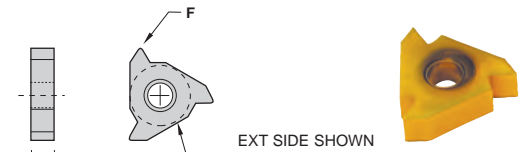

Description	EDP Code	Pitch (mm)	F	IC	T	TIN Coated			A1TIN Coated		
						GP22	GP50	GP54	AC22	AC3	AC50
LN 43 NV	0120000	0.50-3.0	0.15/0.20	1/2	4.80	●					

V THREADING - 60° LPGC 32, 42 & 43 - 3/8" & 1/2" I.C.

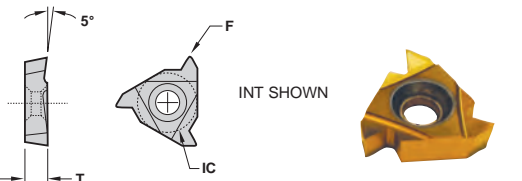

Description	EDP Code	Pitch (mm)	F	IC	T	TIN Coated			A1TIN Coated		
						GP22	GP5	GP54	AC25	AC3	AC50
LPGC 32 NV INT RH	0104R80	0.50-3.0	0.10/0.15	3/8	3.23		●				
LPGC 32 NV INT LH	0104L80	0.50-3.0	0.10/0.15	3/8	3.23		●				
LPGC 42 NV INT RH	0113R80	1.20-3.0	0.15/0.20	1/2	3.23		●		●		
LPGC 42 NV INT LH	0113L80	1.20-3.0	0.15/0.20	1/2	3.23		●		●		
LPGC 43 NV INT RH	0127R80	1.50-5.0	0.15/0.20	1/2	4.80		●		●		
LPGC 43 NV INT LH	0127L80	1.50-5.0	0.15/0.20	1/2	4.80		●		●		

TNPGC 43 - 1/2" I.C. Double Sided

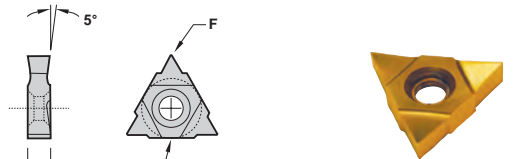

Description	EDP Code	Pitch (mm)	F	IC	T	TIN Coated			A1TIN Coated		
						GP22	GP50	GP54	AC22	AC3	AC50
TNPGC 43 NV	0137000	0.50-3.0	0.13/0.18	1/2	4.80	●					

TPGC 32, 42 & 43 - 3/8" & 1/2" I.C.

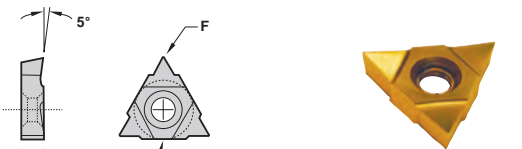

Description	EDP Code	Pitch (mm)	F	IC	T	TIN Coated			A1TIN Coated		
						GP22	GP5	GP54	AC22	AC3	AC50
TPGC 32 NV	0107000	0.50-3.0	0.13/0.18	3/8	3.23		●				
TPGC 42 NV	0114000	1.00-5.0	0.13/0.18	1/2	3.23		●		●		
TPGC 43 NV	0138000	1.50-6.5	0.13/0.18	1/2	4.80		●				

In an effort to improve our stock standard grade offering, there are periodic changes. Please see current price list for up to date grade offering.

- High performance choice in optimal conditions.
- ▲ Recommended grade under general conditions.

Material	GP22	GP5	GP54	AC22	AC3	AC50
Cast Iron						●
Non-Ferrous						●
Stainless/High Temp						●
Steel	▲					

LAYDOWN



EXTERNAL HOLDER

MTENR/L

Threading

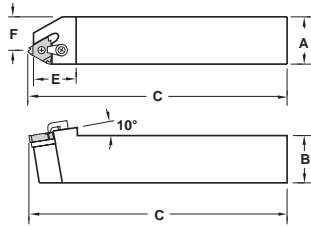

PARTS

Description	EDP Code	Insert	A	B	C	E	F*	PARTS			
								Seat	Lock Pin	Clamp	Clamp Screw
MTENR-2525M4	952025M56	TNPGC 43	25.00	25.00	152.40	37.34	16.00	TS 43*	NLM46	CLM-6	XNSM0515
MTENR-3232M4	952032M56	TNPGC 43	32.00	32.00	177.80	37.34	22.35	TS 43*	NLM46	CLM-6	XNSM0515

*Seats can be ordered as NO FORM or a FORM can be specified. Ex: TS 43 API EXT Seat.

MTVNR/L

Threading & Grooving

Inch

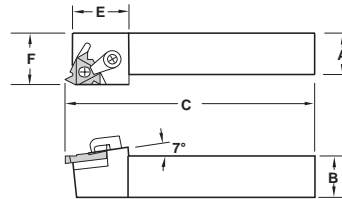

PARTS

Description	EDP Code	Insert	A	B	C	E	F*	PARTS			
								Seat	Lock Pin	Clamp	Clamp Screw
MTVNR-2525M4	9580M2556	L43	25.00	25.00	152.40	32.26	31.75	LS43*	NLM46	CLM-6	XNSM0515
MTVNL-2525M4	9570M2556	L43	25.00	25.00	152.40	32.26	31.75	LS43*	NLM46	CLM-6	XNSM0515
MTVNR-3232M4	9580M3256	L43	32.00	32.00	177.80	32.26	38.10	LS43*	NLM46	CLM-6	XNSM0515
MTVNR-2525M5	9580M2562	L53	25.00	25.00	152.40	38.86	31.75	LS53*	NLM58	CLM-20	STCM11
MTVNL-2525M5	9570M2562	L53	25.00	25.00	152.40	38.86	31.75	LS53*	NLM58	CLM-20	STCM11
MTVNR-3232M5	9580M3262	L53	32.00	32.00	177.80	38.86	38.10	LS53*	NLM58	CLM-20	STCM11
MTVNR-3232M54	9580M3264	LDS 54	32.00	32.00	177.80	38.86	38.10	LS53*	NLM58	CLM-20	STCM11

*Seats can be ordered as NO FORM or a FORM can be specified. Ex: LS 43 API EXT. Seat.

INTERCHANGEABLE

HEADS

H-LNFR/L*

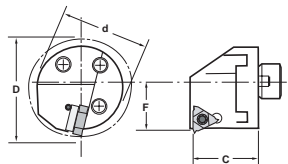

RH SHOWN

PARTS

Description	EDP Code	Insert	d	C	F	Min. Bore (D)	PARTS			
							Seat	Clamp	Clamp Screw	Lock Pin
H32M-LNFR-43	9IH42032M56	L43	32	41.28	19.43	36.83	-	CLM-6	STCM9	NLM44
H40M-LNFR-43	9IH42040M56	L43	40	41.28	22.61	44.70	-	CLM-6	STCM9	NLM44
H50M-LNFR-43	9IH42050M56	L43	50	41.28	32.54	60.96	LS43	CLM-6	XNSM0515	NLM46
H40M-LNFR-53API	9IH44040M62	L53	40	41.28	22.61	44.70	-	CLM-20	STCM11	NLM56
H50M-LNFR-53API	9IH44050M62	L53	50	41.28	32.54	60.96	-	CLM-20	STCM11	NLM56
H40M-LNFR-54API	9IH44040M64	LDS 54	40	41.28	22.61	44.70	-	CLM-20	STCM11	H410-1
H50M-LNFR-54API	9IH44050M64	LDS 54	50	41.28	32.54	60.96	-	CLM-20	STCM11	NLM56

*Non API heads only for 8RD, 10RD, 5B75, 5B1 threads. API heads required for rotary shoulder connections threads.

HS-LNFR/L*

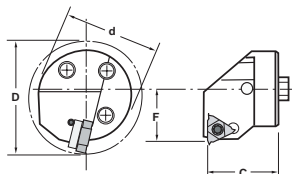

RH SHOWN

PARTS

Description	EDP Code	Insert	d	C	F	Min. Bore (D)	PARTS		
							Clamp	Clamp Screw	Lock Pin
HS32-LNFR-43	9IHS42032M56	L43	32.00	32.00	22.00	39.88	CLM-6	STCM9	NLM44
HS40-LNFR-43	9IHS42040M56	L43	40.00	32.00	27.00	50.04	CLM-6	STCM9	NLM44
HS50-LNFR-43	9IHS42050M56	L43	50.00	39.88	35.00	62.99	CLM-6	STCM9	NLM44
HS40-LNFR-53API	9IHS4440M62	L53	40.00	32.00	27.00	50.04	CLM-20	STCM11	NLM56
HS50-LNFR-53API	9IHS4450M62	L53	50.00	39.88	35.00	62.99	CLM-20	STCM11	NLM56
HS40-LNFR-54API	9IHS4440M64	LDS 54	40.00	32.00	27.00	50.04	CLM-20	STCM11	H410-1
HS50-LNFR-54API	9IHS4450M64	LDS 54	50.00	39.88	35.00	62.99	CLM-20	STCM11	NLM56

*Non API heads only for 8RD, 10RD, 5B75, 5B1 threads. API heads required for rotary shoulder connections threads.



LAYDOWN

INTERNAL BAR

LFR/L

Threading & Grooving

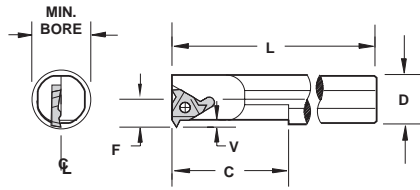

Description	EDP Code	Insert	Min. Bore	L	D	C	F	V	Torx Screw
LFR 16M-32	939016M48	LPGC 32	16.00	200.00	16.00	2-1/2	7.92	2.54	SFM30
LFL 16M-32	938016M48	LPGC 32	16.00	200.00	16.00	2-1/2	7.92	2.54	SFM30
LFR 20M-32	939020M48	LPGC 32	20.00	200.00	20.00	2-3/4	9.53	2.54	SFM30
LFL 20M-32	938020M48	LPGC 32	20.00	200.00	20.00	2-3/4	9.53	2.54	SFM30
LFR 25M-32	939025M48	LPGC 32	25.00	250.00	25.00	2-3/4	12.70	2.54	SFM30
LFL 25M-32	938025M48	LPGC 32	25.00	250.00	25.00	2-3/4	12.70	2.54	SFM40
LFR 20M-42	939020M54	LPGC 42	20.00	200.00	20.00	2-3/4	9.53	2.54	SFM50
LFL 20M-42	938020M54	LPGC 42	20.00	200.00	20.00	2-3/4	9.53	2.54	SFM60
LFR 25M-43	939025M56	LPGC 43	25.00	250.00	25.00	2-3/4	12.70	3.18	SFM60
LFL 25M-43	938025M56	LPGC 43	25.00	250.00	25.00	2-3/4	12.70	3.18	SFM60
LFR 32M-43	939032M56	LPGC 43	32.00	300.00	32.00	2-3/4	15.88	3.18	SFM60
LFL 32M-43	938032M56	LPGC 43	32.00	300.00	32.00	2-3/4	15.88	3.18	SFM60
LFR 40M-43	939040M56	LPGC 43	40.00	350.00	40.00	3-3/4	19.05	3.18	SFM60
LFL 40M-43	938040M56	LPGC 43	40.00	350.00	40.00	3-3/4	19.05	3.18	SFM60
LFR 50M-43	939050M56	LPGC 43	50.00	350.00	50.00	3-3/4	25.40	3.18	SFM60
LFL 50M-43	938050M56	LPGC 43	50.00	350.00	50.00	3-3/4	25.40	3.18	SFM60
LFR 40M-53	939040M62	LPGC 53	40.00	350.00	40.00	3-3/4	19.05	3.81	SFM67
LFL 40M-53	938040M62	LPGC 53	40.00	350.00	40.00	3-3/4	19.05	3.81	SFM67
LFR 50M-53	939050M62	LPGC 53	50.00	350.00	50.00	3-3/4	25.40	3.81	SFM85

*Over NV Insert

LAYDOWN

LNFR/L

Threading & Grooving

Inch

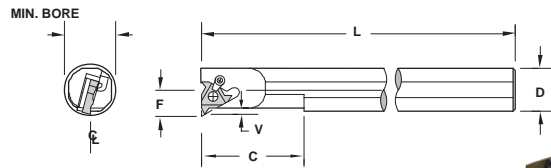

PARTS

Description	EDP Code	Insert	Min. Bore	L	D	C	F	V*	Screw/ Seat	Lock Pin	Clamp Clamp	Screw
LNFR 32M-43	942M3256	L43	35,0	304,8	32,0	69,5	17,5	3,2	-	NLM44	CLM6	XNSM0515
LNFL 32M-43	941M3256	L43	35,0	304,8	32,0	69,5	17,5	3,2	-	NLM44	CLM6	XNSM0515
LNFR 40M-43	942M4056	L43	43,2	355,6	40,0	95,2	21,6	3,2	-	NLM44	CLM6	STCM9
LNFL 40M-43	941M4056	L43	43,2	355,6	40,0	95,2	21,6	3,2	-	NLM44	CLM6	STCM9
LNFR 50M-43	942M5056	L43	54,1	355,6	50,0	101,6	27,0	3,2	LS43*	NLM46	CLM6	XNSM0515
LNFL 50M-43	941M5056	L43	54,1	355,6	50,0	101,6	27,0	3,2	LS43*	NLM46	CLM6	XNSM0515
LNFR 40M-53	942M4062	L53	44,1	355,6	40,0	101,6	22,0	3,8	-	NLM56	CLM20	STCM11
LNFL 40M-53	941M4062	L53	44,1	355,6	40,0	101,6	22,0	3,8	-	NLM56	CLM20	STCM11
LNFR 50M-53	942M5062	L53	54,1	355,6	50,0	101,6	27,4	3,8	LS53*	NLM58	CLM20	STCM11
LNFL 50M-53	941M5062	L53	54,1	355,6	50,0	101,6	27,4	3,8	LS53*	NLM58	CLM20	STCM11
LNFR 40M-54	942M4064	LDS54	44,1	355,6	40,0	101,6	22,0	3,8	-	NLM56	CLM20	STCM11
LNFL 40M-54	941M4064	LDS54	44,1	355,6	40,0	101,6	22,0	3,8	-	NLM56	CLM20	STCM11
LNFR 50M-54	942M5064	LDS54	54,1	355,6	50,0	101,6	27,4	3,8	-	NLM56	CLM20	STCM11
LNFL 50M-54	941M5064	LDS54	54,1	355,6	50,0	101,6	27,4	3,8	-	NLM56	CLM20	STCM11

*Seat can be ordered as NO FORM or a FORM can be specified. EX: LS 43 API INT SEAT ** Over Sharp

**Non API bars will work for 8/10RD and 5B75/5B1 threadforms. API bars required for rotary shoulder connection threadforms.



INTERNAL BAR

LNFR/L-API

Threading

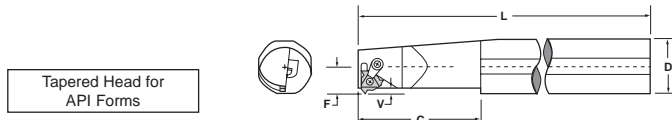

PARTS

Description	EDP Code	Insert	Min. Bore	L	D	C	F	Lock V*	Pin	Clamp	Clamp Screw
LNFR 40M-43API	944M4056	L43	41,9	355,6	40,0	114,3	20,9	4,2	NLM44	CLM6	XNSM0515
LNFR 50M-43API	944M5056	L43	55,0	355,6	50,0	114,3	27,4	4,2	NLM44	CLM6	XNSM0515
LNFR 40M-53API	944M4062	L53	42,1	355,6	40,0	114,3	20,9	5,8	NLM56	CLM20	STCM11
LNFR 50M-53API	944M5062	L53	55,2	406,4	50,0	114,3	27,6	5,8	NLM56	CLM20	STCM11
LNFR 50M-54API	944M5064	LDS 54	55,2	406,4	50,0	114,3	27,6	5,8	NLM56	CLM20	STCM11

*Seat can be ordered as NO FORM or a FORM can be specified. EX: LS 43 API INT SEAT if required.

**Required for rotary shoulder connection threading inserts.

LNTR/L

Threading

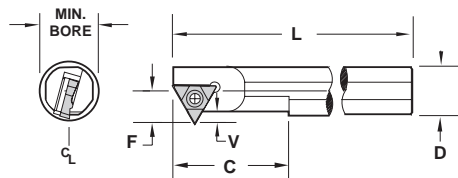

Description	EDP Code	Insert	Min. Bore	L	D	C	F*	V	Torx Screw
LNTR 22M-43	947022M56	TNPGC 43	22.35	200.00	25.00	69.85	11.18	5.05	SFM60
LNTL 22M-43	946022M56	TNPGC 43	22.35	200.00	25.00	69.85	11.18	5.05	SFM60
LNTR 25M-43	947025M56	TNPGC 43	25.00	250.00	25.00	69.85	12.45	5.41	SFM60
LNTL 25M-43	946025M56	TNPGC 43	25.00	250.00	25.00	69.85	12.45	5.41	SFM60
LNTR 32M-43	947032M56	TNPGC 43	32.00	300.00	32.00	69.85	16.26	5.41	SFM60
LNTL 32M-43	946032M56	TNPGC 43	32.00	300.00	32.00	69.85	16.26	5.41	SFM60
LNTR 40M-43	947040M56	TNPGC 43	40.00	350.00	40.00	95.25	18.80	5.41	SFM60
LNTL 40M-43	946040M56	TNPGC 43	40.00	350.00	40.00	95.25	18.80	5.41	SFM60
LNTR 50M-43	947050M56	TNPGC 43	50.00	350.00	50.00	95.25	25.15	5.41	SFM60
LNTL 50M-43	946050M56	TNPGC 43	50.00	350.00	50.00	95.25	25.15	5.41	SFM60

*Over NV Insert

LTR/L

Threading & Grooving

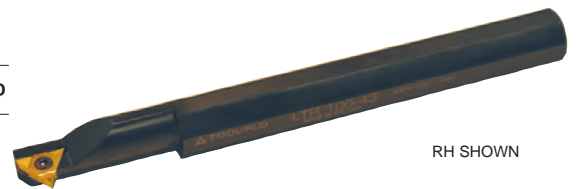
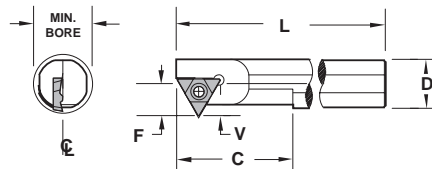

Description	EDP Code	Insert	Min. Bore	L	D	C	F	V*	Torx Screw
LTR 16M-32	950016M48	TPGC 32	16.00	200.00	16.00	63.50	9.53	3.81	SFM30
LTL 16M-32	949016M48	TPGC 32	16.00	200.00	16.00	63.50	9.53	3.81	SFM30
LTR 20M-32	950020M48	TPGC 32	20.00	200.00	20.00	69.85	9.53	3.81	SFM30
LTL 20M-32	949020M48	TPGC 32	20.00	200.00	20.00	69.85	9.53	3.81	SFM30
LTR 25M-32	950025M48	TPGC 32	25.40	250.00	25.00	69.85	12.70	3.81	SFM30
LTL 25M-32	949025M48	TPGC 32	25.40	250.00	25.00	69.85	12.70	3.81	SFM30
LTR 20M-42	950020M54	TPGC 42	20.32**	200.00	20.00	69.85	9.91	3.18	SFM50
LTL 20M-42	949020M54	TPGC 42	20.32**	200.00	20.00	69.85	9.91	3.18	SFM50
LTR 25M-43	950025M56	TPGC 43	25.00	250.00	25.00	69.85	12.70	5.41	SFM60
LTL 25M-43	949025M56	TPGC 43	25.00	250.00	25.00	69.85	12.70	5.41	SFM60
LTR 32M-43	950032M56	TPGC 43	32.00	300.00	32.00	69.85	15.88	5.41	SFM60
LTL 32M-43	949032M56	TPGC 43	32.00	300.00	32.00	69.85	15.88	5.41	SFM60
LTR 40M-43	950040M56	TPGC 43	40.00	350.00	40.00	95.25	19.05	5.41	SFM60
LTL 40M-43	949040M56	TPGC 43	40.00	350.00	40.00	95.25	19.05	5.41	SFM60
LTR 50M-43	950050M56	TPGC 43	50.00	350.00	50.00	95.25	25.40	5.41	SFM60
LTL 50M-43	949050M56	TPGC 43	50.00	350.00	50.00	95.25	25.40	5.41	SFM60
LTR 40M-53	950040M62	TPGC 53	40.00	350.00	40.00	95.25	19.05	7.62	SFM85
LTL 40M-53	949040M62	TPGC 53	40.00	350.00	40.00	95.25	19.05	7.62	SFM85
LTR 50M-53	950050M62	TPGC 53	50.00	350.00	50.00	95.25	25.40	7.62	SFM85
LTL 50M-53	949050M62	TPGC 53	50.00	350.00	50.00	95.25	25.40	7.62	SFM85

*Over NV Insert

**Over 4P Acme Insert

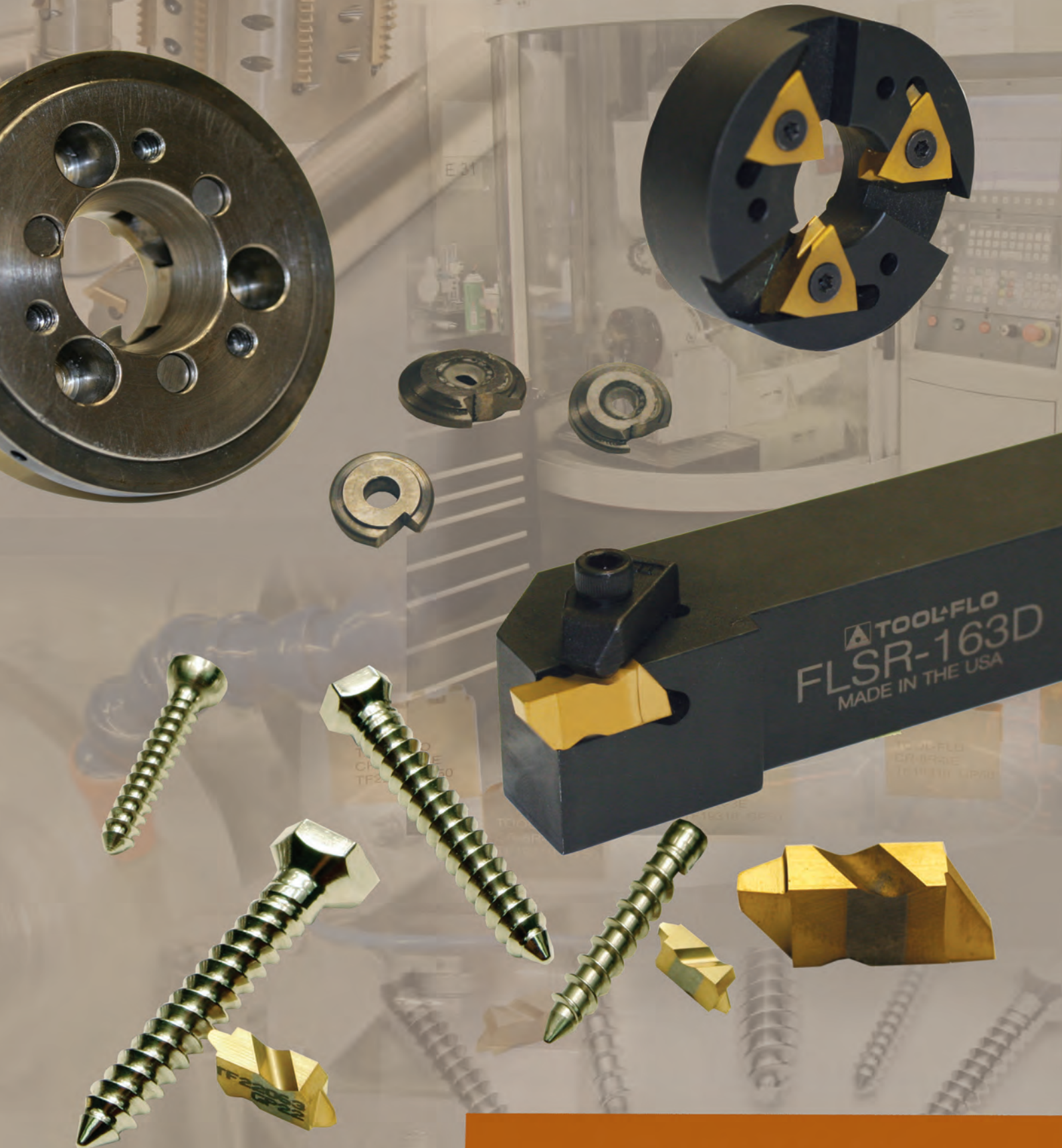

MEDICAL

Manufacturing custom threading inserts and special holders for the medical field for over

35 Years!

All insert styles: whirling inserts
triangle
Flo-Lock (for standard lathe operations)



Grades for Titanium (6AL4V)
stainless steel!

Special Quotes:

(800) 345-2815 or
rfq@toolflo.com



Custom threadforms designed
to your needs.

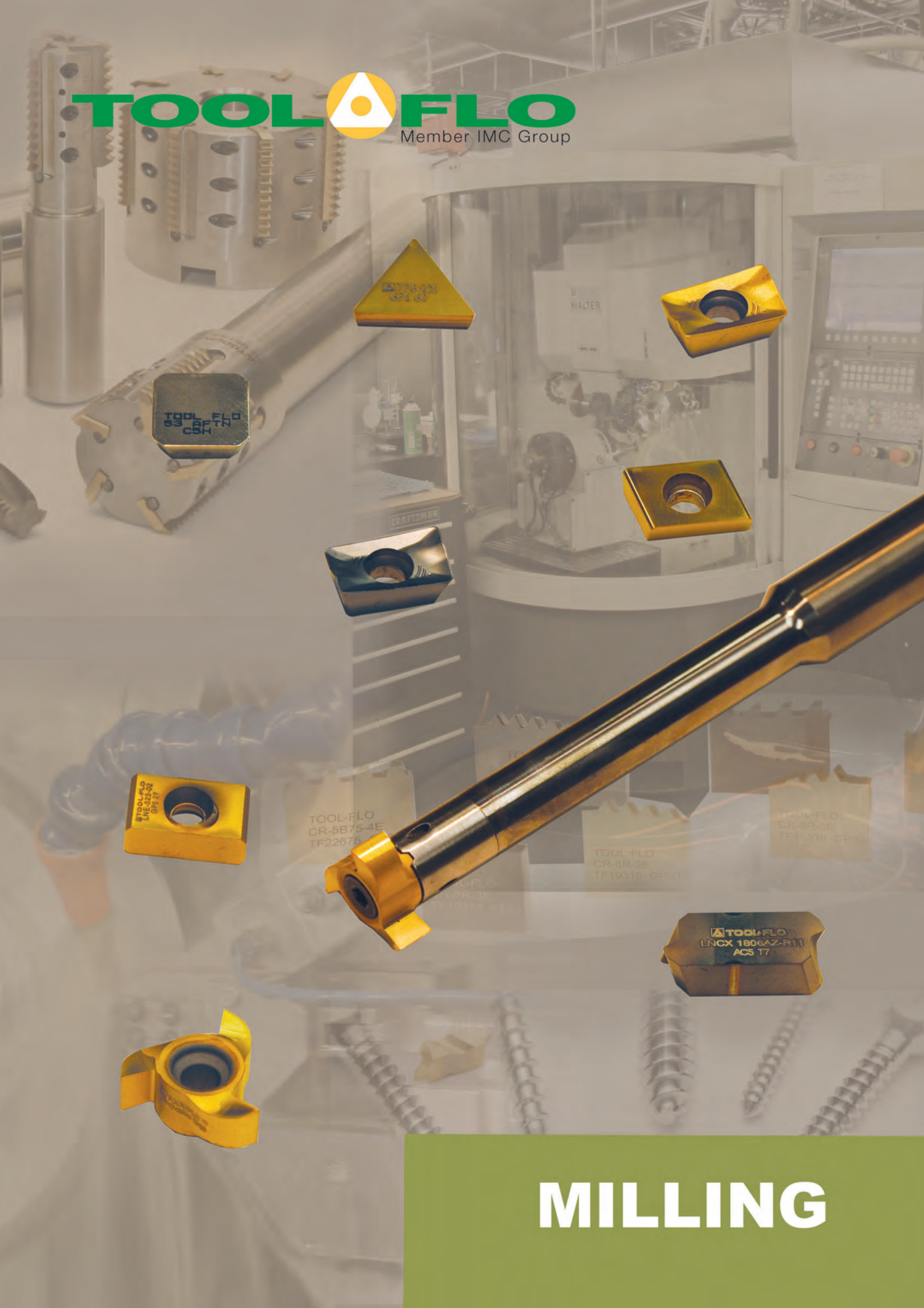

MILLING



MILLING INSERTS

APKT

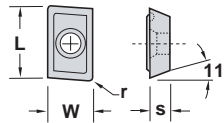

Description	EDP Code	L	W	s	r	GP201	AC202	AG6M	P56M	G55M	P5M	GP5	AC5
APKT 1003PDER-SCM	MAPKT1003SCM	10.49	6.68	3.48	0.48	●	●		●		●		

LNCX

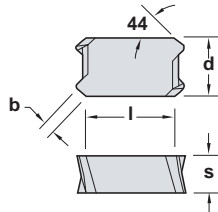

Description	EDP Code	l	d	s	b	GP201	AC202	AG6M	P56M	G55M	P5M	GP5	AC5
LNCX 1806AZ-L11	MLNCXL	18.77	10.01	6.35	2.16							●	●
LNCX 1806AZ-R11	MLNCXR	18.77	10.01	6.35	2.16							●	●

SEKN

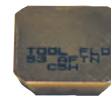
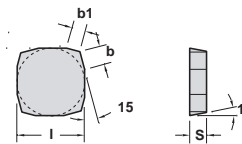

Description	EDP Code	l	s	b	b1	AG450	A460	AG501	P56M	G55M	P5M	GP5	AT5
SEKN 42AFSN	MSEKN425N	12.70	3.18	-	-							●	
SEKN 42AFSN-11	MSEKN425N11	12.70	3.18	-	-							●	
SEKN 42AFSN-HCM	MSEKN425NHCM	12.70	3.18	-	-							●	
SEKN 42AFSN-SCM	MSEKN425NSCM	12.70	3.18	-	-							●	
SEKN 53AFSN	MSEKN535N	15.88	4.78	-	-							●	
SEKN 53AFSN-11	MSEKN535N11	15.88	4.78	-	-							●	

SPG

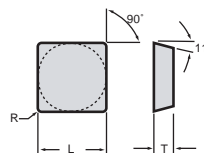

Description	EDP Code	L	L	T	r	GP201	AT202	AG6M	P56M	G55M	P5M	GP5	AT5
SPG 422	MSG422	12.70	12.70	3.18	0.79							●	
SPG 423	MSG423	12.70	12.70	3.18	1.19							●	
SPG 633	MSG633	19.05	19.05	4.75	1.19							●	
SPG 634	MSG634	19.05	19.05	4.75	1.57							●	

TPG

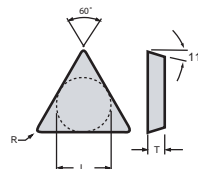

Description	EDP Code	l	T	R	C3	C56	AG6M	P56M	G55M	P5M	GP5	AT5
TPG 321	MTG321	15.75	3.18	0.38		●					●	
TPG 322	MTG322	15.75	3.18	0.79	●	●					●	
TPG 431	MTG431	22.00	4.75	0.38		●					●	
TPG 432	MTG432	22.00	4.75	0.79							●	
TPG 433	MTG433	22.00	4.75	1.19							●	



MILLING

GROOVE MILLING INSERT

TFMG

Grooving

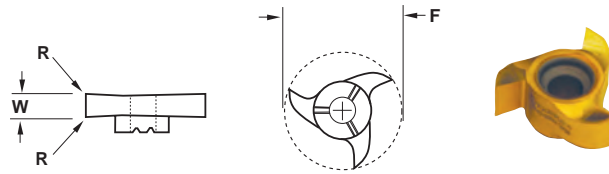

Description	EDP Code	W	D.O.C.	R	F	GP22
TFMG-039W	9MG039O3	0.99	4.50	-	21.69	●
TFMG-056W	9MG056O3	1.42	4.50	-	21.69	●
TFMG-062W	9MG062O3	1.57	4.50	0.20	21.69	●
TFMG-078W	9MG078O3	1.98	4.50	0.20	21.69	●
TFMG-094W	9MG094O3	2.39	4.50	0.20	21.69	●
TFMG-125W	9MG125O3	3.18	4.50	0.20	21.69	●
TFMG-187W	9MG187O3	4.75	4.50	0.20	21.69	●
TFMG-250W	9MG250O3	6.35	4.50	0.20	21.69	●

GROOVE MILLING HOLDER

TFM

Carbide Shank

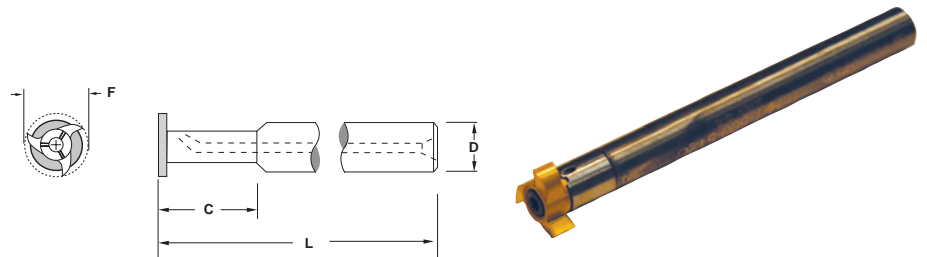

Description	EDP Code	C	L	D	F	Insert Screw
TFM-7-12M-100C	9CMI712M100	Straight shank	100mm	12mm	21.69	SDM25
TFM-7-12M-130C	9CMI712M130	Straight shank	130mm	12mm	21.69	SDM25
TFM-7-16M-42C	9CMI716M42	42mm	100mm	16mm	21.69	SDM25
TFM-7-16M-60C	9CMI716M60	60mm	130mm	16mm	21.69	SDM25
TFM-7-16M-85C	9CMI716M85	85mm	160mm	16mm	21.69	SDM25
TFM-7-500-394C	9CMI7500394	Straight shank	100.08	12.70	21.69	SDM25
TFM-7-500-512C	9CMI7500512	Straight shank	130.05	12.70	21.69	SDM25
TFM-7-625-165C	9CMI7625165	41.91	100.08	15.88	21.69	SDM25
TFM-7-625-236C	9CMI7625236	66.80	130.05	15.88	21.69	SDM25
TFM-7-625-335C	9CMI7625335	85.09	160.02	15.88	21.69	SDM25

MILLING



Mill Grooving - TFMG



Workpiece Group	Recommended Speed & Feed rate - inch/rev (mm/rev)	
	Cutting Speed (m/min)	Feed Rate (m/t)
Free Machining Carbon Steels	182.88 - 213.36	0.25 - 0.41
Plain Carbon Steels	182.88 - 213.36	0.25 - 0.41
Alloy Steels 190-330 HB	106.68 - 137.16	0.25 - 0.41
Alloy Steels 330-450 HB	106.68 - 137.16	0.25 - 0.41
Martensitic/Ferritic Stainless Steel 400 Series	60.96 - 121.92	0.25 - 0.41
Austenitic Stainless 300 Series	106.68 - 167.64	0.25 - 0.41
Gray Cast Iron 190-330 HB	91.44 - 106.68	0.30 - 0.51
Gray Cast Iron 330-450 HB	91.44	0.30 - 0.51
Alloy / Ductile Irons	60.96 - 91.44	0.30 - 0.51
Free Machining Aluminum Alloys	152.40 - 701.04	0.30 - 0.51
High-Silicon Aluminum Alloys	137.16 - 274.32	0.30 - 0.51
Copper / Zinc / Brass	36.58 - 137.16	0.30 - 0.51
Non-Metallics	36.58 - 91.44	0.30 - 0.51
High Temperature Alloys 200-260 HB	30.48 - 76.20	0.10 - 0.25
High Temperature Alloys 260-450 HB	24.38 - 39.62	0.08 - 0.20
Titanium Alloys (Ti 6Al-4V)	24.38 - 39.62	0.08 - 0.20
Hardened Materials 48-65 HRC	---	---

Rigid ▶ Very Rigid*

* For not rigid set ups start at .0127 m/t





TOOL-FLO
CR-5B75-4E
TF22675 G50

TOOL-FLO
CR-5B75-4E
TF22675 G50

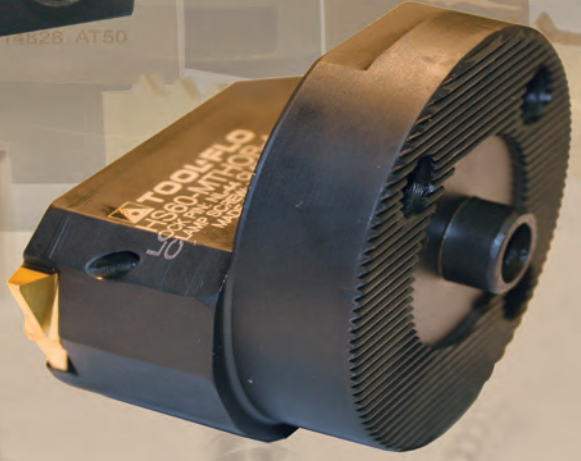

ON EDGE



ACME TNMA Straight hole

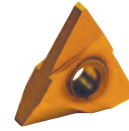
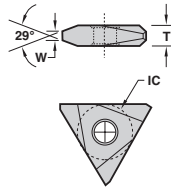

Description	EDP Code	TPI	W	IC	T	Uncoated		TIN Coated		AlTiN Coated	
						C3	C6H	GP3	GP50	AC3	AC50
TNMA 32 NT 6P	0208060	6	1.44	3/8 (9.52)	3.23	●	●	●	●	●	●
TNMA 32 NT 8P	0208080	8	1.04	3/8 (9.52)	3.23	●	●	●	●	●	●
TNMA 32 NT 10P	0208100	10	0.81	3/8 (9.52)	3.23			●	●	●	●
TNMA 32 NT 12P	0208120	12	0.72	3/8 (9.52)	3.23			●	●	●	●
TNMA 32 NT 14P	0208140	14	0.61	3/8 (9.52)	3.23			●	●	●	●
TNMA 32 NT 16P	0208160	16	0.52	3/8 (9.52)	3.23			●	●	●	●
TNMA 43 NT 4P	0239040	4	2.22	1/2 (12.7)	4.80			●	●	●	●
TNMA 43 NT 5P	0239050	5	1.75	1/2 (12.7)	4.80			●	●	●	●
TNMA 43 NT 6P	0239060	6	1.44	1/2 (12.7)	4.80			●	●	●	●
TNMA 43 NT 8P	0239080	8	1.04	1/2 (12.7)	4.80			●	●	●	●
TNMA 43 NT 10P	0239100	10	0.81	1/2 (12.7)	4.80			●	●	●	●
TNMA 43 NT 12P	0239120	12	0.72	1/2 (12.7)	4.80			●	●	●	●
TNMA 43 NT 14P	0239140	14	0.61	1/2 (12.7)	4.80			●	●	●	●
TNMA 43 NT 16P	0239160	16	0.52	1/2 (12.7)	4.80			●	●	●	●
TNMA 54 NT 3P	0251030	3	3.01	5/8 (15.88)	6.40			●	●	●	●
TNMA 54 NT 4P	0251040	4	2.22	5/8 (15.88)	6.40			●	●	●	●
TNMA 54 NT 5P	0251050	5	1.75	5/8 (15.88)	6.40			●	●	●	●
TNMA 55 NT 2.5P	02550250	2.5	3.63	5/8 (15.88)	7.92			●	●	●	●
TNMA 66 NT 2P	0279020	2	4.58	3/4 (19.05)	9.53			●	●	●	●

*Acme threads provided with sharp corners - radius available on a quotation basis.

TNMC Countersink hole

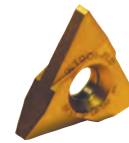
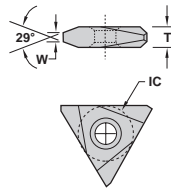

Description	EDP Code	TPI	W	IC	T	Uncoated		TIN Coated		AlTiN Coated	
						C3	C6H	GP3	GP50	AC3	AC50
TNMC 32 NT 6P	0209060	6	1.44	3/8 (9.52)	3.23			●	●	●	●
TNMC 32 NT 8P	0209080	8	1.04	3/8 (9.52)	3.23			●	●	●	●
TNMC 32 NT 10P	0209100	10	0.81	3/8 (9.52)	3.23			●	●	●	●
TNMC 32 NT 12P	0209120	12	0.72	3/8 (9.52)	3.23			●	●	●	●
TNMC 32 NT 14P	0209140	14	0.61	3/8 (9.52)	3.23			●	●	●	●
TNMC 32 NT 16P	0209160	16	0.52	3/8 (9.52)	3.23			●	●	●	●
TNMC 43 NT 4P	0241040	4	2.22	1/2 (12.7)	4.80			●	●	●	●
TNMC 43 NT 5P	0241050	5	1.75	1/2 (12.7)	4.80			●	●	●	●
TNMC 43 NT 6P	0241060	6	1.44	1/2 (12.7)	4.80			●	●	●	●
TNMC 43 NT 8P	0241080	8	1.04	1/2 (12.7)	4.80			●	●	●	●
TNMC 43 NT 10P	0241100	10	0.81	1/2 (12.7)	4.80			●	●	●	●
TNMC 43 NT 12P	0241120	12	0.72	1/2 (12.7)	4.80			●	●	●	●
TNMC 43 NT 14P	0241140	14	0.61	1/2 (12.7)	4.80			●	●	●	●
TNMC 43 NT 16P	0241160	16	0.52	1/2 (12.7)	4.80			●	●	●	●
TNMC 54 NT 3P	0253030	3	3.01	5/8 (15.88)	6.40			●	●	●	●
TNMC 54 NT 4P	0253040	4	2.22	5/8 (15.88)	6.40			●	●	●	●
TNMC 54 NT 5P	0253050	5	1.75	5/8 (15.88)	6.40			●	●	●	●
TNMC 55 NT 2.5P	02560250	2.5	3.63	5/8 (15.88)	7.92			●	●	●	●
TNMC 66 NT 2P	0280020	2	4.58	3/4 (19.05)	9.53		●	●	●	●	●

ON-EDGE

TPMA Straight hole - Positive Rake

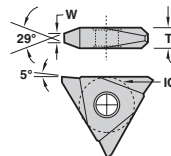

Description	EDP Code	TPI	W	IC	T	Uncoated		TIN Coated		AlTiN Coated	
						C3	C6H	GP3	GP50	AC3	AC50
TPMA 32 NT 6P	0210060	6	1.44	3/8 (9.52)	3.23					●	●
TPMA 32 NT 8P	0210080	8	1.04	3/8 (9.52)	3.23					●	●
TPMA 32 NT 10P	0210100	10	0.81	3/8 (9.52)	3.23					●	●
TPMA 32 NT 12P	0210120	12	0.72	3/8 (9.52)	3.23					●	●
TPMA 43 NT 4P	0240040	4	2.22	1/2 (12.7)	4.80					●	●
TPMA 43 NT 5P	0240050	5	1.75	1/2 (12.7)	4.80					●	●
TPMA 43 NT 6P	0240060	6	1.44	1/2 (12.7)	4.80					●	●
TPMA 43 NT 8P	0240080	8	1.04	1/2 (12.7)	4.80					●	●

*Acme threads provided with sharp corners, radius available on a quotation basis.

#For number of passes see acme table, page

In an effort to improve our stock standard grade offering, there are periodic changes. Please see current price list for up to date grade offering.

- High performance choice in optimal conditions.
- ▲ Recommended grade under general conditions.

Cast Iron											●
Non-Ferrous											●
Stainless/High Temp											●
Steel									▲		●



ACME TPMC

Countersink hole - Positive Rake

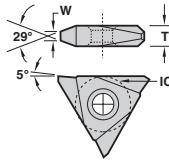

Description	EDP Code	TPI	W	IC	T	Coating							
						C3	C6H	GP3	GP50	AC3	AC50		
TPMC 32 NT 6P	0211060	6	1.44	3/8 (9.52)	3.23								
TPMC 32 NT 8P	0211080	8	1.04	3/8 (9.52)	3.23								
TPMC 32 NT 10P	0211100	10	0.81	3/8 (9.52)	3.23								
TPMC 32 NT 12P	0211120	12	0.72	3/8 (9.52)	3.23								
TPMC 43 NT 4P	0242040	4	2.22	1/2 (12.7)	4.80								
TPMC 43 NT 5P	0242050	5	1.75	1/2 (12.7)	4.80								
TPMC 43 NT 6P	0242060	6	1.44	1/2 (12.7)	4.80								
TPMC 43 NT 8P	0242080	8	1.04	1/2 (12.7)	4.80								

ACME - STUB TNMA

Straight hole

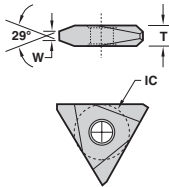

Description	EDP Code	TPI	W	IC	T	Coating							
						C3	C6H	GP3	GP50	AC3	AC50		
TNMA 32 NT 6P STUB	0208061	6	1.66	3/8 (9.52)	3.23								
TNMA 32 NT 8P STUB	0208081	8	1.21	3/8 (9.52)	3.23								
TNMA 32 NT 10P STUB	0208101	10	0.94	3/8 (9.52)	3.23								
TNMA 32 NT 12P STUB	0208121	12	0.83	3/8 (9.52)	3.23								
TNMA 32 NT 14P STUB	0208141	14	0.70	3/8 (9.52)	3.23								
TNMA 32 NT 16P STUB	0208161	16	0.60	3/8 (9.52)	3.23								
TNMA 43 NT 4P STUB	0239041	4	2.55	1/2 (12.7)	4.80								
TNMA 43 NT 5P STUB	0239051	5	2.01	1/2 (12.7)	4.80								
TNMA 43 NT 6P STUB	0239061	6	1.66	1/2 (12.7)	4.80								
TNMA 43 NT 8P STUB	0239081	8	1.21	1/2 (12.7)	4.80								
TNMA 43 NT 10P STUB	0239101	10	0.94	1/2 (12.7)	4.80								
TNMA 43 NT 12P STUB	0239121	12	0.83	1/2 (12.7)	4.80								
TNMA 43 NT 14P STUB	0239141	14	0.70	1/2 (12.7)	4.80								
TNMA 43 NT 16P STUB	0239161	16	0.60	1/2 (12.7)	4.80								
TNMA 54 NT 3P STUB	0251031	3	3.44	5/8 (15.88)	6.40								
TNMA 54 NT 4P STUB	0251041	4	2.55	5/8 (15.88)	6.40								
TNMA 54 NT 5P STUB	0251051	5	2.01	5/8 (15.88)	6.40								
TNMA 55 NT 2.5P STUB	02550251	2.5	4.16	5/8 (15.88)	7.92								
TNMA 66 NT 2P STUB	0279021	2	5.23	3/4 (19.05)	9.53								

TNMC

Countersink hole

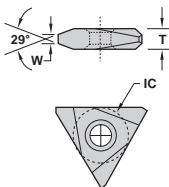

Description	EDP Code	TPI	W	IC	T	Coating							
						C3	C6H	GP3	GP50	AC3	AC50		
TNMC 32 NT 6P STUB	0209061	6	1.66	3/8 (9.52)	3.23								
TNMC 32 NT 8P STUB	0209081	8	1.21	3/8 (9.52)	3.23								
TNMC 32 NT 10P STUB	0209101	10	0.94	3/8 (9.52)	3.23								
TNMC 32 NT 12P STUB	0209121	12	0.83	3/8 (9.52)	3.23								
TNMC 32 NT 14P STUB	0209141	14	0.70	3/8 (9.52)	3.23								
TNMC 32 NT 16P STUB	0209161	16	0.60	3/8 (9.52)	3.23								
TNMC 43 NT 4P STUB	0241041	4	2.55	1/2 (12.7)	4.80								
TNMC 43 NT 5P STUB	0241051	5	2.01	1/2 (12.7)	4.80								
TNMC 43 NT 6P STUB	0241061	6	1.66	1/2 (12.7)	4.80								
TNMC 43 NT 8P STUB	0241081	8	1.21	1/2 (12.7)	4.80								
TNMC 43 NT 10P STUB	0241101	10	0.94	1/2 (12.7)	4.80								
TNMC 43 NT 12P STUB	0241121	12	0.83	1/2 (12.7)	4.80								
TNMC 43 NT 14P STUB	0241141	14	0.70	1/2 (12.7)	4.80								
TNMC 43 NT 16P STUB	0241161	16	0.60	1/2 (12.7)	4.80								
TNMC 54 NT 3P STUB	0253031	3	3.44	5/8 (15.88)	6.40								
TNMC 54 NT 4P STUB	0253041	4	2.55	5/8 (15.88)	6.40								
TNMC 54 NT 5P STUB	0253051	5	2.01	5/8 (15.88)	6.40								
TNMC 66 NT 2P STUB	0280021	2	5.23	3/4 (19.05)	9.53								

#For number of passes see acme table, page

In an effort to improve our stock standard grade offering, there are periodic changes. Please see current price list for up to date grade offering.

● High performance choice in optimal conditions.
▲ Recommended grade under general conditions.

Cast Iron													
Non-Ferrous													
Stainless/High Temp													
Steel													





ACME - STUB

TPMA

Straight hole - Positive Rake

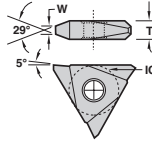

Description	EDP Code	TPI	W	IC	T	Uncoated		TIN Coated		AlTiN Coated	
						C3	C6H	GP3	GP50	AC3	AC50
TPMA 32 NT 6P STUB	0210061	6	1.66	3/8 (9.52)	3.23					●	
TPMA 32 NT 8P STUB	0210081	8	1.21	3/8 (9.52)	3.23					●	
TPMA 32 NT 10P STUB	0210101	10	0.94	3/8 (9.52)	3.23					●	
TPMA 32 NT 12P STUB	0210121	12	0.83	3/8 (9.52)	3.23					●	
TPMA 43 NT 4P STUB	0240041	4	2.55	1/2 (12.7)	4.80					●	
TPMA 43 NT 5P STUB	0240051	5	2.01	1/2 (12.7)	4.80					●	
TPMA 43 NT 6P STUB	0240061	6	1.66	1/2 (12.7)	4.80					●	
TPMA 43 NT 8P STUB	0240081	8	1.21	1/2 (12.7)	4.80					●	

TPMC

Countersink hole - Positive Rake

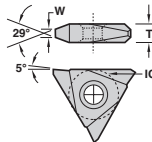

Description	EDP Code	TPI	W	IC	T	C3	C6H	GP3	GP50	AC3	AC50
TPMC 32 NT 6P STUB	0211061	6	1.66	3/8 (9.52)	3.23					●	
TPMC 32 NT 8P STUB	0211081	8	1.21	3/8 (9.52)	3.23					●	
TPMC 32 NT 10P STUB	0211101	10	0.94	3/8 (9.52)	3.23					●	
TPMC 32 NT 12P STUB	0211121	12	0.83	3/8 (9.52)	3.23					●	
TPMC 43 NT 4P STUB	0242041	4	2.55	1/2 (12.7)	4.80					●	
TPMC 43 NT 5P STUB	0242051	5	2.01	1/2 (12.7)	4.80					●	
TPMC 43 NT 6P STUB	0242061	6	1.66	1/2 (12.7)	4.80					●	
TPMC 43 NT 8P STUB	0242081	8	1.21	1/2 (12.7)	4.80					●	

ON-EDGE

ACME - PARTIAL TOPPING (INTERNAL)

TNMA (with corner radii)

Straight hole

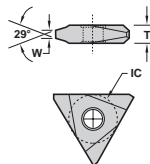

Description	EDP Code	TPI	W	IC	T	C3	C6H	GP3	GP50	AC3	AC50
TNMA 32 NT 6P-PT-I	0208060PTI	6	1.44	3/8 (9.52)	3.23	●				●	●
TNMA 32 NT 8P-PT-I	0208080PTI	8	1.04	3/8 (9.52)	3.23		●			●	●
TNMA 32 NT 10P-PT-I	0208100PTI	10	0.81	3/8 (9.52)	3.23			●		●	●
TNMA 32 NT 12P-PT-I	0208120PTI	12	0.72	3/8 (9.52)	3.23				●	●	●
TNMA 32 NT 14P-PT-I	0208140PTI	14	0.61	3/8 (9.52)	3.23				●	●	●
TNMA 32 NT 16P-PT-I	0208160PTI	16	0.52	3/8 (9.52)	3.23				●	●	●
TNMA 43 NT 4P-PT-I	0239040PTI	4	2.22	1/2 (12.7)	4.80			●		●	●
TNMA 43 NT 5P-PT-I	0239050PTI	5	1.75	1/2 (12.7)	4.80			●		●	●
TNMA 43 NT 6P-PT-I	0239060PTI	6	1.44	1/2 (12.7)	4.80			●		●	●
TNMA 43 NT 8P-PT-I	0239080PTI	8	1.04	1/2 (12.7)	4.80			●		●	●
TNMA 43 NT 10P-PT-I	0239100PTI	10	0.81	1/2 (12.7)	4.80			●		●	●
TNMA 43 NT 12P-PT-I	0239120PTI	12	0.72	1/2 (12.7)	4.80			●		●	●
TNMA 43 NT 14P-PT-I	0239140PTI	14	0.61	1/2 (12.7)	4.80			●		●	●
TNMA 43 NT 16P-PT-I	0239160PTI	16	0.52	1/2 (12.7)	4.80			●		●	●
TNMA 54 NT 3P-PT-I	0251030PTI	3	3.01	5/8 (15.88)	6.40			●		●	●
TNMA 54 NT 4P-PT-I	0251040PTI	4	2.22	5/8 (15.88)	6.40			●		●	●
TNMA 54 NT 5P-PT-I	0251050PTI	5	1.75	5/8 (15.88)	6.40			●		●	●
TNMA 55 NT 2.5P-PT-I	02550250PTI	2.5	3.63	5/8 (15.88)	7.92			●		●	●
TNMA 66 NT 2P-PT-I	0279020PTI	2	4.58	3/4 (19.05)	9.53			●		●	●

*Acme threads provided with sharp corners - radius available on a quotation basis.

#For number of passes see acme table, page.



ACME - PARTIAL TOPPING (INTERNAL)

TNMC (with corner radii)

Countersink hole

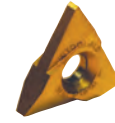
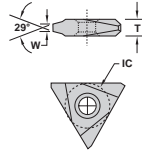

Uncoated		TIN Coated		AlTiN Coated	
C3	C6H	GP3	GP50	AC3	AC50

Description	EDP Code	TPI	W	IC	T	C3	C6H	GP3	GP50	AC3	AC50
TNMC 32 NT 6P-PT-I	0209060PTI	6	1.44	3/8 (9.52)	3.23			●	●	●	●
TNMC 32 NT 8P-PT-I	0209080PTI	8	1.04	3/8 (9.52)	3.23			●	●	●	●
TNMC 32 NT 10P-PT-I	0209100PTI	10	0.81	3/8 (9.52)	3.23			●	●	●	●
TNMC 32 NT 12P-PT-I	0209120PTI	12	0.72	3/8 (9.52)	3.23			●	●	●	●
TNMC 32 NT 14P-PT-I	0209140PTI	14	0.61	3/8 (9.52)	3.23			●	●	●	●
TNMC 32 NT 16P-PT-I	0209160PTI	16	0.52	3/8 (9.52)	3.23			●	●	●	●
TNMC 43 NT 4P-PT-I	0241040PTI	4	2.22	1/2 (12.7)	4.80			●	●	●	●
TNMC 43 NT 5P-PT-I	0241050PTI	5	1.75	1/2 (12.7)	4.80			●	●	●	●
TNMC 43 NT 6P-PT-I	0241060PTI	6	1.44	1/2 (12.7)	4.80			●	●	●	●
TNMC 43 NT 8P-PT-I	0241080PTI	8	1.04	1/2 (12.7)	4.80			●	●	●	●
TNMC 43 NT 10P-PT-I	0241100PTI	10	0.81	1/2 (12.7)	4.80			●	●	●	●
TNMC 43 NT 12P-PT-I	0241120PTI	12	0.72	1/2 (12.7)	4.80			●	●	●	●
TNMC 43 NT 14P-PT-I	0241140PTI	14	0.61	1/2 (12.7)	4.80			●	●	●	●
TNMC 43 NT 16P-PT-I	0241160PTI	16	0.52	1/2 (12.7)	4.80			●	●	●	●
TNMC 54 NT 3P-PT-I	0253030PTI	3	3.01	5/8 (15.88)	6.40			●	●	●	●
TNMC 54 NT 4P-PT-I	0253040PTI	4	2.22	5/8 (15.88)	6.40			●	●	●	●
TNMC 54 NT 5P-PT-I	0253050PTI	5	1.75	5/8 (15.88)	6.40			●	●	●	●
TNMC 55 NT 2.5P-PT-I	02560250PTI	2.5	3.63	5/8 (15.88)	7.92			●	●	●	●
TNMC 66 NT 2P-PT-I	0280020PTI	2	4.58	3/4 (19.05)	9.53			●	●	●	●

ACME - PARTIAL TOPPING (EXTERNAL)

TNMA (with corner radii)

Straight hole

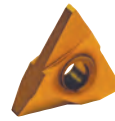
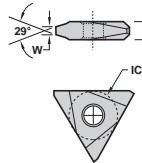

C3	C6H	GP3	GP50	AC3	AC50
----	-----	-----	------	-----	------

Description	EDP Code	TPI	W	IC	T	C3	C6H	GP3	GP50	AC3	AC50
TNMA 32 NT 6P-PT-E	0208060PTE	6	1.44	3/8 (9.52)	3.23	●			●	●	●
TNMA 32 NT 8P-PT-E	0208080PTE	8	1.04	3/8 (9.52)	3.23	●	●		●	●	●
TNMA 32 NT 10P-PT-E	0208100PTE	10	0.81	3/8 (9.52)	3.23			●	●	●	●
TNMA 32 NT 12P-PT-E	0208120PTE	12	0.72	3/8 (9.52)	3.23			●	●	●	●
TNMA 32 NT 14P-PT-E	0208140PTE	14	0.61	3/8 (9.52)	3.23			●	●	●	●
TNMA 32 NT 16P-PT-E	0208160PTE	16	0.52	3/8 (9.52)	3.23			●	●	●	●
TNMA 43 NT 4P-PT-E	0239040PTE	4	2.22	1/2 (12.7)	4.80			●	●	●	●
TNMA 43 NT 5P-PT-E	0239050PTE	5	1.75	1/2 (12.7)	4.80			●	●	●	●
TNMA 43 NT 6P-PT-E	0239060PTE	6	1.44	1/2 (12.7)	4.80			●	●	●	●
TNMA 43 NT 8P-PT-E	0239080PTE	8	1.04	1/2 (12.7)	4.80			●	●	●	●
TNMA 43 NT 10P-PT-E	0239100PTE	10	0.81	1/2 (12.7)	4.80			●	●	●	●
TNMA 43 NT 12P-PT-E	0239120PTE	12	0.72	1/2 (12.7)	4.80			●	●	●	●
TNMA 43 NT 14P-PT-E	0239140PTE	14	0.61	1/2 (12.7)	4.80			●	●	●	●
TNMA 43 NT 16P-PT-E	0239160PTE	16	0.52	1/2 (12.7)	4.80			●	●	●	●
TNMA 54 NT 3P-PT-E	0251030PTE	3	3.01	5/8 (15.88)	6.40			●	●	●	●
TNMA 54 NT 4P-PT-E	0251040PTE	4	2.22	5/8 (15.88)	6.40			●	●	●	●
TNMA 54 NT 5P-PT-E	0251050PTE	5	1.75	5/8 (15.88)	6.40			●	●	●	●
TNMA 55 NT 2.5P-PT-E	02550250PTE	2.5	3.63	5/8 (15.88)	7.92			●	●	●	●
TNMA 66 NT 2P-PT-E	0279020PTE	2	4.58	3/4 (19.05)	9.53			●	●	●	●

*Acme threads provided with sharp corners - radius available on a quotation basis.

TNMC (with corner radii)

Countersink hole

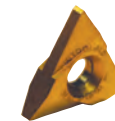
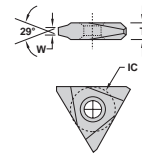

C3	C6H	GP3	GP50	AC3	AC50
----	-----	-----	------	-----	------

Description	EDP Code	TPI	W	IC	T	C3	C6H	GP3	GP50	AC3	AC50
TNMC 32 NT 6P-PT-E	0209060PTE	6	1.44	3/8 (9.52)	3.23			●	●	●	●
TNMC 32 NT 8P-PT-E	0209080PTE	8	1.04	3/8 (9.52)	3.23			●	●	●	●
TNMC 32 NT 10P-PT-E	0209100PTE	10	0.81	3/8 (9.52)	3.23			●	●	●	●
TNMC 32 NT 12P-PT-E	0209120PTE	12	0.72	3/8 (9.52)	3.23			●	●	●	●
TNMC 32 NT 14P-PT-E	0209140PTE	14	0.61	3/8 (9.52)	3.23			●	●	●	●
TNMC 32 NT 16P-PT-E	0209160PTE	16	0.52	3/8 (9.52)	3.23			●	●	●	●
TNMC 43 NT 4P-PT-E	0241040PTE	4	2.22	1/2 (12.7)	4.80			●	●	●	●
TNMC 43 NT 5P-PT-E	0241050PTE	5	1.75	1/2 (12.7)	4.80			●	●	●	●
TNMC 43 NT 6P-PT-E	0241060PTE	6	1.44	1/2 (12.7)	4.80			●	●	●	●
TNMC 43 NT 8P-PT-E	0241080PTE	8	1.04	1/2 (12.7)	4.80			●	●	●	●
TNMC 43 NT 10P-PT-E	0241100PTE	10	0.81	1/2 (12.7)	4.80			●	●	●	●
TNMC 43 NT 12P-PT-E	0241120PTE	12	0.72	1/2 (12.7)	4.80			●	●	●	●
TNMC 43 NT 14P-PT-E	0241140PTE	14	0.61	1/2 (12.7)	4.80			●	●	●	●
TNMC 43 NT 16P-PT-E	0241160PTE	16	0.52	1/2 (12.7)	4.80			●	●	●	●
TNMC 54 NT 3P-PT-E	0253030PTE	3	3.01	5/8 (15.88)	6.40			●	●	●	●
TNMC 54 NT 4P-PT-E	0253040PTE	4	2.22	5/8 (15.88)	6.40			●	●	●	●
TNMC 54 NT 5P-PT-E	0253050PTE	5	1.75	5/8 (15.88)	6.40			●	●	●	●
TNMC 55 NT 2.5P-PT-E	02560250PTE	2.5	3.63	5/8 (15.88)	7.92			●	●	●	●
TNMC 66 NT 2P-PT-E	0280020PTE	2	4.58	3/4 (19.05)	9.53			●	●	●	●

#For number of passes see acme table, page

ON-EDGE



ACME - STUB - PARTIAL TOPPING (INTERNAL)

TNMA (with corner radii)
Straight hole

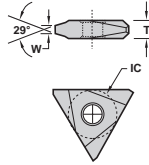

Description	EDP Code	TPI	W	IC	T	Coating					
						C3	C6H	GP3	GP50	AC3	AC50
TNMA 32 NT 6PS-PT-I	0208061PTI	6	1.66	3/8 (9.52)	3.23			●	●	●	●
TNMA 32 NT 8PS-PT-I	0208081PTI	8	1.21	3/8 (9.52)	3.23			●	●	●	●
TNMA 32 NT 10PS-PT-I	0208101PTI	10	0.94	3/8 (9.52)	3.23			●	●	●	●
TNMA 32 NT 12PS-PT-I	0208121PTI	12	0.83	3/8 (9.52)	3.23			●	●	●	●
TNMA 32 NT 14PS-PT-I	0208141PTI	14	0.70	3/8 (9.52)	3.23			●	●	●	●
TNMA 32 NT 16PS-PT-I	0208161PTI	16	0.60	3/8 (9.52)	3.23			●	●	●	●
TNMA 43 NT 4PS-PT-I	0239041PTI	4	2.55	1/2 (12.7)	4.80			●	●	●	●
TNMA 43 NT 5PS-PT-I	0239051PTI	5	2.01	1/2 (12.7)	4.80			●	●	●	●
TNMA 43 NT 6PS-PT-I	0239061PTI	6	1.66	1/2 (12.7)	4.80			●	●	●	●
TNMA 43 NT 8PS-PT-I	0239081PTI	8	1.21	1/2 (12.7)	4.80			●	●	●	●
TNMA 43 NT 10PS-PT-I	0239101PTI	10	0.94	1/2 (12.7)	4.80			●	●	●	●
TNMA 43 NT 12PS-PT-I	0239121PTI	12	0.83	1/2 (12.7)	4.80			●	●	●	●
TNMA 43 NT 14PS-PT-I	0239141PTI	14	0.70	1/2 (12.7)	4.80			●	●	●	●
TNMA 43 NT 16PS-PT-I	0239161PTI	16	0.60	1/2 (12.7)	4.80			●	●	●	●
TNMA 54 NT 3PS-PT-I	0251031PTI	3	3.44	5/8 (15.88)	6.40			●	●	●	●
TNMA 54 NT 4PS-PT-I	0251041PTI	4	2.55	5/8 (15.88)	6.40			●	●	●	●
TNMA 54 NT 5PS-PT-I	0251051PTI	5	2.01	5/8 (15.88)	6.40			●	●	●	●
TNMA 55 NT 2.5PS-PT-I	02550251PTI	2.5	4.16	5/8 (15.88)	7.92			●	●	●	●
TNMA 66 NT 2PS-PT-I	0279021PTI	2	5.23	3/4 (19.05)	9.53			●	●	●	●

TNMC (with corner radii)
Countersink hole

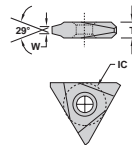

Description	EDP Code	TPI	W	IC	T	Coating					
						C3	C6H	GP3	GP50	AC3	AC50
TNMC 32 NT 6PS-PT-I	0209061PTI	6	1.66	3/8 (9.52)	3.23			●	●	●	●
TNMC 32 NT 8PS-PT-I	0209081PTI	8	1.21	3/8 (9.52)	3.23			●	●	●	●
TNMC 32 NT 10PS-PT-I	0209101PTI	10	0.94	3/8 (9.52)	3.23			●	●	●	●
TNMC 32 NT 12PS-PT-I	0209121PTI	12	0.83	3/8 (9.52)	3.23			●	●	●	●
TNMC 32 NT 14PS-PT-I	0209141PTI	14	0.70	3/8 (9.52)	3.23			●	●	●	●
TNMC 32 NT 16PS-PT-I	0209161PTI	16	0.60	3/8 (9.52)	3.23			●	●	●	●
TNMC 43 NT 4PS-PT-I	0241041PTI	4	2.55	1/2 (12.7)	4.80			●	●	●	●
TNMC 43 NT 5PS-PT-I	0241051PTI	5	2.01	1/2 (12.7)	4.80			●	●	●	●
TNMC 43 NT 6PS-PT-I	0241061PTI	6	1.66	1/2 (12.7)	4.80			●	●	●	●
TNMC 43 NT 8PS-PT-I	0241081PTI	8	1.21	1/2 (12.7)	4.80			●	●	●	●
TNMC 43 NT 10PS-PT-I	0241101PTI	10	0.94	1/2 (12.7)	4.80			●	●	●	●
TNMC 43 NT 12PS-PT-I	0241121PTI	12	0.83	1/2 (12.7)	4.80			●	●	●	●
TNMC 43 NT 14PS-PT-I	0241141PTI	14	0.70	1/2 (12.7)	4.80			●	●	●	●
TNMC 43 NT 16PS-PT-I	0241161PTI	16	0.60	1/2 (12.7)	4.80			●	●	●	●
TNMC 54 NT 3PS-PT-I	0253031PTI	3	3.44	5/8 (15.88)	6.40			●	●	●	●
TNMC 54 NT 4PS-PT-I	0253041PTI	4	2.55	5/8 (15.88)	6.40			●	●	●	●
TNMC 54 NT 5PS-PT-I	0253051PTI	5	2.01	5/8 (15.88)	6.40			●	●	●	●
TNMC 66 NT 2PS-PT-I	0280021PTI	2	5.23	3/4 (19.05)	9.53	●		●	●	●	●

PARTIAL TOPPING STUB ACME - EXTERNAL

TNMA (with corner radii)
Straight hole

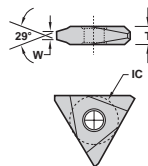

Description	EDP Code	TPI	W	IC	T	Coating					
						C3	C6H	GP3	GP50	AC3	AC50
TNMA 32 NT 6PS-PT-E	0208061PTE	6	1.66	3/8 (9.52)	3.23			●	●	●	●
TNMA 32 NT 8PS-PT-E	0208081PTE	8	1.21	3/8 (9.52)	3.23			●	●	●	●
TNMA 32 NT 10PS-PT-E	0208101PTE	10	0.94	3/8 (9.52)	3.23			●	●	●	●
TNMA 32 NT 12PS-PT-E	0208121PTE	12	0.83	3/8 (9.52)	3.23			●	●	●	●
TNMA 32 NT 14PS-PT-E	0208141PTE	14	0.70	3/8 (9.52)	3.23			●	●	●	●
TNMA 32 NT 16PS-PT-E	0208161PTE	16	0.60	3/8 (9.52)	3.23			●	●	●	●
TNMA 43 NT 4PS-PT-E	0239041PTE	4	2.55	1/2 (12.7)	4.80			●	●	●	●
TNMA 43 NT 5PS-PT-E	0239051PTE	5	2.01	1/2 (12.7)	4.80			●	●	●	●
TNMA 43 NT 6PS-PT-E	0239061PTE	6	1.66	1/2 (12.7)	4.80			●	●	●	●
TNMA 43 NT 8PS-PT-E	0239081PTE	8	1.21	1/2 (12.7)	4.80			●	●	●	●
TNMA 43 NT 10PS-PT-E	0239101PTE	10	0.94	1/2 (12.7)	4.80			●	●	●	●
TNMA 43 NT 12PS-PT-E	0239121PTE	12	0.83	1/2 (12.7)	4.80			●	●	●	●
TNMA 43 NT 14PS-PT-E	0239141PTE	14	0.70	1/2 (12.7)	4.80			●	●	●	●
TNMA 43 NT 16PS-PT-E	0239161PTE	16	0.60	1/2 (12.7)	4.80			●	●	●	●
TNMA 54 NT 3PS-PT-E	0251031PTE	3	3.44	5/8 (15.88)	6.40			●	●	●	●
TNMA 54 NT 4PS-PT-E	0251041PTE	4	2.55	5/8 (15.88)	6.40			●	●	●	●
TNMA 54 NT 5PS-PT-E	0251051PTE	5	2.01	5/8 (15.88)	6.40			●	●	●	●
TNMA 55 NT 2.5PS-PT-E	02550251PTE	2.5	4.16	5/8 (15.88)	7.92			●	●	●	●
TNMA 66 NT 2PS-PT-E	0279021PTE	2	5.23	3/4 (19.05)	9.53			●	●	●	●

#For number of passes see acme table, page



ACME - STUB - PARTIAL TOPPING (EXTERNAL)

TNMC (with corner radii)

Countersink hole

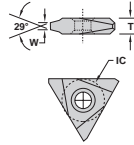

Description	EDP Code	TPI	W	IC	T	Coating					
						C3	C6H	GP3	GP50	AC3	AC50
TNMC 32 NT 6P STUB-PT-E	0209061PTE	6	1.66	3/8 (9.52)	3.23						
TNMC 32 NT 8P STUB-PT-E	0209081PTE	8	1.21	3/8 (9.52)	3.23						
TNMC 32 NT 10P STUB-PT-E	0209101PTE	10	0.94	3/8 (9.52)	3.23						
TNMC 32 NT 12P STUB-PT-E	0209121PTE	12	0.83	3/8 (9.52)	3.23						
TNMC 32 NT 14P STUB-PT-E	0209141PTE	14	0.70	3/8 (9.52)	3.23						
TNMC 32 NT 16P STUB-PT-E	0209161PTE	16	0.60	3/8 (9.52)	3.23						
TNMC 43 NT 4P STUB-PT-E	0241041PTE	4	2.55	1/2 (12.7)	4.80						
TNMC 43 NT 5P STUB-PT-E	0241051PTE	5	2.01	1/2 (12.7)	4.80						
TNMC 43 NT 6P STUB-PT-E	0241061PTE	6	1.66	1/2 (12.7)	4.80						
TNMC 43 NT 8P STUB-PT-E	0241081PTE	8	1.21	1/2 (12.7)	4.80						
TNMC 43 NT 10P STUB-PT-E	0241101PTE	10	0.94	1/2 (12.7)	4.80						
TNMC 43 NT 12P STUB-PT-E	0241121PTE	12	0.83	1/2 (12.7)	4.80						
TNMC 43 NT 14P STUB-PT-E	0241141PTE	14	0.70	1/2 (12.7)	4.80						
TNMC 43 NT 16P STUB-PT-E	0241161PTE	16	0.60	1/2 (12.7)	4.80						
TNMC 54 NT 3P STUB-PT-E	0253031PTE	3	3.44	5/8 (15.88)	6.40						
TNMC 54 NT 4P STUB-PT-E	0253041PTE	4	2.55	5/8 (15.88)	6.40						
TNMC 54 NT 5P STUB-PT-E	0253051PTE	5	2.01	5/8 (15.88)	6.40						
TNMC 66 NT 2P STUB-PT-E	0280021PTE	2	5.23	3/4 (19.05)	9.53						

#For number of passes see acme table, page

AMERICAN STANDARD BUTTRESS

TNMA & TNMC

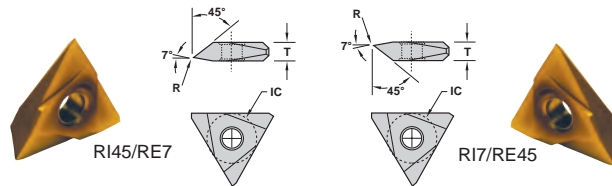

For thread specifications & applications see page 111

Description	EDP Code	TPI	R	IC	T	Lead Angle	Coating					
							C3	C6H	GP3	GP50	AC3	AC50
TNMA 43 ASB RI45/RE7	403900R008	8-16	0.18-0.23	1/2 (12.7)	4.80	45° Internal/7° External						
TNMA 43 ASB RI7/RE45	393900R008	8-16	0.18-0.23	1/2 (12.7)	4.80	7° Internal/45° External						
TNMA 54 ASB RI45/RE7	405100R010	4-6	0.23-0.28	5/8 (15.88)	6.40	45° Internal/7° External						
TNMA 54 ASB RI7/RE45	395100R010	4-6	0.23-0.28	5/8 (15.88)	6.40	7° Internal/45° External						
TNMC 43 ASB RI45/RE7	404100R008	8-16	0.18-0.23	1/2 (12.7)	4.80	45° Internal/7° External						
TNMC 43 ASB RI7/RE45	394100R008	8-16	0.18-0.23	1/2 (12.7)	4.80	7° Internal/45° External						
TNMC 54 ASB RI45/RE7	405300R010	4-6	0.23-0.28	5/8 (15.88)	6.40	45° Internal/7° External						
TNMC 54 ASB RI7/RE45	395300R010	4-6	0.23-0.28	5/8 (15.88)	6.40	7° Internal/45° External						



API BUTTRESS

TNMA

Straight hole

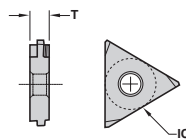

Description	EDP Code	TPI	TPF	IC	T	Conn. No.	Coating					
							C3	C6H	GP3	GP50	AC3	AC50
TNMA 43 8B75 EXT-FC*	21394F	8	.750	1/2 (12.7)	4.80	U.S. Improved Buttress						
TNMA 44 5B75 EXT-FC	16434F	5	.750	1/2 (12.7)	6.40	4-1/2 - 13-3/8						
TNMA 54 5B1 EXT-FC	17514F	5	1.000	5/8 (15.88)	6.40	16 and larger						
TNMA 54 5B75 EXT-FC	16514F	5	.750	5/8 (15.88)	6.40	4-1/2 - 13-3/8						
TNMA 43 8B75 INT-FC	21398F	8	.750	1/2 (12.7)	4.80	U.S. Improved Buttress						
TNMA 44 5B75 INT-FC	16438F	5	.750	1/2 (12.7)	6.40	4-1/2 - 13-3/8						
TNMA 54 5B1 INT-FC	17518F	5	1.000	5/8 (15.88)	6.40	16 and larger						
TNMA 54 5B75 INT-FC	16518F	5	.750	5/8 (15.88)	6.40	4-1/2 - 13-3/8						

*FC designates flank clearance.



API BUTTRESS

TNMC

Countersink hole

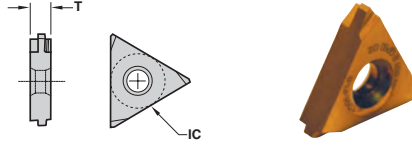

Description	EDP Code	TPI	TPF	IC	T	Conn. No.	Coating						
							C3	C6H	GP3	GP50	AC3	AC50	
TNMC 43 8B75 EXT-FC*	21414F	8	.750	1/2 (12.7)	4.80	U.S. Improved Buttress				●			
TNMC 54 5B1 EXT-FC	17534F	5	1.000	5/8 (15.88)	6.40	16 and larger				●		●	
TNMC 54 5B75 EXT-FC	16534F	5	.750	5/8 (15.88)	6.40	4-1/2 - 13-3/8				●		●	
TNMC 43 8B75 INT-FC	21418F	8	.750	1/2 (12.7)	4.80	U.S. Improved Buttress				●			●
TNMC 54 5B1 INT-FC	17538F	5	1.000	5/8 (15.88)	6.40	16 and larger				●			●
TNMC 54 5B75 INT-FC	16538F	5	.750	5/8 (15.88)	6.40	4-1/2 - 13-3/8				●			●

*FC designates flank clearance.

API HUGHES H90

TNMA

Straight hole

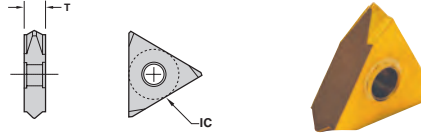

Description	EDP Code	TPI	TPF	IC	T	Conn. No.	Coating						
							C3	C6H	GP3	GP50	AC3	AC50	
TNMA 55 H902 EXT	28554	3.5	2.000	5/8 (15.88)	7.92	3-1/2 - 6-5/8 H90				●			
TNMA 55 H903 EXT	29554	3.5	3.000	5/8 (15.88)	7.92	7 - 8-5/8 H90				●			
TNMA 56 H90S EXT	27Q14	3	1.250	5/8 (15.88)	9.53	2-3/8 - 3-1/2 Slimline				●			
TNMA 55 H902 INT	28558	3.5	2.000	5/8 (15.88)	7.92	3-1/2 - 6-5/8 H90				●			
TNMA 55 H903 INT	29558	3.5	3.000	5/8 (15.88)	7.92	7 - 8-5/8 H90				●			
TNMA 56 H90S INT	27Q18	3	1.250	5/8 (15.88)	9.53	2-3/8 - 3-1/2 Slimline				●			

API HUGHES H90

TNMC

Countersink hole

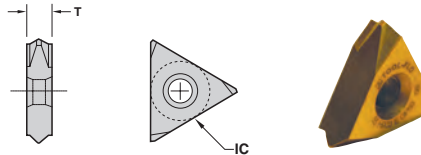

Description	EDP Code	TPI	TPF	IC	T	Conn. No.	Coating						
							C3	C6H	GP3	GP50	AC3	AC50	
TNMC 55 H902 EXT	28564	3.5	2.000	5/8 (15.88)	7.92	3-1/2 - 6-5/8 H90				●			
TNMC 55 H903 EXT	29564	3.5	3.000	5/8 (15.88)	7.92	7 - 8-5/8 H90				●			
TNMC 56 H90S EXT	27Q34	3	1.250	5/8 (15.88)	9.53	2-3/8 - 3-1/2 Slimline				●			
TNMC 55 H902 INT	28568	3.5	2.000	5/8 (15.88)	7.92	3-1/2 - 6-5/8 H90				●			
TNMC 55 H903 INT	29568	3.5	3.000	5/8 (15.88)	7.92	7 - 8-5/8 H90				●			
TNMC 56 H90S INT	27Q38	3	1.250	5/8 (15.88)	9.53	2-3/8 - 3-1/2 Slimline				●			

API ROTARY SHOULDER CONNECTION

TNMA

Straight hole

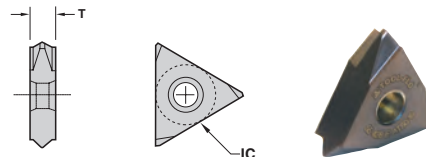

Description	EDP Code	TPI	TPF	IC	T	Conn. No.	Coating						
							C3	C6H	GP3	GP50	AC3	AC50	
TNMA 54 530 EXT	13514	5	3	5/8 (15.88)	6.40	3-1/2 FH, 2-3/8 - 4-1/2 Reg.				●			●
TNMA 55 425 EXT	09554	4	2	5/8 (15.88)	7.92	5-1/2 FH, 6-5/8 FH, 6-5/8 Reg.				●			●
TNMA 55 428 EXT	10554	4	2	5/8 (15.88)	7.92	NC23 - NC50, 2-3/8 - 5-1/2				●			●
TNMA 55 42F EXT*	14554	4	2	5/8 (15.88)	7.92	VO.065*				●			●
TNMA 55 435 EXT	11554	4	3	5/8 (15.88)	7.92	5-1/2, 7-5/8, 8-5/8 Reg.				●			●
TNMA 55 438 EXT	12554	4	3	5/8 (15.88)	7.92	NC56 - NC71				●			●
TNMA 55 530 EXT	13554	5	3	5/8 (15.88)	7.92	3-1/2 FH, 2-3/8 - 4-1/2 Reg.				●			●
TNMA 55 4PAC EXT	15554	4	1.5	5/8 (15.88)	7.92	American Open Hole				●			●
TNMA 54 530 INT	13518	5	3	5/8 (15.88)	6.40	3-1/2 FH, 2-3/8 - 4-1/2 Reg.				●			●
TNMA 55 425 INT	09558	4	2	5/8 (15.88)	7.92	5-1/2 FH, 6-5/8 FH, 6-5/8 Reg.				●			●
TNMA 55 428 INT	10558	4	2	5/8 (15.88)	7.92	NC23 - NC50, 2-3/8 - 5-1/2				●			●
TNMA 55 42F INT*	14558	4	2	5/8 (15.88)	7.92	VO.065*				●			●
TNMA 55 435 INT	11558	4	3	5/8 (15.88)	7.92	5-1/2, 7-5/8, 8-5/8 Reg.				●			●
TNMA 55 438 INT	12558	4	3	5/8 (15.88)	7.92	NC56 - NC71				●			●
TNMA 55 530 INT	13558	5	3	5/8 (15.88)	7.92	3-1/2 FH, 2-3/8 - 4-1/2 Reg.				●			●
TNMA 55 4PAC INT	15558	4	1.5	5/8 (15.88)	7.92	American Open Hole				●			●

*Obsolete thread form - see API Spec 7, 35th Edition, May 1, 1985 Section 9.4.

In an effort to improve our stock standard grade offering, there are periodic changes. Please see current price list for up to date grade offering.

- High performance choice in optimal conditions.
- ▲ Recommended grade under general conditions.

Material	C3	C6H	GP3	GP50	AC3	AC50
Cast Iron						
Non-Ferrous						
Stainless/High Temp						
Steel				▲		●



API ROTARY SHOULDER CONNECTION

TNMC
Countersink hole

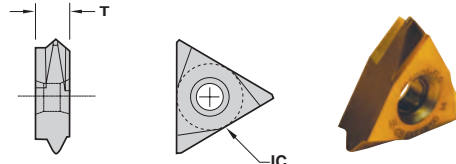

Description	EDP Code	TPI	TPF	IC	T	Conn. No.	Uncoated		TIN Coated		AlTiN Coated	
							C3	C6H	GP3	GP50	AC3	AC50
TNMC 54 530 EXT	13534	5	3	5/8 (15.88)	6.40	3-1/2 FH, 2-3/8 - 4-1/2 Reg.				●		●
TNMC 55 425 EXT	09564	4	2	5/8 (15.88)	7.92	5-1/2 FH, 6-5/8 FH, 6-5/8 Reg.				●		●
TNMC 55 428 EXT	10564	4	2	5/8 (15.88)	7.92	NC23 - NC50, 2-3/8 - 5-1/2				●		●
TNMC 55 42F EXT*	14564	4	2	5/8 (15.88)	7.92	VO.065*						
TNMC 55 435 EXT	11564	4	3	5/8 (15.88)	7.92	5-1/2, 7-5/8, 8-5/8 Reg.				●		●
TNMC 55 438 EXT	12564	4	3	5/8 (15.88)	7.92	NC56 - NC71				●		●
TNMC 55 530 EXT	13564	5	3	5/8 (15.88)	7.92	3-1/2 FH, 2-3/8 - 4-1/2 Reg.				●		●
TNMC 55 4PAC EXT	15564	4	1.5	5/8 (15.88)	7.92	American Open Hole				●		●
TNMC 54 530 INT	13538	5	3	5/8 (15.88)	6.40	3-1/2 FH, 2-3/8 - 4-1/2 Reg.				●		●
TNMC 55 425 INT	09568	4	2	5/8 (15.88)	7.92	5-1/2 FH, 6-5/8 FH, 6-5/8 Reg.				●		●
TNMC 55 428 INT	10568	4	2	5/8 (15.88)	7.92	NC23 - NC50, 2-3/8 - 5-1/2				●		●
TNMC 55 42F INT*	14568	4	2	5/8 (15.88)	7.92	VO.065*						
TNMC 55 435 INT	11568	4	3	5/8 (15.88)	7.92	5-1/2, 7-5/8, 8-5/8 Reg.				●		●
TNMC 55 438 INT	12568	4	3	5/8 (15.88)	7.92	NC56 - NC71				●		●
TNMC 55 530 INT	13568	5	3	5/8 (15.88)	7.92	3-1/2 FH, 2-3/8 - 4-1/2 Reg.				●		●
TNMC 55 4PAC INT	15568	4	1.5	5/8 (15.88)	7.92	American Open Hole				●		●

*Obsolete thread form - see API Spec 7, 35th Edition, May 1, 1985 Section 9.4.

API ROUND

TNMA
Straight hole

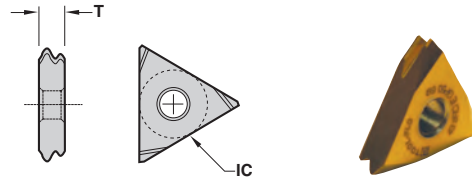

Description	EDP Code	TPI	TPF	IC	T	Uncoated		TIN Coated		AlTiN Coated	
						C3	C6H	GP3	GP50	AC3	AC50
TNMA 43 8RD EXT	32394	8	.750	1/2 (12.7)	4.80				●	●	●
TNMA 43 10RD EXT	34394	10	.750	1/2 (12.7)	4.80				●	●	●
TNMA 54 8RD EXT	32514	8	.750	5/8 (15.88)	6.40				●	●	●
TNMA 43 8RD INT	32398	8	.750	1/2 (12.7)	4.80				●	●	●
TNMA 43 10RD INT	34398	10	.750	1/2 (12.7)	4.80				●	●	●
TNMA 54 8RD INT	32518	8	.750	5/8 (15.88)	6.40				●	●	●

TNMC
Countersink hole

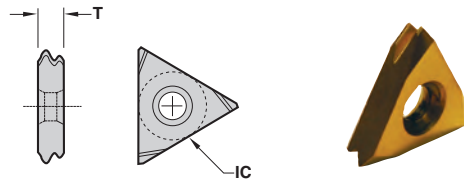

Description	EDP Code	TPI	TPF	IC	T	Uncoated		TIN Coated		AlTiN Coated	
						C3	C6H	GP3	GP50	AC3	AC50
TNMC 43 8RD EXT	32414	8	.750	1/2 (12.7)	4.80				●	●	●
TNMC 43 10RD EXT	34414	10	.750	1/2 (12.7)	4.80				●	●	●
TNMC 54 8RD EXT	32534	8	.750	5/8 (15.88)	6.40				●	●	●
TNMC 43 8RD INT	32418	8	.750	1/2 (12.7)	4.80				●	●	●
TNMC 43 10RD INT	34418	10	.750	1/2 (12.7)	4.80				●	●	●
TNMC 54 8RD INT	32538	8	.750	5/8 (15.88)	6.40				●	●	●

API VAM

TNMA
Straight hole

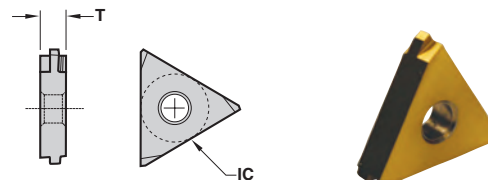

Description	EDP Code	TPI	TPF	IC	T	Uncoated		TIN Coated		AlTiN Coated	
						C3	C6H	GP3	GP50	AC3	AC50
TNMA 43 6VAM EXT	24394	6	.750	1/2 (12.7)	4.80				●		
TNMA 43 8VAM EXT	25394	8	.750	1/2 (12.7)	4.80				●		
TNMA 54 5VAM EXT	23514	5	.750	5/8 (15.88)	6.40				●		
TNMA 43 6VAM INT	24398	6	.750	1/2 (12.7)	4.80				●		
TNMA 43 8VAM INT	25398	8	.750	1/2 (12.7)	4.80				●		
TNMA 54 5VAM INT	23518	5	.750	5/8 (15.88)	6.40				●		

In an effort to improve our stock standard grade offering, there are periodic changes. Please see current price list for up to date grade offering.

- High performance choice in optimal conditions.
- ▲ Recommended grade under general conditions.

Material	C3	C6H	GP3	GP50	AC3	AC50
Cast Iron						
Non-Ferrous						
Stainless/High Temp						
Steel				▲		●



API X-LINE TNMA Straight hole

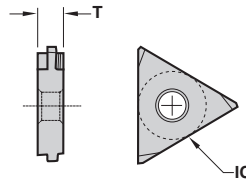

Description	EDP Code	TPI	TPF	IC	T	Conn. No.	Uncoated		TIN Coated		AITIN Coated	
							C3	C6H	GP3	GP50	AC3	AC50
TNMA 54 5XL12 EXT	18514	5	1.250	5/8 (15.88)	6.40	8-5/8 - 10-3/4			●	●		
TNMA 54 6XL15 EXT	19514	6	1.500	5/8 (15.88)	6.40	5 - 7-5/8			●	●		
TNMA 54 6XL75 EXT	20514	6	.750	5/8 (15.88)	6.40	-			●	●		
TNMA 54 5XL12 INT	18518	5	1.250	5/8 (15.88)	6.40	8-5/8 - 10-3/4			●	●		
TNMA 54 6XL15 INT	19518	6	1.500	5/8 (15.88)	6.40	5 - 7-5/8			●	●		
TNMA 54 6XL75 INT	20518	6	.750	5/8 (15.88)	6.40	-			●	●		

GROOVING TNEB Small Diameter

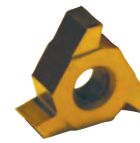
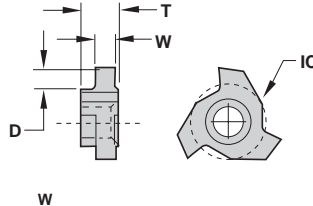

Description	EDP Code	Inch	Metric	D	IC	T	Uncoated		TIN Coated		AITIN Coated	
							C3	C6H	GP3	GP50	AC3	AC50
TNEB 2.52 NGL-40 W.125	LD512500	.125	3,18	1.78	1/3 (8.46)	3.18			●	●		
TNEB 33 NGL-40 W.062	L1206200	.062	1,57	3.05	3/8 (9.52)	4.75			●	●		
TNEB 33 NGL-40 W.094	L1209400	.094	2,39	3.05	3/8 (9.52)	4.75			●	●		
TNEB 33 NGL-40 W.125	L1212500	.125	3,18	3.05	3/8 (9.52)	4.75			●	●		
TNEB 33 NGL-40 W.187	L1218700	.187	4,75	3.05	3/8 (9.52)	4.75			●	●		

TNMA Straight hole

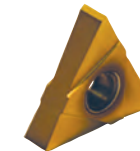
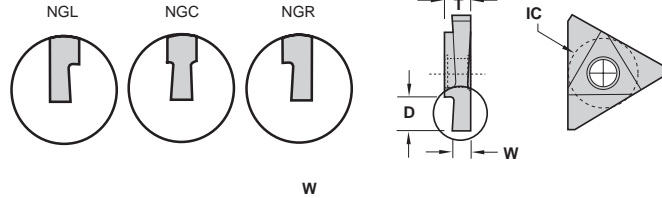

Description	EDP Code	Inch	Metric	D	IC	T	Uncoated		TIN Coated		AITIN Coated	
							C25	C6H	GP3	GP50	AC3	AC50
TNMA 32 NGC W.062	C0806200	.062	1,57	3.81	3/8 (9.52)	3.23			●	●		●
TNMA 32 NGC W.094	C0809400	.094	2,39	3.81	3/8 (9.52)	3.23			●	●		●
TNMA 32 NG W.125	C0912500	.125	3,18	3.81	3/8 (9.52)	3.23			●	●		●
TNMA 33 NG W.187	CK318700	.187	4,75	3.81	3/8 (9.52)	4.80			●	●		●
TNMA 43 NGC W.062	C3906200	.062	1,57	3.96	1/2 (12.7)	4.80			●	●		●
TNMA 43 NGC W.094	C3909400	.094	2,39	5.46	1/2 (12.7)	4.80			●	●		●
TNMA 43 NGC W.125	C3912500	.125	3,18	5.46	1/2 (12.7)	4.80			●	●		●
TNMA 43 NGC W.156	C3915600	.156	3,96	5.46	1/2 (12.7)	4.80			●	●		●
TNMA 43 NG W.187	C3918700	.187	4,75	5.46	1/2 (12.7)	4.80			●	●		●
TNMA 44 NG W.250	C4325000	.250	6,35	5.46	1/2 (12.7)	6.35			●	●		●
TNMA 54 NGC W.125	C5112500	.125	3,18	6.99	5/8 (15.88)	6.40			●	●		●
TNMA 54 NGC W.187	C5118700	.187	4,75	6.99	5/8 (15.88)	6.40			●	●		●
TNMA 54 NG W.250	C5125000	.250	6,35	6.99	5/8 (15.88)	6.40			●	●		●
TNMA 55 NG W.312	C5531200	.312	7,92	6.99	5/8 (15.88)	7.92			●	●		●
TNMA 64 NG W.250	C7425000	.250	6,35	8.51	3/4 (19.05)	6.35			●	●		●
TNMA 66 NG W.375	C7937500	.375	9,53	8.51	3/4 (19.05)	9.53			●	●		●
TNMA 67 NG W.437	C8343700	.437	11,10	8.51	3/4 (19.05)	11.10			●	●		●
TNMA 69 NG W.562	C8856200	.562	14,27	8.51	3/4 (19.05)	14.27			●	●		●
TNMA 32 NGL W.062	L0806200	.062	1,57	3.81	3/8 (9.52)	3.23			●	●		●
TNMA 32 NGL W.094	L0809400	.094	2,39	3.81	3/8 (9.52)	3.23			●	●		●
TNMA 43 NGL W.062	L3906200	.062	1,57	3.96	1/2 (12.7)	4.80			●	●		●
TNMA 43 NGL W.094	L3909400	.094	2,39	5.46	1/2 (12.7)	4.80			●	●		●
TNMA 43 NGL W.125	L3912500	.125	3,18	5.46	1/2 (12.7)	4.80			●	●		●
TNMA 43 NGL W.156	L3915600	.156	3,96	5.46	1/2 (12.7)	4.80			●	●		●
TNMA 54 NGL W.125	L5112500	.125	3,18	6.99	5/8 (15.88)	6.40			●	●		●
TNMA 54 NGL W.187	L5118700	.187	4,75	6.99	5/8 (15.88)	6.40			●	●		●
TNMA 32 NGR W.062	R0806200	.062	1,57	3.81	3/8 (9.52)	3.23			●	●		●
TNMA 32 NGR W.094	R0809400	.094	2,39	3.81	3/8 (9.52)	3.23			●	●		●
TNMA 43 NGR W.062	R3906200	.062	1,57	3.96	1/2 (12.7)	4.80			●	●		●
TNMA 43 NGR W.094	R3909400	.094	2,39	5.46	1/2 (12.7)	4.80			●	●		●
TNMA 43 NGR W.125	R3912500	.125	3,18	5.46	1/2 (12.7)	4.80			●	●		●
TNMA 43 NGR W.156	R3915600	.156	3,96	5.46	1/2 (12.7)	4.80			●	●		●
TNMA 54 NGR W.125	R5112500	.125	3,18	6.99	5/8 (15.88)	6.40			●	●		●
TNMA 54 NGR W.187	R5118700	.187	4,75	6.99	5/8 (15.88)	6.40			●	●		●

In an effort to improve our stock standard grade offering, there are periodic changes. Please see current price list for up to date grade offering.

Cast Iron	●
Non-Ferrous	●
Stainless/High Temp	●
Steel	▲



GROOVING

TNMC

Countersink hole

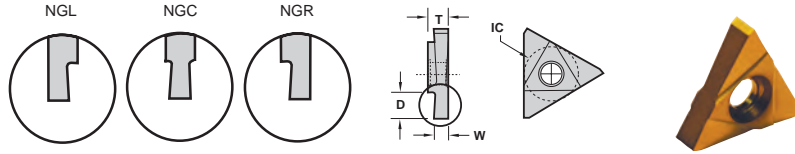

Description	EDP Code	Inch	Metric	D	IC	T						
							C3	C6H	GP3	GP50	AC3	AC50
TNMC 32 NGC W.062	C0906200	.062	1,57	3.81	3/8 (9.52)	3.23						
TNMC 32 NGC W.094	C0909400	.094	2,39	3.81	3/8 (9.52)	3.23						
TNMC 32 NG W.125	C0912500	.125	3,18	3.81	3/8 (9.52)	3.23						
TNMC 33 NG W.187	CK818700	.187	4,75	3.81	3/8 (9.52)	4.80						
TNMC 43 NGC W.062	C4106200	.062	1,57	3.96	1/2 (12.7)	4.80						
TNMC 43 NGC W.094	C4109400	.094	2,39	5.46	1/2 (12.7)	4.80						
TNMC 43 NGC W.125	C4112500	.125	3,18	5.46	1/2 (12.7)	4.80						
TNMC 43 NGC W.156	C4115600	.156	3,96	5.46	1/2 (12.7)	4.80						
TNMC 43 NG W.187	C4118700	.187	4,75	5.46	1/2 (12.7)	4.80						
TNMC 44 NG W.250	C4425000	.250	6,35	5.46	1/2 (12.7)	6.35						
TNMC 54 NGC W.125	C5312500	.125	3,18	6.99	5/8 (15.88)	6.40						
TNMC 54 NGC W.187	C5318700	.187	4,75	6.99	5/8 (15.88)	6.40						
TNMC 54 NG W.250	C5325000	.250	6,35	6.99	5/8 (15.88)	6.40						
TNMC 55 NG W.312	C5631200	.312	7,92	6.99	5/8 (15.88)	7.92						
TNMC 64 NG W.250	C7525000	.250	6,35	8.51	3/4 (19.05)	6.35						
TNMC 66 NG W.375	C8037500	.375	9,53	8.51	3/4 (19.05)	9.53						
TNMC 67 NG W.437	C8443700	.437	11,10	8.51	3/4 (19.05)	11.10						
TNMC 69 NG W.562	C8956200	.562	14,27	8.51	3/4 (19.05)	14.27						
TNMC 32 NGL W.062	L0906200	.062	1,57	3.81	3/8 (9.52)	3.23						
TNMC 32 NGL W.094	L0909400	.094	2,39	3.81	3/8 (9.52)	3.23						
TNMC 43 NGL W.062	L4106200	.062	1,57	3.96	1/2 (12.7)	4.80						
TNMC 43 NGL W.094	L4109400	.094	2,39	5.46	1/2 (12.7)	4.80						
TNMC 43 NGL W.125	L4112500	.125	3,18	5.46	1/2 (12.7)	4.80						
TNMC 43 NGL W.156	L4115600	.156	3,96	5.46	1/2 (12.7)	4.80						
TNMC 54 NGL W.125	L5312500	.125	3,18	6.99	5/8 (15.88)	6.40						
TNMC 54 NGL W.187	L5318700	.187	4,75	6.99	5/8 (15.88)	6.40						
TNMC 32 NGR W.062	R0906200	.062	1,57	3.81	3/8 (9.52)	3.23						
TNMC 32 NGR W.094	R0909400	.094	2,39	3.81	3/8 (9.52)	3.23						
TNMC 43 NGR W.062	R4106200	.062	1,57	3.96	1/2 (12.7)	4.80						
TNMC 43 NGR W.094	R4109400	.094	2,39	5.46	1/2 (12.7)	4.80						
TNMC 43 NGR W.125	R4112500	.125	3,18	5.46	1/2 (12.7)	4.80						
TNMC 43 NGR W.156	R4115600	.156	3,96	5.46	1/2 (12.7)	4.80						
TNMC 54 NGR W.125	R5312500	.125	3,18	6.99	5/8 (15.88)	6.40						
TNMC 54 NGR W.187	R5318700	.187	4,75	6.99	5/8 (15.88)	6.40						



TPMA

Straight hole - Positive Rake

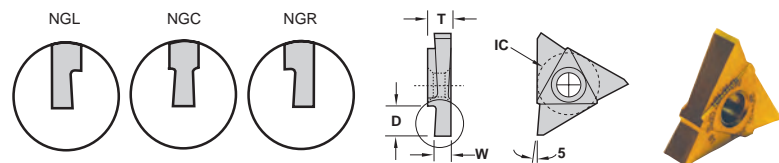

Description	EDP Code	Inch	Metric	D	IC	T						
							C3	C6H	GP3	GP50	AC3	AC50
TPMA 32 NGC W.062	C1006200	.062	1,57	3.81	3/8 (9.52)	3.23						
TPMA 32 NGC W.094	C1009400	.094	2,39	3.81	3/8 (9.52)	3.23						
TPMA 32 NG W.125	C1012500	.125	3,18	3.81	3/8 (9.52)	3.23						
TPMA 33 NG W.187	CL318700	.187	4,75	3.81	3/8 (9.52)	4.80						
TPMA 43 NGC W.062	C4006200	.062	1,57	3.96	1/2 (12.7)	4.80						
TPMA 43 NGC W.094	C4009400	.094	2,39	5.46	1/2 (12.7)	4.80						
TPMA 43 NGC W.125	C4012500	.125	3,18	5.46	1/2 (12.7)	4.80						
TPMA 43 NG W.187	C4018700	.187	4,75	5.46	1/2 (12.7)	4.80						
TPMA 44 NG W.250	C4525000	.250	6,35	5.46	1/2 (12.7)	6.35						
TPMA 54 NG W.250	C5225000	.250	6,35	6.99	5/8 (15.88)	6.40						
TPMA 55 NG W.312	C5631200	.312	7,92	6.99	5/8 (15.88)	7.92						
TPMA 32 NGR W.062	R1006200	.062	1,57	3.81	3/8 (9.52)	3.23						
TPMA 32 NGR W.094	R1009400	.094	2,39	3.81	3/8 (9.52)	3.23						
TPMA 43 NGR W.062	R4006200	.062	1,57	3.96	1/2 (12.7)	4.80						
TPMA 43 NGR W.094	R4009400	.094	2,39	5.46	1/2 (12.7)	4.80						
TPMA 43 NGR W.125	R4012500	.125	3,18	5.46	1/2 (12.7)	4.80						

In an effort to improve our stock standard grade offering, there are periodic changes. Please see current price list for up to date grade offering.

- High performance choice in optimal conditions.
- ▲ Recommended grade under general conditions.

Cast Iron												
Non-Ferrous												
Stainless/High Temp												
Steel												



GROOVING

TPMC

Countersink hole - Positive Rake

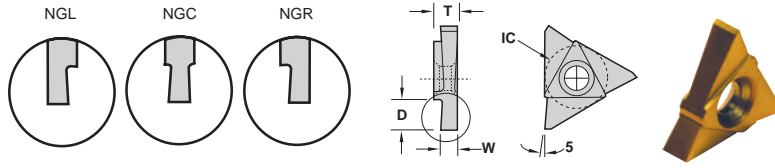

Description	EDP Code	Inch	Metric	D	IC	T	W					
							C3	C6H	GP3	GP50	AC3	AC50
TPMC 32 NGC W.062	C1106200	.062	1,57	3.81	3/8 (9.52)	3.23						
TPMC 32 NGC W.094	C1109400	.094	2,39	3.81	3/8 (9.52)	3.23						
TPMC 32 NG W.125	C1112500	.125	3,18	3.81	3/8 (9.52)	3.23						
TPMC 33 NG W.187	CL818700	.187	4,75	3.81	3/8 (9.52)	4.80						
TPMC 43 NGC W.062	C4206200	.062	1,57	3.96	1/2 (19.05)	4.80						
TPMC 43 NGC W.094	C4209400	.094	2,39	5.46	1/2 (19.05)	4.80						
TPMC 43 NGC W.125	C4212500	.125	3,18	5.46	1/2 (19.05)	4.80						
TPMC 43 NG W.187	C4218700	.187	4,75	5.46	1/2 (19.05)	4.80						
TPMC 44 NG W.250	C4625000	.250	6,35	5.46	1/2 (19.05)	6.35						
TPMC 54 NG W.250	C5425000	.250	6,35	6.99	5/8 (15.88)	6.40						
TPMC 55 NG W.312	CP631200	.312	7,92	6.99	5/8 (15.88)	7.92						
TPMC 32 NGL W.062	L1106200	.062	1,57	3.81	3/8 (9.52)	3.23						
TPMC 32 NGL W.094	L1109400	.094	2,39	3.81	3/8 (9.52)	3.23						
TPMC 43 NGL W.062	L4206200	.062	1,57	3.96	1/2 (19.05)	4.80						
TPMC 43 NGL W.094	L4209400	.094	2,39	5.46	1/2 (19.05)	4.80						
TPMC 43 NGL W.125	L4212500	.125	3,18	5.46	1/2 (19.05)	4.80						
TPMC 32 NGR W.062	R1106200	.062	1,57	3.81	3/8 (9.52)	3.23						
TPMC 32 NGR W.094	R1109400	.094	2,39	3.81	3/8 (9.52)	3.23						
TPMC 43 NGR W.062	R4206200	.062	1,57	3.96	1/2 (19.05)	4.80						
TPMC 43 NGR W.094	R4209400	.094	2,39	5.46	1/2 (19.05)	4.80						
TPMC 43 NGR W.125	R4212500	.125	3,18	5.46	1/2 (19.05)	4.80						

NPT

TNMA

Straight hole

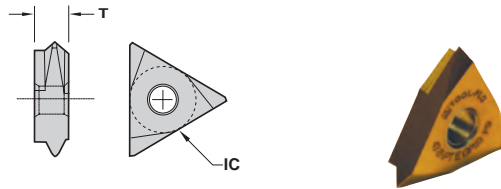

Description	EDP Code	Pipe Size	TPI	TPF	IC	T	W					
							C3	C6H	GP3	GP50	AC3	AC50
TNMA 43 8NPT EXT	3639084	2.5" and up	8	.750	1/2 (19.05)	4.80						
TNMA 43 11.5NPT EXT	3639114	1" - 2"	11.5	.750	1/2 (19.05)	4.80						
TNMA 43 8NPT INT	3639088	2.5" and up	8	.750	1/2 (19.05)	4.80						
TNMA 43 11.5NPT INT	3639118	1" - 2"	11.5	.750	1/2 (19.05)	4.80						

TNMC

Countersink hole

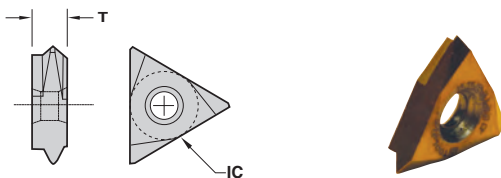

Description	EDP Code	Pipe Size	TPI	TPF	IC	T	W					
							C3	C6H	GP3	GP50	AC3	AC50
TNMC 43 8NPT EXT	3641084	2.5" and up	8	.750	1/2 (19.05)	4.80						
TNMC 43 11.5NPT EXT	3641114	1" - 2"	11.5	.750	1/2 (19.05)	4.80						
TNMC 43 8NPT INT	3641088	2.5" and up	8	.750	1/2 (19.05)	4.80						
TNMC 43 11.5NPT INT	3641118	1" - 2"	11.5	.750	1/2 (19.05)	4.80						

60° V-THREADING

TNEB

Small Diameter

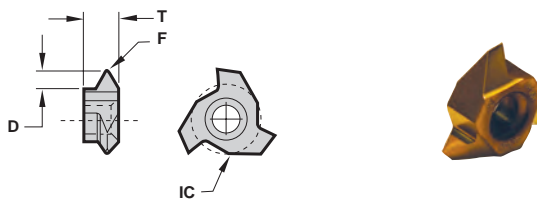

Description	EDP Code	TPI	F	IC	T	W						
						C3	C6H	GP3	GP50	AC3	AC50	
TNEB 2.52 NVL-40	01D5000	3.6-0.8	0.08/0.13	1/3 (8.47)	3.18							
TNEB 33 NVL-40	0112000	1.5-5.0	0.08/0.13	3/8 (9.52)	4.75							

In an effort to improve our stock standard grade offering, there are periodic changes. Please see current price list for up to date grade offering.

- High performance choice in optimal conditions.
- ▲ Recommended grade under general conditions.

Material	W					
	C3	C6H	GP3	GP50	AC3	AC50
Cast Iron						
Non-Ferrous						
Stainless/High Temp						
Steel				●		



60° V-THREADING

TNMA
Straight hole

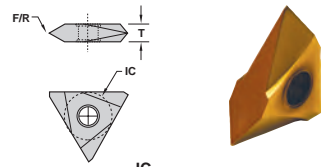

Description	EDP Code	TPI	F or R	IC	T	Coatings					
						C25	GP4	GP3	GP50	AC3	AC50
TNMA 32 NV	0108000	1.25-3.5	0.08/0.13 Flat	3/8 (9.52)	3.23	●	●	●	●	●	●
TNMA 43 NV	0139000	1.3-5.0	0.13/0.18 Flat	1/2 (19.05)	4.80	●	●	●	●	●	●
TNMA 43 NV .010R	0139R10	1.3-6.25	0.25 Radius	1/2 (19.05)	4.80			●	●	●	●
TNMA 44 NV	0143000	1.3-6.25	0.13/0.23 Flat	1/2 (19.05)	6.35			●	●	●	●
TNMA 54 NV	0151000	1.3-6.25	0.20/0.25 Flat	5/8 (15.88)	6.40	●	●	●	●	●	●
TNMA 54 NV .010R	0151R10	1.3-6.25	0.25 Radius	5/8 (15.88)	6.40			●	●	●	●
TNMA 54 NV .020R	0151R20	2.0-6.25	0.51 Radius	5/8 (15.88)	6.40			●	●	●	●
TNMA 54 NV .025R	0151R25	3.5-6.25	0.64 Radius	5/8 (15.88)	6.40			●	●	●	●
TNMA 54 NV .038R	0151R38	4.0-6.25	0.97 Radius	5/8 (15.88)	6.40			●	●	●	●
TNMA 64 NV	0174000	1.3-6.25	0.20/0.25 Flat	3/4 (19.05)	6.40					●	●
TNMA 66 NV	0179000	2.0-8.0	0.20/0.25 Flat	3/4 (19.05)	9.53					●	●

TNMC
Countersink hole

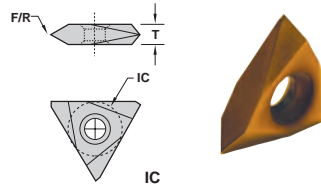

Description	EDP Code	TPI	F or R	IC	T	Coatings					
						C25	GP4	GP3	GP50	AC3	AC50
TNMC 32 NV	0109000	1.25-3.5	0.08/0.13 Flat	3/8 (9.52)	3.23	●	●	●	●	●	●
TNMC 43 NV	0141000	1.3-5.0	0.13/0.18 Flat	1/2 (19.05)	4.80	●	●	●	●	●	●
TNMC 43 NV .010R	0141R10	1.3-6.25	0.25 Radius	1/2 (19.05)	4.80			●	●	●	●
TNMC 44 NV	0144000	1.2-6.25	0.08/0.13 Flat	1/2 (19.05)	6.35			●	●	●	●
TNMC 54 NV	0153000	1.3-6.25	0.20/0.25 Flat	5/8 (15.88)	6.40	●	●	●	●	●	●
TNMC 54 NV .010R	0153R10	1.3-6.25	0.25 Radius	5/8 (15.88)	6.40			●	●	●	●
TNMC 54 NV .020R	0153R20	2.0-6.25	0.51 Radius	5/8 (15.88)	6.40			●	●	●	●
TNMC 54 NV .025R	0153R25	3.5-6.25	0.64 Radius	5/8 (15.88)	6.40			●	●	●	●
TNMC 54 NV .038R	0153R38	4.0-6.25	0.97 Radius	5/8 (15.88)	6.40			●	●	●	●
TNMC 64 NV	0175000	1.3-6.25	0.20/0.25 Flat	3/4 (19.05)	6.40					●	●
TNMC 66 NV	0180000	2.0-8.0	0.20/0.25 Flat	3/4 (19.05)	9.53					●	●

TPMA
Straight hole - Positive Rake

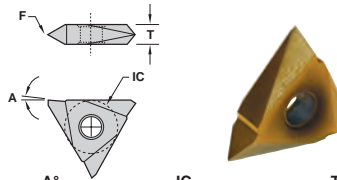

Description	EDP Code	TPI	F	A°	IC	T	Coatings					
							C25	C6H	GP3	GP50	AC3	AC50
TPMA 32 NV	0110000	1.25-3.5	0.08/0.13	5	3/8 (9.52)	3.23			●	●	●	●
TPMA 32 NV-10	0110100	1.25-3.5	0.08/0.13	10	3/8 (9.52)	3.23			●	●	●	●
TPMA 43 NV	0140000	1.3-5.0	0.13/0.18	5	1/2 (19.05)	4.80	●		●	●	●	●
TPMA 43 NV-10	0140100	1.3-5.0	0.13/0.18	10	1/2 (19.05)	4.80			●	●	●	●
TPMA 54 NV	0152000	1.3-6.25	0.20/0.25	5	1/2 (19.05)	6.40			●	●	●	●
TPMA 66 NV	0181000	2.0-8.0	0.20/0.25	5	3/4 (19.05)	9.53			●	●	●	●

TPMC
Countersink hole - Positive Rake

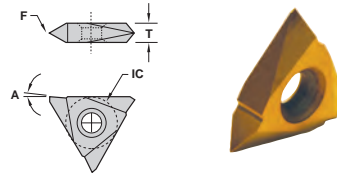

Description	EDP Code	TPI	F	A°	IC	T	Coatings					
							C3	C6H	GP3	GP50	AC3	AC50
TPMC 32 NV	0111000	1.25-3.5	0.08/0.13	5	3/8 (9.52)	3.23			●	●	●	●
TPMC 32 NV-10	0111100	1.25-3.5	0.08/0.13	10	3/8 (9.52)	3.23			●	●	●	●
TPMC 43 NV	0142000	1.3-5.0	0.13/0.18	5	1/2 (19.05)	4.80			●	●	●	●
TPMC 43 NV-10	0142100	1.3-5.0	0.08/0.13	10	1/2 (19.05)	4.80			●	●	●	●
TPMC 54 NV	0154000	1.3-6.25	0.20/0.25	5	1/2 (19.05)	6.40			●	●	●	●
TPMC 66 NV	0182000	2.0-8.0	0.20/0.25	5	3/4 (19.05)	9.53			●	●	●	●

55° WHITWORTH

TNMA/C

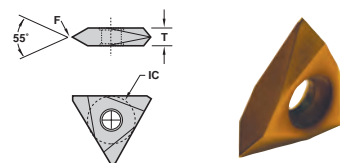

Description	EDP Code	TPI	F	IC	T	Coatings					
						C3	C6H	GP3	GP50	AC3	AC50
TNMA 43 NV-55	0139055	1.2-5.0	0.13/0.18	1/2 (19.05)	4.80			●	●	●	●
TNMC 43 NV-55	0141055	1.2-5.0	0.13/0.18	1/2 (19.05)	4.80			●	●	●	●

In an effort to improve our stock standard grade offering, there are periodic changes. Please see current price list for up to date grade offering.

- High performance choice in optimal conditions.
- ▲ Recommended grade under general conditions.

Material	Cast Iron	Non-Ferrous	Stainless/High Temp	Steel
Coatings	▲	▲	▲	▲

ON-EDGE



EXTERNAL HOLDER

MTHOR/L

Threading/Grooving

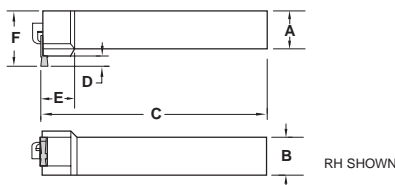

PARTS

Description	EDP Code	Insert	A	B	C	D	E	F	Lock Pin	Clamp	Clamp Screw
MTHOR-2525M4	955025M56	T_MA/C 43	25	25	150	4.83	18.80	38.10	NLM44	CLM20	STCM11
MTHOL-2525M4	954025M56	T_MA/C 43	25	25	150	4.83	18.80	38.10	NLM44	CLM20	STCM11
MTHOR-3232M4	95502056	T_MA/C 43	32	32	170	4.83	25.15	44.45	NLM44	CLM20	STCM11
MTHOR-2525M5	95501664	T_MA/C 54	25	25	150	6.10	25.15	38.10	NLM56	CLM20	STCM11
MTHOL-2525M5	95401664	T_MA/C 54	25	25	150	6.10	25.15	38.10	NLM56	CLM20	STCM11
MTHOR-3232M5	95502064	T_MA/C 54	32	32	170	6.10	25.15	44.45	NLM56	CLM20	STCM11

MTVOR/L

Threading/Grooving

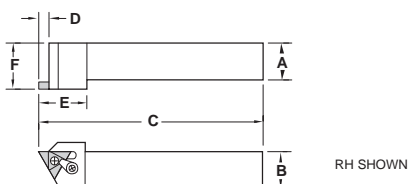

PARTS

Description	EDP Code	Insert	A	B	C	D	E	F	Lock Pin	Clamp	Clamp Screw
MTVOR-2020M3	960020M48	T_MA/C 32	20	20	150	3,8	27,4	31,7	NLM33	CLM6	STCM9
MTVOL-2020M3	959020M48	T_MA/C 32	20	20	150	3,8	27,4	31,7	NLM33	CLM6	STCM9
MTVOR-2525M3	960025M48	T_MA/C 32	25	25	150	3,8	27,4	31,7	NLM33	CLM6	STCM9
MTVOL-2525M3	959025M48	T_MA/C 32	25	25	150	3,8	27,4	31,7	NLM33	CLM6	STCM9
MTVOR-2020M4	960020M56	T_MA/C 32	20	20	150	3,8	27,4	31,7	NLM33	CLM6	STCM9
MTVOL-2020M4	959020M56	T_MA/C 32	20	20	150	3,8	27,4	31,7	NLM33	CLM6	STCM9
MTVOR-2525M4	960025M56	T_MA/C 43	25	25	150	5,8	31,2	31,7	NLM44	CLM6	XNSM0515
MTVOL-2525M4	969025M56	T_MA/C 43	25	25	150	5,8	31,2	31,7	NLM44	CLM6	XNSM0515
MTVOR-3232M4	960032M56	T_MA/C 43	32	32	180	5,8	31,2	38,1	NLM44	CLM6	XNSM0515
MTVOR-2525M5	960025M64	T_MA/C 54	25	25	150	7,3	35,8	31,7	NLM56	CLM20	STCM11
MTVOL-2525M5	959025M64	T_MA/C 54	25	25	150	7,3	35,8	31,7	NLM56	CLM20	STCM11
MTVOR-3232M5	960032M64	T_MA/C 54	32	32	170	7,3	35,8	38,1	NLM56	CLM20	STCM11
MTVOR-2525M55	960025M66	T_MA/C 55	25	25	170	7,9	35,8	38,1	NLM56	CLM20	STCM11
MTVOR-3232M6	960032M76	T_MA/C 66	32	32	170	9,6	41,1	38,1	NLM66	CLM12	XNSM0825
MTVOL-3232M6	960032M76	T_MA/C 66	32	32	170	9,6	41,1	38,1	NLM66	CLM12	XNSM0825
MTVOR-4040M6	960040M76	T_MA/C 66	32	32	170	9,6	41,1	38,1	NLM66	CLM12	XNSM0825

EXTERNAL HOLDER

STVOR/L

Threading/Grooving

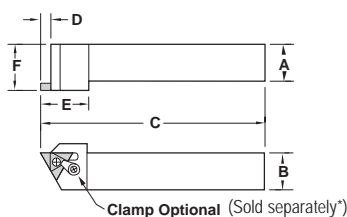

PARTS

Description	EDP Code	Insert	A	B	C	D	E	F	Screw	Clamp	Clamp Screw
STVOR-2020M3	980020M48	T_MC 32	20	20	150	5,8	31,2	31,7	SD-2	CLM6	STCM9
STVOL-2020M3	978020M48	T_MC 32	20	20	150	5,8	31,2	31,7	SD-2	CLM6	STCM9
STVOR-2525M3	980125M48	T_MC 32	25	25	150	5,8	31,2	38,1	SD-2	CLM6	STCM9
STVOL-2525M3	980125M48	T_MC 32	25	25	150	5,8	31,2	38,1	SD-2	CLM6	STCM9
STVOR-2020M4	980020M56	T_MC 43	20	20	150	5,8	31,2	31,7	SD-2	CLM6	STCM9
STVOR-2525M4	980125M56	T_MC 43	25	25	150	5,8	31,2	31,7	SD-2	CLM6	STCM9
STVOL-2525M4	978025M56	T_MC 43	25	25	150	5,8	31,2	31,7	SD-2	CLM6	STCM9
STVOR-3232M4	980132M56	T_MC 43	32	32	170	5,8	31,2	38,1	SD-2	CLM6	STCM9
STVOR-2525M5	980125M64	T_MC 54	25	25	150	7,4	36,3	31,7	SD-3	CLM20	STCM11
STVOL-2525M5	978025M64	T_MC 54	25	25	150	7,4	36,3	31,7	SD-3	CLM20	STCM11
STVOR-3232M5	980132M64	T_MC 54	32	32	150	7,4	36,3	38,1	SD-3	CLM20	STCM11
STVOR-3232M55	980132M66	T_MC 55	32	32	170	9,4	36,3	38,1	SD-3	CLM20	STCM11
STVOR-3232M6	980132M76	T_MC 66	32	32	170	9,4	41,1	38,1	SD-4	CLM9	STCM8
STVOR-4040M6	980140M76	T_MC 66	32	32	170	9,4	41,1	38,1	SD-4	CLM9	STCM8



INTERNAL BAR

GTB

Threading/Grooving

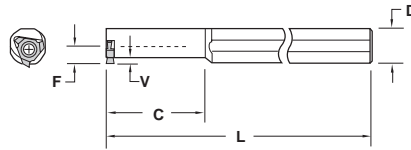

Description	EDP Code	Insert	Min. Bore	F	V	L	C	D	Torx Screw
GTB-062	93605000	TNEB 2.52	21.89	7.92	1.78	150	50.80	15.88	PT-324
GTB-075	93605200	TNEB 33	27.86	9.53	3.05	150	50.80	19.05	PT-324

INTERNAL BAR

SI-MTHOR/L

Threading/Grooving

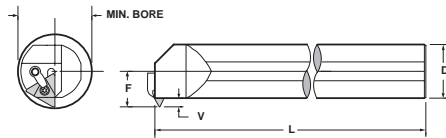

PARTS

Description	EDP Code	Insert	Min. Bore	D	L	F	V	Lock Pin	Clamp	Clamp Screw
SI-MTHOR-25M3	973025M48	T_MA 32	35,1	25	350	17,5	3,0	NLM33	CLM6	XNSM0515
SI-MTHOL-25M3	972025M48	T_MA 32	35,1	25	350	17,5	3,0	NLM33	CLM6	XNSM0515
SI-MTHOR-32M4	973032M56	T_MA 43	46,1	32	350	22,5	4,8	NLM44	CLM6	STCM9
SI-MTHOL-32M4	972032M56	T_MA 43	46,1	32	350	22,5	4,8	NLM44	CLM6	STCM9
SI-MTHOR-40M4	973040M56	T_MA 43	48,1	40	350	25,9	4,8	NLM44	CLM6	XNSM0515
SI-MTHOL-40M4	972040M56	T_MA 43	48,1	40	350	25,9	4,8	NLM44	CLM6	XNSM0515
SI-MTHOR-50M4	973050M56	T_MA 43	69,9	50	400	32,9	4,8	NLM44	CLM6	XNSM0515
SI-MTHOR-60M4	973060M56	T_MA 43	82,6	60	400	36,8	4,8	NLM44	CLM6	XNSM0515
SI-MTHOR-63M4	973063M56	T_MA 43	89,0	63	400	40,0	4,8	NLM44	CLM6	XNSM0515
SI-MTHOR-40M5	973040M64	T_MA 54	48,1	40	350	25,9	5,6	NLM56	CLM20	STCM11
SI-MTHOL-40M5	972040M64	T_MA 54	48,1	40	350	25,9	5,6	NLM56	CLM20	STCM11
SI-MTHOR-50M5	973050M64	T_MA 54	69,9	50	400	32,9	5,6	NLM56	CLM20	STCM11
SI-MTHOR-60M5	973060M64	T_MA 54	82,6	60	400	36,8	5,6	NLM56	CLM20	STCM11
SI-MTHOR-63M5	973063M64	T_MA 54	89,0	63	400	40,0	5,6	NLM56	CLM20	STCM11
SI-MTHOR-50M6	973050M76	T_MA 66	69,9	50	400	32,9	8,1	NLM66	CLM12	XNSM0825
SI-MTHOR-63M6	973063M76	T_MA 66	89,0	63	400	40,0	8,1	NLM66	CLM12	XNSM0825



INTERNAL BAR

SI-STHOR/L

Threading/Grooving

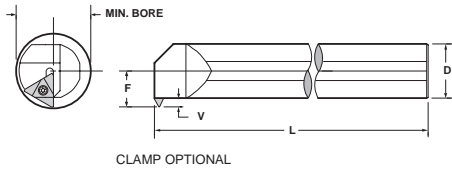

RH SHOWN

PARTS

Description	EDP Code	Insert	Min. Bore	D	L	F	V	Clamp		
								Screw	Clamp	Screw
SI-STHOR-25M3	976025M48	T_MC 32	35,1	25	350	17,4	3,1	SD-1	CLM6	STCM9
SI-STHOL-25M3	975025M48	T_MC 32	35,1	25	350	17,4	3,1	SD-1	CLM6	STCM9
SI-STHOR-32M4	976032M56	T_MC 43	46,1	32	350	22,5	4,8	SD-2	CLM6	STCM9
SI-STHOL-32M4	975032M56	T_MC 43	46,1	32	350	22,5	4,8	SD-2	CLM6	STCM9
SI-STHOR-40M4	976040M56	T_MC 43	48,1	40	350	25,9	4,8	SD-2	CLM6	STCM9
SI-STHOL-40M4	975040M56	T_MC 43	48,1	40	350	25,9	4,8	SD-2	CLM6	STCM9
SI-STHOR-40M5	976040M64	T_MC 54	48,1	40	350	26,8	5,6	SD-3	CLM20	STCM11
SI-STHOL-40M5	975040M64	T_MC 54	56,9	40	350	33,6	5,6	SD-3	CLM20	STCM11
SI-STHOR-50M5	976050M64	T_MC 54	69,9	50	400	33,6	5,6	SD-3	CLM20	STCM11
SI-STHOR-60M6	976060M76	T_MC 66	82,6	60	400	40,6	8,1	SD-4	TC-380	STC-19

*Clamp optional and sold separately.

INTERCHANGEABLE HEADS

H-MTHOR/L*

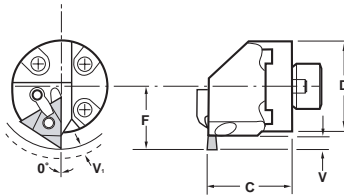

RH SHOWN

PARTS

Description	EDP Code	Insert	D	C	F	Min. Bore	Clamp		
							Clamp	Clamp Screw	Lock Pin
H25M-MTHOR-3	9IH73025M48	T_MA/C 32	25	41.28	17.48	42.93	CLM6	XNSM0515	NLM33
H32M-MTHOR-3	9IH73032M48	T_MA/C 32	32	41.28	20.27	45.42	CLM6	XNSM0515	NLM33
H40M-MTHOR-3	9IH73040M48	T_MA/C 32	40	41.28	23.44	47.63	CLM6	XNSM0515	NLM33
H32M-MTHOR-4	9IH73032M56	T_MA/C 43	32	41.28	26.62	61.47	CLM6	XNSM0515	NLM44
H40M-MTHOR-4	9IH73040M56	T_MA/C 43	40	41.28	29.79	66.68	CLM6	XNSM0515	NLM44
H44M-MTHOR-4	9IH73044M56	T_MA/C 43	44	41.28	32.97	73.03	CLM6	XNSM0515	NLM44
H50M-MTHOR-4	9IH73050M56	T_MA/C 43	50	41.28	36.14	73.03	CLM6	XNSM0515	NLM44
H60M-MTHOR-4	9IH73060M56	T_MA/C 43	60	41.28	42.49	85.73	CLM6	XNSM0515	NLM44
H40M-MTHOR-5	9IH73040M64	T_MA/C 54	40	41.28	29.79	81.28	CLM20	STCM11	NLM56
H44M-MTHOR-5	9IH73044M64	T_MA/C 54	44	41.28	32.97	82.55	CLM20	STCM11	NLM56
H50M-MTHOR-5	9IH73050M64	T_MA/C 54	50	41.28	36.14	82.55	CLM20	STCM11	NLM56
H60M-MTHOR-5	9IH73060M64	T_MA/C 54	60	41.28	42.49	85.73	CLM20	STCM11	NLM56

*Left hand quoted on request.

HS-MTHOR/L*

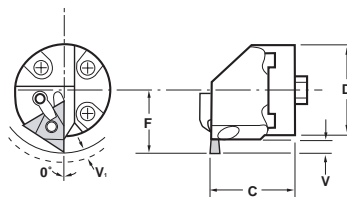

RH SHOWN

PARTS

Description	EDP Code	Insert	D	C	F	Min. Bore	Clamp		
							Clamp	Clamp Screw	Lock Pin
HS25-MTHOR-3	9IHS73025M48	TNMA/C 32	25	24.89	17.22	42.93	CLM6	XNSM0515	NLM33
HS32-MTHOR-3	9IHS73032M48	TNMA/C 32	32	32.00	20.32	45.42	CLM6	XNSM0515	NLM33
HS40-MTHOR-3	9IHS73040M48	TNMA/C 32	40	32.00	23.70	47.63	CLM6	XNSM0515	NLM33
HS32-MTHOR-4	9IHS73032M56	TNMA/C 43	32	32.00	26.67	61.47	CLM6	XNSM0515	NLM44
HS40-MTHOR-4	9IHS73040M56	TNMA/C 43	40	32.00	30.56	66.68	CLM6	XNSM0515	NLM44
HS50-MTHOR-4	9IHS73050M56	TNMA/C 43	50	39.88	35.89	73.03	CLM6	XNSM0515	NLM44
HS60-MTHOR-4	9IHS73060M56	TNMA/C 43	60	39.88	40.72	85.73	CLM6	XNSM0515	NLM44
HS40-MTHOR-5	9IHS73040M64	TNMA/C 54	40	32.00	30.56	81.28	CLM20	STCM11	NLM56
HS50-MTHOR-5	9IHS73050M64	TNMA/C 54	50	39.88	35.89	82.55	CLM20	STCM11	NLM56
HS60-MTHOR-5	9IHS73060M64	TNMA/C 54	60	39.88	40.72	85.73	CLM20	STCM11	NLM56

*Left hand quoted on request.

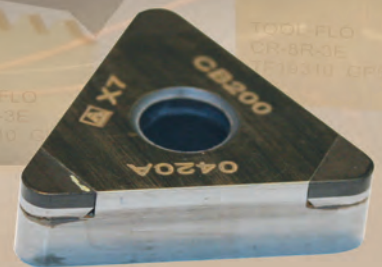
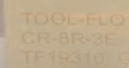
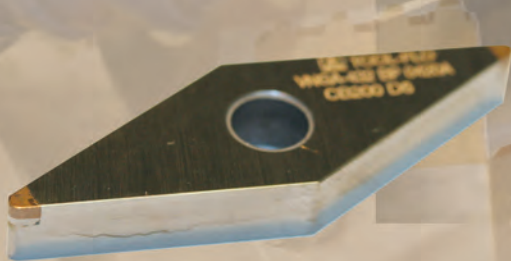
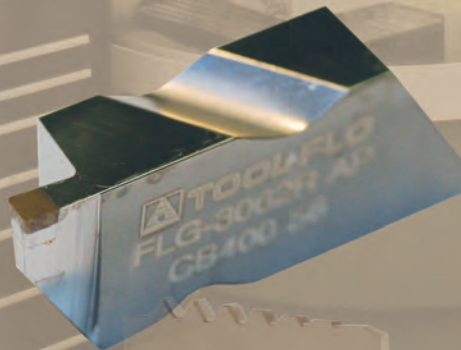
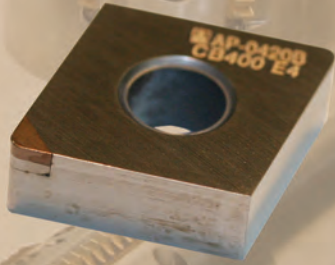

PCBN



PCBN - Polycrystalline Cubic Boron Nitride Insert Nomenclature Chart

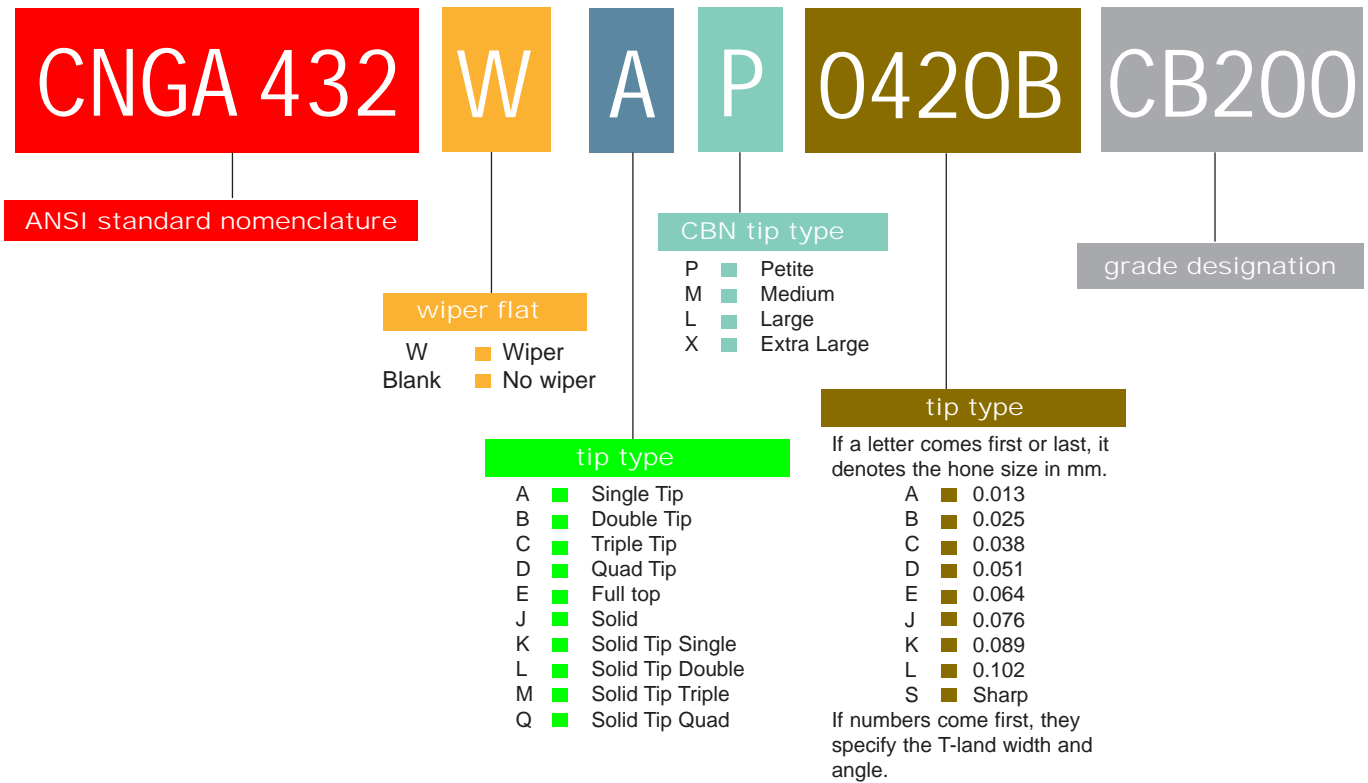

PCBN Grade Descriptions

Grades	Descriptions
CB200	A high CBN content, PCBN tip brazed onto a carbide insert. Superior impact resistance. Ideally suited for machining cast iron and powder metal alloys, fully pearlitic gray cast iron, chilled irons; excellent results in high temperature alloys such as Inconel with an up sharp edge. Apply to tool steels and hard steels 45 HRC and higher; high chrome alloy steels. Application ranges from continuous to highly interrupted cuts.
CB400	A low CBN content, PCBN tip brazed onto a carbide insert. Ideally suited for roughing to finishing of hardened steels 45 HRC and higher. Use on bearing steel, hot and cold work steels, die steels, case hardened steels, carburized and nitrided irons.
CB410	PCBN tip brazed onto a carbide insert. Ideally suited for roughing to finishing of hardened steels 45 HRC and higher. Use on bearing steel, hot and cold work steels, die steels, case hardened steels, carburized and nitrided irons.



SINGLE TIP PCBN

CNGA

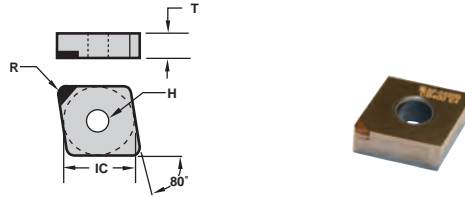

For Holders see pg. 184-204.

Description	ISO Description	EDP Code	IC	R	T	H	Edge Prep	CB200	CB400
CNGA-431 APS	CNGA-120404 APS	CBGAM1APS	1/2	0.38	4.75	5.16	Sharp	●	●
CNGA-432 APS	CNGA-120408 APS	CBGAM2APS	1/2	0.79	4.75	5.16	Sharp	●	●
CNGA-433 APS	CNGA-120412 APS	CBGAM3APS	1/2	1.19	4.75	5.16	Sharp	●	●
CNGA-431 AP 0420A	CNGA-120404 AP 0420A	CBGAM1AP0420A	1/2	0.38	4.75	5.16	T-Land W=0.10, Angle 20°	●	●
CNGA-432 AP 0420A	CNGA-120408 AP 0420A	CBGAM2AP0420A	1/2	0.79	4.75	5.16	T-Land W=0.10, Angle 20°	●	●
CNGA-433 AP 0420A	CNGA-120412 AP 0420A	CBGAM3AP0420A	1/2	1.19	4.75	5.16	T-Land W=0.10, Angle 20°	●	●
CNGA-431 AL 0420A	CNGA-120404 AP 0420A	CBGAM1AL0420A	1/2	0.38	4.75	5.16	T-Land W=0.10, Angle 20°	●	●
CNGA-432 AL 0420A	CNGA-120408 AP 0420A	CBGAM2AL0420A	1/2	0.79	4.75	5.16	T-Land W=0.10, Angle 20°	●	●
CNGA-433 AL 0420A	CNGA-120412 AP 0420A	CBGAM3AL0420A	1/2	1.19	4.75	5.16	T-Land W=0.10, Angle 20°	●	●

DOUBLE TIP PCBN

CNGA

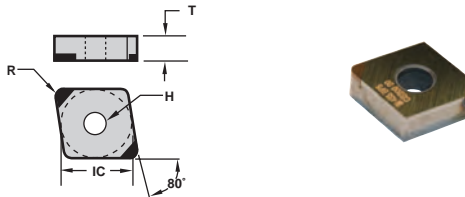

For Holders see pg. 184-204.

Description	ISO Description	EDP Code	IC	R	T	H	Wiper	Edge Prep	CB200	CB400
CNGA-431 BPS	CNGA-120404 BPS	CBGAM1BPS	1/2	0.38	4.75	5.16		Sharp	●	●
CNGA-432 BPS	CNGA-120408 BPS	CBGAM2BPS	1/2	0.79	4.75	5.16		Sharp	●	●
CNGA-433 BPS	CNGA-120412 BPS	CBGAM3BPS	1/2	1.19	4.75	5.16		Sharp	●	●
CNGA-431 BP 0420A	CNGA-120404 BP 0420A	CBGAM1BP0420A	1/2	0.38	4.75	5.16		T-Land W=0.10, Angle 20°	●	●
CNGA-432 BP 0420A	CNGA-120408 BP 0420A	CBGAM2BP0420A	1/2	0.79	4.75	5.16		T-Land W=0.10, Angle 20°	●	●
CNGA-433 BP 0420A	CNGA-120412 BP 0420A	CBGAM3BP0420A	1/2	1.19	4.75	5.16		T-Land W=0.10, Angle 20°	●	●
CNGA-431 WBP 0420A	CNGA-120404 WBP 0420A	CBGAM1WBP0420A	1/2	0.38	4.75	5.16	✓	T-Land W=0.10, Angle 20°	●	●
CNGA-432 WBP 0420A	CNGA-120408 WBP 0420A	CBGAM2WBP0420A	1/2	0.79	4.75	5.16	✓	T-Land W=0.10, Angle 20°	●	●
CNGA-433 WBP 0420A	CNGA-120412 WBP 0420A	GBGAM2WBP0420A	1/2	1.19	4.75	5.16	✓	T-Land W=0.10, Angle 20°	●	●

PCBN

SINGLE TIP PCBN

DNGA

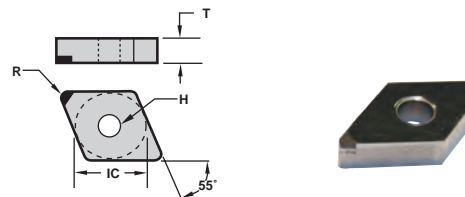

For Holders see pg. 184-204.

Description	ISO Description	EDP Code	IC	R	T	H	Edge Prep	CB200	CB400
DNGA-431 APS	DNGA-120404 APS	CEGAM1APS	1/2	0.38	4.75	5.16	Sharp	●	●
DNGA-432 APS	DNGA-120408 APS	CEGAM2APS	1/2	0.79	4.75	5.16	Sharp	●	●
DNGA-433 APS	DNGA-120412 APS	CEGAM3APS	1/2	1.19	4.75	5.16	Sharp	●	●
DNGA-431 AP 0420A	DNGA-120404 AP 0420A	CEGAM1AP0420A	1/2	0.38	4.75	5.16	T-Land W=0.10, Angle 20°	●	●
DNGA-432 AP 0420A	DNGA-120408 AP 0420A	CEGAM2AP0420A	1/2	0.79	4.75	5.16	T-Land W=0.10, Angle 20°	●	●
DNGA-433 AP 0420A	DNGA-120412 AP 0420A	CEGAM3AP0420A	1/2	1.19	4.75	5.16	T-Land W=0.10, Angle 20°	●	●
DNGA-431 AL 0420A	DNGA-120404 AL 0420A	CEGAM1AL0420A	1/2	0.38	4.75	5.16	T-Land W=0.10, Angle 20°	●	●
DNGA-432 AL 0420A	DNGA-120408 AL 0420A	CEGAM2AL0420A	1/2	0.79	4.75	5.16	T-Land W=0.10, Angle 20°	●	●
DNGA-433 AL 0420A	DNGA-120412 AL 0420A	CEGAM3AL0420A	1/2	1.19	4.75	5.16	T-Land W=0.10, Angle 20°	●	●

In an effort to improve our stock standard grade offering, there are periodic changes. Please see current price list for up to date grade offering.

- High performance choice in optimal conditions.
- ▲ Recommended grade under general conditions.

Cast Irons	●
Hardened & Bearing Steel	●
Powdered Metals	●
Super Alloys	●



DOUBLE TIP PCBN

DNGA

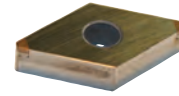
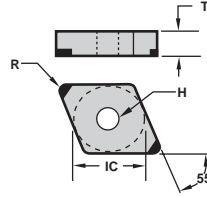

For Holders see pg. 184-204.

Description	ISO Description	EDP Code	IC	R	T	H	Wiper	Edge Prep	CB200	CB400
DNGA-431 BPS	DNGA-120404 BPS	CEGAM1BPS	1/2	0.38	4.75	5.16		Sharp	●	●
DNGA-432 BPS	DNGA-120408 BPS	CEGAM2BPS	1/2	0.79	4.75	5.16		Sharp	●	●
DNGA-433 BPS	DNGA-120412 BPS	CEGAM3BPS	1/2	1.19	4.75	5.16		Sharp	●	●
DNGA-431 BP 0420A	DNGA-120404 BP 0420A	CEGAM1BP0420A	1/2	0.38	4.75	5.16		T-Land W=0.10, Angle 20°	●	●
DNGA-432 BP 0420A	DNGA-120408 BP 0420A	CEGAM2BP0420A	1/2	0.79	4.75	5.16		T-Land W=0.10, Angle 20°	●	●
DNGA-433 BP 0420A	DNGA-120412 BP 0420A	CEGAM3BP0420A	1/2	1.19	4.75	5.16		T-Land W=0.10, Angle 20°	●	●
DNGA-431 WBP 0420A	DNGA-120404 WBP 0420A	CEGAM1WBP0420A	1/2	0.38	4.75	5.16	✓	T-Land W=0.10, Angle 20°	●	●
DNGA-432 WBP 0420A	DNGA-120408 WBP 0420A	CEGAM2WBP0420A	1/2	0.79	4.75	5.16	✓	T-Land W=0.10, Angle 20°	●	●
DNGA-433 WBP 0420A	DNGA-120412 WBP 0420A	CEGAM3WBP0420A	1/2	1.19	4.75	5.16	✓	T-Land W=0.10, Angle 20°	●	●

SINGLE TIP PCBN

SNGA

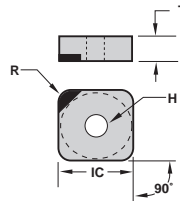

For Holders see pg. 184-204.

Description	ISO Description	EDP Code	IC	R	T	H	Edge Prep	CB200	CB400
SNGA-431 APS	SNGA-120404 APS	CNGAM1APS	1/2	0.38	4.75	5.16	Sharp	●	●
SNGA-432 APS	SNGA-120408 APS	CNGAM2APS	1/2	0.79	4.75	5.16	Sharp	●	●
SNGA-433 APS	SNGA-120412 APS	CNGAM3APS	1/2	1.19	4.75	5.16	Sharp	●	●
SNGA-431 AP 0420A	SNGA-120404 AP 0420A	CNGAM1AP0420A	1/2	0.38	4.75	5.16	T-Land W=0.10, Angle 20°	●	●
SNGA-432 AP 0420A	SNGA-120408 AP 0420A	CNGAM2AP0420A	1/2	0.79	4.75	5.16	T-Land W=0.10, Angle 20°	●	●
SNGA-433 AP 0420A	SNGA-120412 AP 0420A	CNGAM3AP0420A	1/2	1.19	4.75	5.16	T-Land W=0.10, Angle 20°	●	●
SNGA-431 AL 0420A	SNGA-120404 AL 0420A	CNGAM1AL0420A	1/2	0.38	4.75	5.16	T-Land W=0.10, Angle 20°	●	●
SNGA-432 AL 0420A	SNGA-120408 AL 0420A	CNGAM2AL0420A	1/2	0.79	4.75	5.16	T-Land W=0.10, Angle 20°	●	●
SNGA-433 AL 0420A	SNGA-120412 AL 0420A	CNGAM3AL0420A	1/2	1.19	4.75	5.16	T-Land W=0.10, Angle 20°	●	●

PCBN

DOUBLE TIP PCBN

SNGA

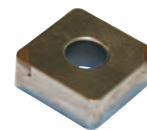
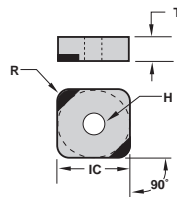

For Holders see pg. 184-204.

Description	ISO Description	EDP Code	IC	R	T	H	Wiper	Edge Prep	CB200	CB400
SNGA-431 BPS	SNGA-120404 BPS	CNGAM1BPS	1/2	0.38	4.75	5.16		Sharp	●	●
SNGA-432 BPS	SNGA-120408 BPS	CNGAM2BPS	1/2	0.79	4.75	5.16		Sharp	●	●
SNGA-433 BPS	SNGA-120412 BPS	CNGAM3BPS	1/2	1.19	4.75	5.16		Sharp	●	●
SNGA-431 BP 0420A	SNGA-120404 BP 0420A	CNGAM1BP0420A	1/2	0.38	4.75	5.16		T-Land W=0.10, Angle 20°	●	●
SNGA-432 BP 0420A	SNGA-120408 BP 0420A	CNGAM2BP0420A	1/2	0.79	4.75	5.16		T-Land W=0.10, Angle 20°	●	●
SNGA-433 BP 0420A	SNGA-120412 BP 0420A	CNGAM3BP0420A	1/2	1.19	4.75	5.16		T-Land W=0.10, Angle 20°	●	●
SNGA-431 WBP 0420A	SNGA-120404 WBP 0420A	CNGAM1WBP0420A	1/2	0.38	4.75	5.16	✓	T-Land W=0.10, Angle 20°	●	●
SNGA-432 WBP 0420A	SNGA-120408 WBP 0420A	CNGAM2WBP0420A	1/2	0.79	4.75	5.16	✓	T-Land W=0.10, Angle 20°	●	●
SNGA-433 WBP 0420A	SNGA-120412 WBP 0420A	CNGAM3WBP0420A	1/2	1.19	4.75	5.16	✓	T-Land W=0.10, Angle 20°	●	●

In an effort to improve our stock standard grade offering, there are periodic changes. Please see current price list for up to date grade offering.

- High performance choice in optimal conditions.
- ▲ Recommended grade under general conditions.

Cast Irons	●	●
Hardened & Bearing Steel	●	●
Powdered Metals	●	●
Super Alloys	●	●



SINGLE TIP PCBN

TNGA

For Holders see pg. 184-204.

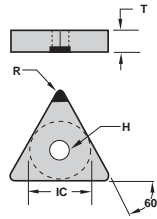

Description	EDP Code	IC	R	T	H	Edge Prep	CB200	CB400	
TNGA-331 APS	TNGA-331 APS	CTGAH1APS	3/8	0.38	4.75	3.81	Sharp	●	●
TNGA-332 APS	TNGA-331 APS	CTGAH2APS	3/8	0.79	4.75	3.81	Sharp	●	●
TNGA-333 APS	TNGA-331 APS	CTGAH3APS	3/8	1.19	4.75	3.81	Sharp	●	●
TNGA-331 AP 0420A	TNGA-331 AP 0420A	CTGAH1AP0420A	3/8	0.38	4.75	3.81	T-Land W=0.10, Angle 20°	●	●
TNGA-332 AP 0420A	TNGA-331 AP 0420A	CTGAH2AP0420A	3/8	0.79	4.75	3.81	T-Land W=0.10, Angle 20°	●	●
TNGA-333 AP 0420A	TNGA-331 AP 0420A	CTGAH3AP0420A	3/8	1.19	4.75	3.81	T-Land W=0.10, Angle 20°	●	●
TNGA-331 AL 0420A	TNGA-331 AL 0420A	CTGAH1AL0420A	3/8	0.38	4.75	3.81	T-Land W=0.10, Angle 20°	●	●
TNGA-332 AL 0420A	TNGA-331 AL 0420A	CTGAH2AL0420A	3/8	0.79	4.75	3.81	T-Land W=0.10, Angle 20°	●	●
TNGA-333 AL 0420A	TNGA-331 AL 0420A	CTGAH3AL0420A	3/8	1.19	4.75	3.81	T-Land W=0.10, Angle 20°	●	●
TNGA-431 APS	TNGA-431 APS	CTGAJ1APS	1/2	0.38	4.75	5.16	Sharp	●	●
TNGA-432 APS	TNGA-431 APS	CTGAJ2APS	1/2	0.79	4.75	5.16	Sharp	●	●
TNGA-433 APS	TNGA-431 APS	CTGAJ3APS	1/2	1.19	4.75	5.16	Sharp	●	●
TNGA-431 AP 0420A	TNGA-431 AP 0420A	CTGAJ1AP0420A	1/2	0.38	4.75	5.16	T-Land W=0.10, Angle 20°	●	●
TNGA-432 AP 0420A	TNGA-431 AP 0420A	CTGAJ2AP0420A	1/2	0.79	4.75	5.16	T-Land W=0.10, Angle 20°	●	●
TNGA-433 AP 0420A	TNGA-431 AP 0420A	CTGAJ3AP0420A	1/2	1.19	4.75	5.16	T-Land W=0.10, Angle 20°	●	●
TNGA-431 AL 0420A	TNGA-431 AL 0420A	CTGAJ1AL0420A	1/2	0.38	4.75	5.16	T-Land W=0.10, Angle 20°	●	●
TNGA-432 AL 0420A	TNGA-431 AL 0420A	CTGAJ2AL0420A	1/2	0.79	4.75	5.16	T-Land W=0.10, Angle 20°	●	●
TNGA-433 AL 0420A	TNGA-431 AL 0420A	CTGAJ3AL0420A	1/2	1.19	4.75	5.16	T-Land W=0.10, Angle 20°	●	●

TRIPLE TIP PCBN

TNGA

For Holders see pg. 184-204.

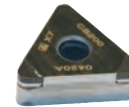
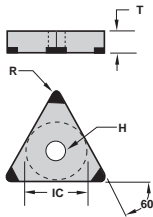

Description	EDP Code	IC	R	T	H	Wiper	Edge Prep	CB200	CB400
TNGA-331 CPS	CTGAH1CPS	3/8	0.38	4.75	3.81		Sharp	●	●
TNGA-332 CPS	CTGAH2CPS	3/8	0.79	4.75	3.81		Sharp	●	●
TNGA-333 CPS	CTGAH3CPS	3/8	1.19	4.75	3.81		Sharp	●	●
TNGA-331 CP 0420A	CTGAH1CP0420A	3/8	0.38	4.75	3.81		T-Land W=0.10, Angle 20°	●	●
TNGA-332 CP 0420A	CTGAH2CP0420A	3/8	0.79	4.75	3.81		T-Land W=0.10, Angle 20°	●	●
TNGA-333 CP 0420A	CTGAH3CP0420A	3/8	1.19	4.75	3.81		T-Land W=0.10, Angle 20°	●	●
TNGA-331 WCP 0420A	CTGAH1WCP0420A	3/8	0.38	4.75	3.81	✓	T-Land W=0.10, Angle 20°	●	●
TNGA-332 WCP 0420A	CTGAH2WCP0420A	3/8	0.79	4.75	3.81	✓	T-Land W=0.10, Angle 20°	●	●
TNGA-333 WCP 0420A	CTGAH3WCP0420A	3/8	1.19	4.75	3.81	✓	T-Land W=0.10, Angle 20°	●	●
TNGA-431 CPS	CTGAJ1CPS	1/2	0.38	4.75	5.16		Sharp	●	●
TNGA-432 CPS	CTGAJ2CPS	1/2	0.79	4.75	5.16		Sharp	●	●
TNGA-433 CPS	CTGAJ3CPS	1/2	1.19	4.75	5.16		Sharp	●	●
TNGA-431 CP 0420A	CTGAJ1CP0420A	1/2	0.38	4.75	5.16		T-Land W=0.10, Angle 20°	●	●
TNGA-432 CP 0420A	CTGAJ2CP0420A	1/2	0.79	4.75	5.16		T-Land W=0.10, Angle 20°	●	●
TNGA-433 CP 0420A	CTGAJ3CP0420A	1/2	1.19	4.75	5.16		T-Land W=0.10, Angle 20°	●	●
TNGA-431 WCP 0420A	CTGAJ1WCP0420A	1/2	0.38	4.75	5.16	✓	T-Land W=0.10, Angle 20°	●	●
TNGA-432 WCP 0420A	CTGAJ2WCP0420A	1/2	0.79	4.75	5.16	✓	T-Land W=0.10, Angle 20°	●	●
TNGA-433 WCP 0420A	CTGAJ3WCP0420A	1/2	1.19	4.75	5.16	✓	T-Land W=0.10, Angle 20°	●	●

In an effort to improve our stock standard grade offering, there are periodic changes. Please see current price list for up to date grade offering.

- High performance choice in optimal conditions.
- ▲ Recommended grade under general conditions.

Cast Irons	●	
Hardened & Bearing Steel		●
Powdered Metals	●	
Super Alloys	●	



SINGLE TIP PCBN

VNGA

For Holders see pg. 184-204.

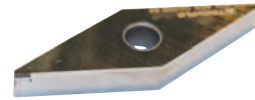
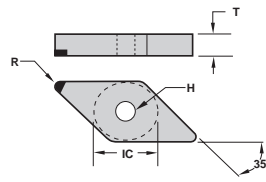

Description	EDP Code	IC	R	T	H	Edge Prep	CB200	CB400
VNGA-331 APS	CXGAH1APS	3/8	0.38	4.75	3.81	Sharp	●	●
VNGA-332 APS	CXGAH2APS	3/8	0.79	4.75	3.81	Sharp	●	●
VNGA-333 APS	CXGAH3APS	3/8	1.19	4.75	3.81	Sharp	●	●
VNGA-331 AP 0420A	CXGAH1AP0420A	3/8	0.38	4.75	3.81	T-Land W=0.10, Angle 20°	●	●
VNGA-332 AP 0420A	CXGAH2AP0420A	3/8	0.79	4.75	3.81	T-Land W=0.10, Angle 20°	●	●
VNGA-333 AP 0420A	CXGAH3AP0420A	3/8	1.19	4.75	3.81	T-Land W=0.10, Angle 20°	●	●
VNGA-331 AL 0420A	CXGAH1AL0420A	3/8	0.38	4.75	3.81	T-Land W=0.10, Angle 20°	●	●
VNGA-332 AL 0420A	CXGAH2AL0420A	3/8	0.79	4.75	3.81	T-Land W=0.10, Angle 20°	●	●
VNGA-333 AL 0420A	CXGAH3AL0420A	3/8	1.19	4.75	3.81	T-Land W=0.10, Angle 20°	●	●
VNGA-431 APS	CXGAJ1APS	1/2	0.38	4.75	5.16	Sharp	●	●
VNGA-432 APS	CXGAJ2APS	1/2	0.79	4.75	5.16	Sharp	●	●
VNGA-433 APS	CXGAJ3APS	1/2	1.19	4.75	5.16	Sharp	●	●
VNGA-431 AP 0420A	CXGAJ1AP0420A	1/2	0.38	4.75	5.16	T-Land W=0.10, Angle 20°	●	●
VNGA-432 AP 0420A	CXGAJ2AP0420A	1/2	0.79	4.75	5.16	T-Land W=0.10, Angle 20°	●	●
VNGA-433 AP 0420A	CXGAJ3AP0420A	1/2	1.19	4.75	5.16	T-Land W=0.10, Angle 20°	●	●
VNGA-431 AL 0420A	CXGAJ1AL0420A	1/2	0.38	4.75	5.16	T-Land W=0.10, Angle 20°	●	●
VNGA-432 AL 0420A	CXGAJ2AL0420A	1/2	0.79	4.75	5.16	T-Land W=0.10, Angle 20°	●	●
VNGA-433 AL 0420A	CXGAJ3AL0420A	1/2	1.19	4.75	5.16	T-Land W=0.10, Angle 20°	●	●

DOUBLE TIP PCBN

VNGA

For Holders see pg. 184-204.

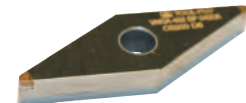
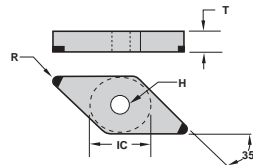

Description	EDP Code	IC	R	T	H	Wiper	Edge Prep	CB200	CB400
VNGA-331 BPS	CXGAH1BPS	3/8	0.38	4.75	3.81		Sharp	●	●
VNGA-332 BPS	CXGAH2BPS	3/8	0.79	4.75	3.81		Sharp	●	●
VNGA-331 BP 0420A	CXGAH1BP0420A	3/8	0.38	4.75	3.81		T-Land W=0.10, Angle 20°	●	●
VNGA-332 BP 0420A	CXGAH2BP0420A	3/8	0.79	4.75	3.81		T-Land W=0.10, Angle 20°	●	●
VNGA-333 BP 0420A	CXGAH3BP0420A	3/8	1.19	4.75	3.81		T-Land W=0.10, Angle 20°	●	●
VNGA-331 WBP 0420A	CXGAH1WBP0420A	3/8	0.38	4.75	3.81	✓	T-Land W=0.10, Angle 20°	●	●
VNGA-332 WBP 0420A	CXGAH2WBP0420A	3/8	0.79	4.75	3.81	✓	T-Land W=0.10, Angle 20°	●	●
VNGA-333 WBP 0420A	CXGAH3WBP0420A	3/8	1.19	4.75	3.81	✓	T-Land W=0.10, Angle 20°	●	●
VNGA-431 BPS	CXGAJ1BPS	1/2	0.38	4.75	5.16		Sharp	●	●
VNGA-432 BPS	CXGAJ2BPS	1/2	0.79	4.75	5.16		Sharp	●	●
VNGA-433 BPS	CXGAJ3BPS	1/2	1.19	4.75	5.16		Sharp	●	●
VNGA-431 BP 0420A	CXGAJ1BP0420A	1/2	0.38	4.75	5.16		T-Land W=0.10, Angle 20°	●	●
VNGA-432 BP 0420A	CXGAJ2BP0420A	1/2	0.79	4.75	5.16		T-Land W=0.10, Angle 20°	●	●
VNGA-433 BP 0420A	CXGAJ3BP0420A	1/2	1.19	4.75	5.16		T-Land W=0.10, Angle 20°	●	●
VNGA-431 WBP 0420A	CXGAJ1WBP0420A	1/2	0.38	4.75	5.16	✓	T-Land W=0.10, Angle 20°	●	●
VNGA-432 WBP 0420A	CXGAJ2WBP0420A	1/2	0.79	4.75	5.16	✓	T-Land W=0.10, Angle 20°	●	●
VNGA-433 WBP 0420A	CXGAJ3WBP0420A	1/2	1.19	4.75	5.16	✓	T-Land W=0.10, Angle 20°	●	●

In an effort to improve our stock standard grade offering, there are periodic changes. Please see current price list for up to date grade offering.

- High performance choice in optimal conditions.
- ▲ Recommended grade under general conditions.

Cast Irons	●
Hardened & Bearing Steel	●
Powdered Metals	●
Super Alloys	●



PCBN

SINGLE TIP PCBN GROOVING

FLG

For Holders see pg. 101-104.

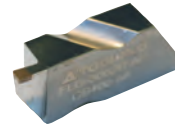
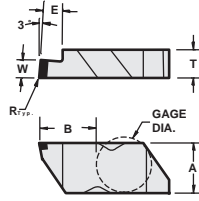

Description	EDP Code	W	R	T	H	E	Edge Prep	CB200	CB400	
FLG-3047L APB	CB563647LAPB	1.19	0.13	0.25	4.95	5.56	1.91	0.03 Hone	●	●
FLG-3047R APB	CB563647RAPB	1.19	0.13	0.25	4.95	5.56	1.91	0.03 Hone	●	●
FLG-3062L APB	CB563662LAPB	1.57	0.13	0.25	4.95	5.56	3.05	0.03 Hone	●	●
FLG-3062R APB	CB563662RAPB	1.57	0.13	0.25	4.95	5.56	3.05	0.03 Hone	●	●
FLG-3094L AMB	CB563694LAMB	2.39	0.13	0.25	4.95	5.56	4.57	0.03 Hone	●	●
FLG-3094R AMB	CB563694RAMB	2.39	0.13	0.25	4.95	5.56	4.57	0.03 Hone	●	●
FLG-3125L AMB	CB563825LAMB	3.18	0.13	0.25	4.95	5.56	4.57	0.03 Hone	●	●
FLG-3125R AMB	CB563825RAMB	3.18	0.13	0.25	4.95	5.56	4.57	0.03 Hone	●	●
FLG-3189L ALB	CB563889LALB	4.80	0.51	0.64	4.95	5.56	4.57	0.03 Hone	●	●
FLG-3189R ALB	CB563889RALB	4.80	0.51	0.64	4.95	5.56	4.57	0.03 Hone	●	●
FLG-4250L ALB	CB574050LALB	6.35	0.51	0.64	6.48	11.51	6.35	0.03 Hone	●	●
FLG-4250R ALB	CB574050RALB	6.35	0.51	0.64	6.48	11.51	6.35	0.03 Hone	●	●

SINGLE TIP PCBN GROOVING

FLR

Full Nose Radius

For Holders see pg.101-104.

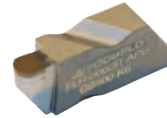
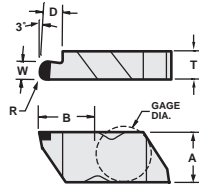

Description	EDP Code	W	R	T	H	E	Edge Prep	CB200	CB400	
FLR-3031L APB	CB593031LAPB	1.57	0.79	0.79	4.95	5.56	3.18	0.03 Hone	●	●
FLR-3031R APB	CB593031RAPB	1.57	0.79	0.79	4.95	5.56	3.18	0.03 Hone	●	●
FLR-3062L APB	CB593062LAPB	3.18	1.57	1.57	4.95	5.56	4.57	0.03 Hone	●	●
FLR-3062R APB	CB593062RAPB	3.18	1.57	1.57	4.95	5.56	4.57	0.03 Hone	●	●

PCBN

SINGLE TIP PCBN GROOVING

VDB

For Holders see pg. 213-214

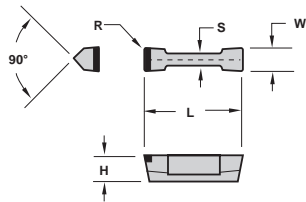

Description	EDP Code	W	R	L	H	S	Edge Prep	CB200	CB400	
VDB 125 A015 AMB	CB79125AMB	3.18	0.38	0.38	28.58	6.35	2.69	0.03 Hone	●	●
VDB 188 A015 ALB	CB79188ALB	4.78	0.38	0.38	28.58	6.35	3.66	0.03 Hone	●	●
VDB 250 A015 ALB	CB79250ALB	6.35	0.38	0.38	28.58	6.35	3.66	0.03 Hone	●	●

In an effort to improve our stock standard grade offering, there are periodic changes. Please see current price list for up to date grade offering.

- High performance choice in optimal conditions.
- ▲ Recommended grade under general conditions.

Cast Irons	●	●
Hardened & Bearing Steel	●	●
Powdered Metals	●	●
Super Alloys	●	●

Recommended Feed rate - m/rev

workpiece material	hardened steels	grey cast irons	white alloy cast iron	super alloys	powdered metal	bearing steels
CB200 <i>high content CBN for finishing</i>		0.25 - 0.51	0.25 - 0.76	0.08 - 0.20	0.08 - 0.20	
CB400 <i>low content CBN for roughing</i>	0.10 - 0.20					0.05 - 0.20

Recommended Grade and Speed - m/min

workpiece material	hardened steels	grey cast irons	white alloy cast iron	super alloys	powdered metal	bearing steels
CB200 <i>high content CBN for finishing</i>		< 240 HBN 457 - 1067 > 240 HBN 305 - 610	91 - 200	152 - 305	91 - 305	
CB400 <i>low content CBN for roughing</i>	122 - 152					114 - 152

Recommended Edge Preparation

The following are suggestions for standard edge preparations.

Turning	CB200	0.203 x 20° and/or 0.025 hone
Grooving (Flo-Lock and Vee-Bottom)	CB400	0.102 x 20° and/or 0.025 hone

Due to unique applications, special edge preparations may be required.

T-Land and hones protect the cutting edge by eliminating a sharp cutting edge which reduces edge chipping and breakage. Up-sharp edges are prone to chipping or breakage.

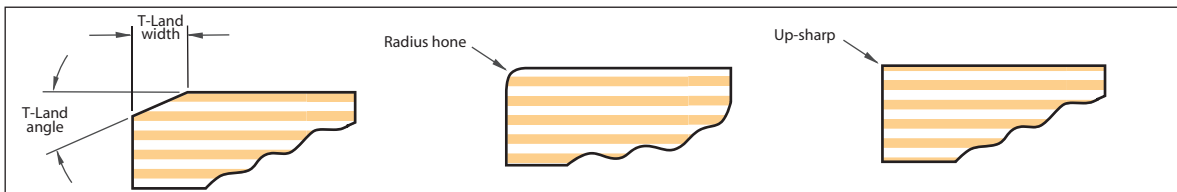

T-Land and hones strengthen the cutting edges by redirecting the cutting forces back into the insert.

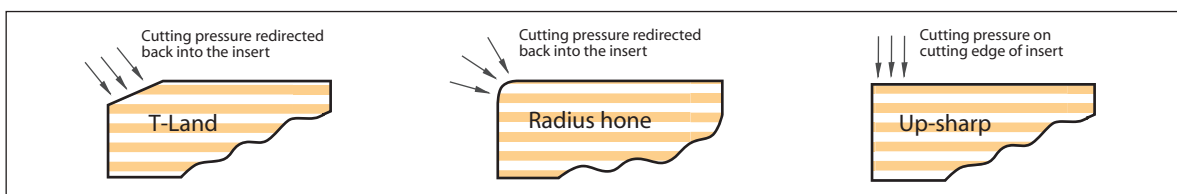

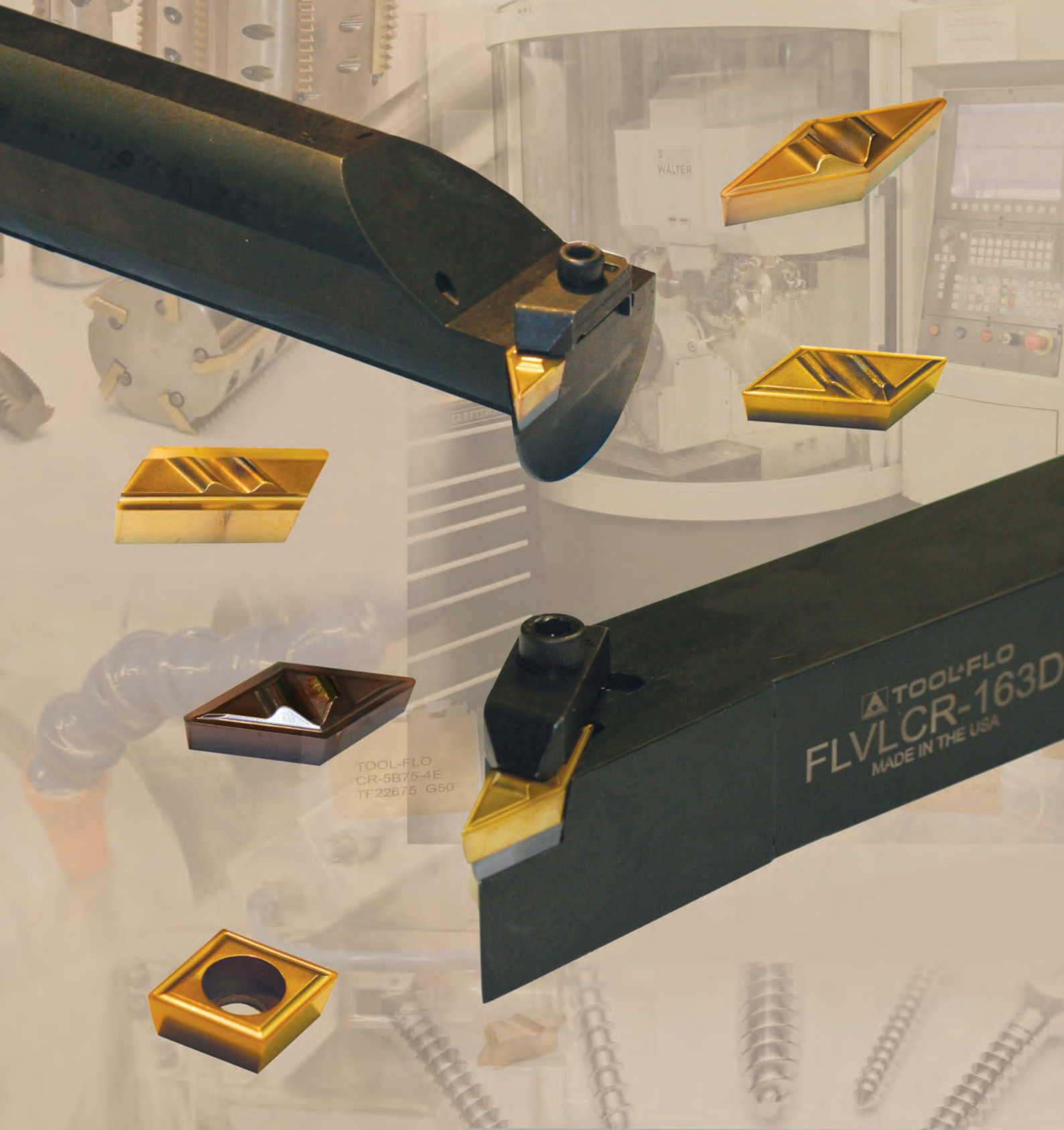

PROFILING



BORING SMALL DIAMETER

CPGM

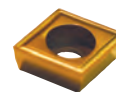
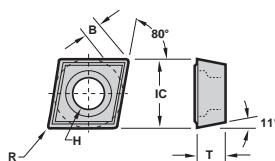

Description	EDP Code	IC	R	T	B	H	TIN Coated		A/TIN Coated	
							GP25	GP50	AC25	AC50
CPGM-21.50	SA20	1/4	0.10	2.39	1.71	2.79	●	●	●	●
CPGM-21.505	SA205	1/4	0.20	2.39	1.65	2.79	●	●	●	●
CPGM-21.51	SA21	1/4	0.38	2.39	1.54	2.79	●	●	●	●
CPGM-21.52	SA22	1/4	0.79	2.39	1.32	2.79	●	●	●	●
CPGM-32.50	SA30	3/8	0.10	3.96	2.59	4.39	●	●	●	●
CPGM-32.505	SA305	3/8	0.20	3.96	2.53	4.39	●	●	●	●
CPGM-32.51	SA31	3/8	0.38	3.96	2.17	4.39	●	●	●	●
CPGM-32.52	SA32	3/8	0.79	3.96	2.20	4.39	●	●	●	●

55° DIAMOND PROFILING

DPGR

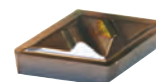
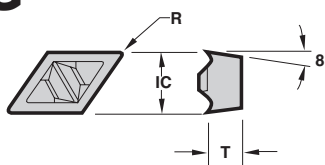

Description	EDP Code	D	T	R	TIN Coated		A/TIN Coated	
					GP25	GP50	AC25	AC50
DPGR-432	643432	12.70	4.75	0.79	●	●	●	●

55° PARALLELOGRAM PROFILING

FLPGL/R

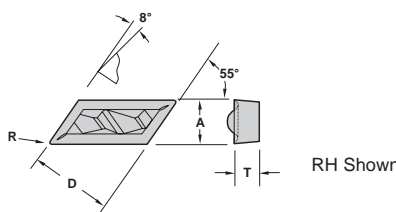

Description	EDP Code	D	T	A	R	TIN Coated		A/TIN Coated	
						GP25	GP50	AC25	AC50
FLPGL-51	641G51	9.53	3.18	6.35	0.38	●	●	●	●
FLPGR-51	642G51	9.53	3.18	6.35	0.38	●	●	●	●
FLPGL-52	641G52	9.53	3.18	6.35	0.79	●	●	●	●
FLPGR-52	642G52	9.53	3.18	6.35	0.79	●	●	●	●

PROFILING

FLPL/R

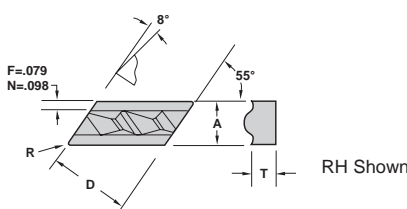
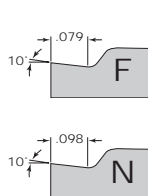

Description	EDP Code	R	T	D	A	TIN Coated		A/TIN Coated	
						GP25	GP50	AC25	AC50
FLPR-50.5	642505	0.13	3.18	9.53	6.35	●	●	●	●
FLPL-50.5	641505	0.13	3.18	9.53	6.35	●	●	●	●
FLPR-51	64251	0.38	3.18	9.53	6.35	●	●	●	●
FLPL-51	64151	0.38	3.18	9.53	6.35	●	●	●	●
FLPR-52	64252	0.79	3.18	9.53	6.35	●	●	●	●
FLPL-52	64152	0.79	3.18	9.53	6.35	●	●	●	●
FLPR-130.5	6421305	0.13	4.75	12.70	9.53	●	●	●	●
FLPL-130.5	6411305	0.13	4.75	12.70	9.53	●	●	●	●
FLPR-131F	642131F	0.38	4.75	12.70	9.53	●	●	●	●
FLPL-131F	641131F	0.38	4.75	12.70	9.53	●	●	●	●
FLPR-132F	642132F	0.79	4.75	12.70	9.53	●	●	●	●
FLPL-132F	641132F	0.79	4.75	12.70	9.53	●	●	●	●
FLPR-132N	642132N	0.79	4.75	12.70	9.53	●	●	●	●
FLPL-132N	641132N	0.79	4.75	12.70	9.53	●	●	●	●
FLPR-331N	642331N	0.38	4.75	18.64	9.53	●	●	●	●
FLPL-331N	641331N	0.38	4.75	18.64	9.53	●	●	●	●
FLPR-332F	642332F	0.79	4.75	18.64	9.53	●	●	●	●
FLPL-332F	641332F	0.79	4.75	18.64	9.53	●	●	●	●
FLPR-332N	642332N	0.79	4.75	18.64	9.53	●	●	●	●
FLPL-332N	641332N	0.79	4.75	18.64	9.53	●	●	●	●

In an effort to improve our stock standard grade offering, there are periodic changes. Please see current price list for up to date grade offering.

● High performance choice in optimal conditions.
▲ Recommended grade under general conditions.

Cast Iron	▲	●		
Non-Ferrous	▲	●		
Stainless/High Temp	▲	●		
Steel	▲		●	



PROFILING

35° DIAMOND PROFILING

VPGR

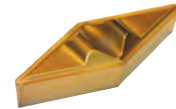
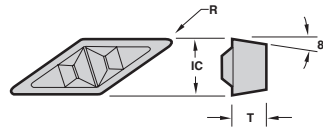

Description	EDP Code	IC	T	R	TIN Coated		ATTN Coated	
					GP25	GP50	AC25	AC50
VPGR-330.5	6443305	3/8	4.75	0.20	●	●	●	●
VPGR-331	644331	3/8	4.75	0.38	●	●	●	●
VPGR-332	644332	3/8	4.75	0.79	●	●	●	●

In an effort to improve our stock standard grade offering, there are periodic changes. Please see current price list for up to date grade offering.

● High performance choice in optimal conditions.
▲ Recommended grade under general conditions.

Cast Iron	▲	●		
Non-Ferrous				
Stainless/High Temp	▲		●	
Steel		▲		●

EXTERNAL HOLDERS

FLDLPR/L
Profiling

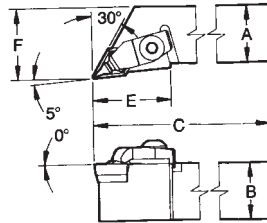

RH SHOWN

PARTS

Description	EDP Code	Insert	A	B	C	E	F	Seat	Seat			Clamp
									Screw	Clamp	Screw	SBM-532
FLDLPR-2525M4D		928325M25	DPGR-432	25.00	25.00	150.00	35.05	31.75	SM-414	S-111	CM116	SBM-532
FLDLPL-2525M4D		928225M25	DPGR-432	25.00	25.00	150.00	35.05	31.75	SM-414	S-111	CM117	SBM-532
FLDLPR-3232M4D		928332M25	DPGR-432	32.00	32.00	150.00	35.05	38.10	SM-414	S-111	CM116	SBM-532
FLDLPL-3232M4D		928232M25	DPGR-432	32.00	32.00	150.00	35.05	38.10	SM-414	S-111	CM117	SBM-532

FLVLCR/L
Profiling

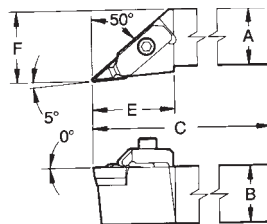

RH SHOWN

PARTS

Description	EDP Code	Insert	A	B	C	E	F	Seat	Seat			Clamp
									Screw	Clamp	Screw	SSM51
FLVLCR-2020M3B		935320M26	VPGR-33	20.00	20.00	125.00	36.58	25.40	SM-412	S-959	CM113	SSM51
FLVLCL-2020M3B		935220M26	VPGR-33	20.00	20.00	125.00	36.58	25.40	SM-412	S-959	CM114	SSM51
FLVLCR-2525M3D		935325M26	VPGR-33	25.00	25.00	150.00	36.58	31.75	SM-412	S-959	CM113	SSM51
FLVLCL-2525M3D		935225M26	VPGR-33	25.00	25.00	150.00	36.58	31.75	SM-412	S-959	CM114	SSM51
FLVLCR-3232M3D		935332M26	VPGR-33	32.00	32.00	150.00	36.58	38.10	SM-412	S-959	CM113	SSM51
FLVLCL-3232M3D		935232M26	VPGR-33	32.00	32.00	150.00	36.58	38.10	SM-412	S-959	CM114	SSM51

PROFILING



EXTERNAL HOLDERS

FLVVCN Profiling

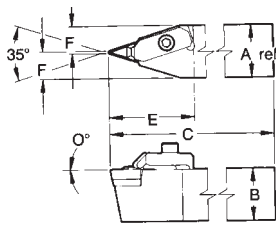

PARTS

Description	EDP Code	Insert	A	B	C	E	F	Seat	Seat Clamp			Clamp
									Screw	Screw	Screw	
FLVVCN-25M3D		935425M26	VPGR-33_	25	25	150	41.15	13.26	SM-412	S-959	CM113	SSM51
FLVVCN-32M3D		935432M26	VPGR-33_	32	32	170	41.15	16.43	SM-412	S-959	CM113	SSM51

FLDPPN Profiling

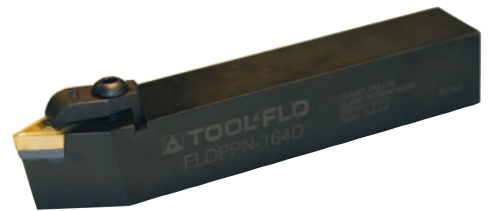
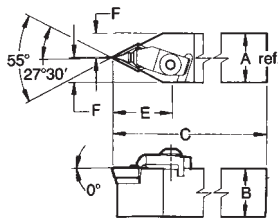

PARTS

Description	EDP Code	Insert	A	B	C	E	F	Seat	Seat Clamp			Clamp
									Screw	Screw	Screw	
FLDPPN-25M4D		928425M25	DPGR-432	25	25	150	40.39	13.18	SM-414	S-111	CM116	SBM-532
FLDPPN-32M4D		928432M25	DPGR-432	32	32	170	40.39	16.36	SM-414	S-111	CM116	SBM-532

FLKL Profiling

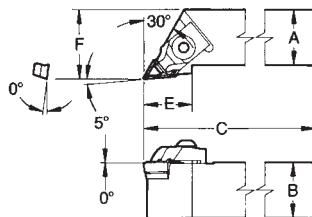

PARTS

Description	EDP Code	Insert	A	B	C	F	E	Seat	Seat Clamp			Clamp
									Screw	Screw	Screw	
FLKLCR-12M05V		931312M29	FLPR-5_*	12	12	80	19.05	22.23	SM-285	S-959	CM79	SBM-524
FLKLCL-12M05V		931212M29	FLPL-5_*	12	12	80	19.05	22.23	SM-286	S-959	CM71	SBM-524
FLKLCR-20M05B		931320M29	FLPR-5_*	20	20	125	25.40	22.23	SM-285	S-959	CM68	SBM-524
FLKLCL-20M05B		931220M29	FLPL-5_*	20	20	125	25.40	22.23	SM-286	S-959	CM68	SBM-524
FLKLNLR-20M1B		931320M30	FLPR-13_	20	20	125	25.40	31.75	SM-272	SL-344	CM66	SBM-625
FLKLNL-20M1B		931220M30	FLPL-13_	20	20	125	25.40	31.75	SM-271	SL-344	CM66	SBM-625
FLKLNLR-25M1C		931325M30	FLPR-13_	25	25	150	19.05	22.23	SM-272	SL-344	CM66	SBM-625
FLKLNL-25M1C		931225M30	FLPL-13_	25	25	150	19.05	22.23	SM-271	SL-344	CM66	SBM-625
FLKLNLR-25M3D		931325M31	FLPR-33_	25	25	150	38.10	22.23	SM-268	SL-344	CM65	SBM-625
FLKLNL-25M3D		931225M31	FLPL-33_	25	25	150	38.10	22.23	SM-267	SL-344	CM65	SBM-625
FLKLNLR-32M3D		931332M31	FLPR-33_	32	32	170	38.10	36.53	SM-268	SL-344	CM65	SBM-625
FLKLNL-32M3D		931232M31	FLPL-33_	32	32	170	38.10	36.53	SM-267	SL-344	CM65	SBM-625

*Also used with inserts FLPR/FLPL.



PROFILING

EXTERNAL HOLDERS

FLKL-F
Profiling

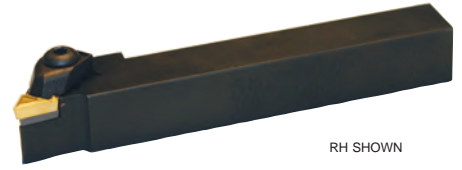
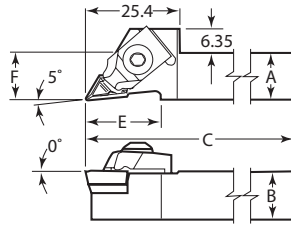

PARTS

Description	EDP Code	Insert	A	B	C	E	F	Seat	Seat Clamp			
									Screw	Clamp	Screw	
FLKLCRF-12M05D		931512M29	FLPR-5_*	12	12	150	19.05	12.70	SM-285	S-959	CM180	SBM-524
FLKLCLF-12M05D		931412M29	FLPL-5_*	12	12	150	19.05	12.70	SM-286	S-959	CM181	SBM-524
FLKLCRF-16M05B		931516M29	FLPR-5_*	16	16	100	19.05	15.88	SM-285	S-959	CM180	SBM-524
FLKLCLF-16M05B		931416M29	FLPL-5_*	16	16	100	19.05	15.88	SM-286	S-959	CM181	SBM-524

*Also used with inserts FLPGR/FLPGL.

FLKPCN
Profiling

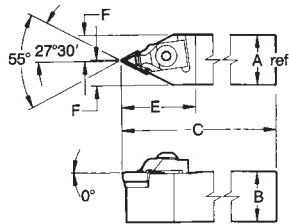

PARTS

Description	EDP Code	Insert	A	B	C	E	F	Seat	Seat Clamp			
									Screw	Clamp	Screw	
FLKPCN-12M05V		931612M29V	FLPR-5_*	12	12	80	28.58	6.60	SM-285	S-959	CM79	SBM-524
FLKPCN-12M05D		931612M29D	FLPR-5_*	12	12	150	28.58	6.60	SM-285	S-959	CM79	SBM-524
FLKPCN-20M05B		931620M29	FLPR-5_*	20	20	125	28.58	9.78	SM-285	S-959	CM68	SBM-524

*Also used with inserts FLPGR/FLPGL.

INTERNAL BARS

A-FLDL
Profiling

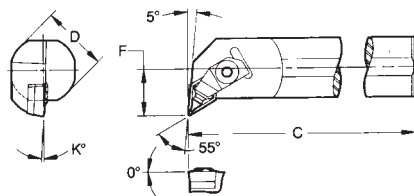

PARTS

Description	EDP Code	Insert	D	C	F	K°	Bore	Min. Seat	Seat Clamp			
									Screw	Clamp	Screw	
A32M-FLDLPR4		905232M25	DPGR-432	32	350	22.23	3°	40.26	SM-414	S-111	CM118	SBM-532
A32M-FLDLPL4		905032M25	DPGR-432	32	350	22.23	3°	40.26	SM-414	S-111	CM119	SBM-532
A40M-FLDLPR4		905240M25	DPGR-432	40	350	25.40	2°	46.61	SM-414	S-111	CM118	SBM-532
A40M-FLDLPL4		905040M25	DPGR-432	40	350	25.40	2°	46.61	SM-414	S-111	CM119	SBM-532
A44M-FLDLPR4		905244M25	DPGR-432	44	350	28.58	2°	53.85	SM-414	S-111	CM118	SBM-532
A44M-FLDLPL4		905044M25	DPGR-432	44	350	28.58	2°	53.85	SM-414	S-111	CM119	SBM-532
A50M-FLDLPR4		905250M25	DPGR-432	50	400	31.75	2°	60.96	SM-414	S-111	CM118	SBM-532
A50M-FLDLPL4		905050M25	DPGR-432	50	400	31.75	2°	60.96	SM-414	S-111	CM119	SBM-532

PROFILING



INTERNAL BARS

A-FLKL Profiling

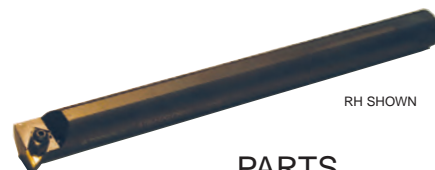
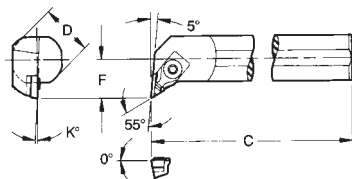

PARTS

Description	EDP Code	Insert	D	C	F	K°	Bore	Min. Seat	Clamp			
									Screw	Seat Clamp	Screw	Clamp
A16M-FLKLCR05		905616M29	FLPL-5_*	16	250	12.70	5°	22.86	SM-286	S-959	CM79	SBM-524
A16M-FLKLCL05		905416M29	FLPR-5_*	16	250	12.70	5°	22.86	SM-285	S-959	CM71	SBM-524
A20M-FLKLCR05		905620M29	FLPL-5_*	20	250	14.27	5°	24.89	SM-286	S-959	CM79	SBM-524
A20M-FLKLCL05		905420M29	FLPR-5_*	20	250	14.27	5°	24.89	SM-285	S-959	CM71	SBM-524
A25M-FLKLCR05		905625M29	FLPL-5_*	25	300	19.05	3°	33.02	SM-286	S-959	CM68	SBM-524
A25M-FLKLCL05		905425M29	FLPR-5_*	25	300	19.05	3°	33.02	SM-285	S-959	CM68	SBM-524
A32M-FLKLCR05		905632M29	FLPL-5_*	32	350	22.23	3°	40.26	SM-286	S-959	CM68	SBM-524
A32M-FLKLCL05		905432M29	FLPR-5_*	32	350	22.23	3°	40.26	SM-285	S-959	CM68	SBM-524
A40M-FLKLCR05		905640M29	FLPL-5_*	40	350	25.40	2°	46.61	SM-286	S-959	CM68	SBM-524
A40M-FLKLCL05		905440M29	FLPR-5_*	40	350	25.40	2°	46.61	SM-285	S-959	CM68	SBM-524
A50M-FLKLCR05		905650M29	FLPL-5_*	50	400	31.75	2°	60.96	SM-286	S-959	CM68	SBM-524
A50M-FLKLCL05		905450M29	FLPR-5_*	50	400	31.75	2°	60.96	SM-285	S-959	CM68	SBM-524

*Also used with inserts FLPR/FLPGL.

A-FLKQ Profiling

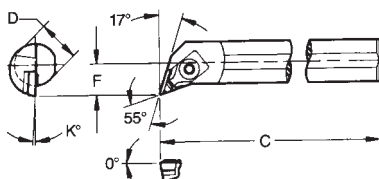

PARTS

Description	EDP Code	Insert	D	C	F	K°	Bore	Min. Seat	Clamp			
									Screw	Seat Clamp	Screw	Clamp
A12M-FLKQCR05		906012M29	FLPL-5_*	12	200	9.53	6°	17.02	-	-	CM112	SBM-518
A12M-FLKQCL05		905812M29	FLPR-5_*	12	200	9.53	6°	17.02	-	-	CM111	SBM-518
A20M-FLKQCR05		906020M29	FLPL-5_*	20	250	14.27	6°	24.89	SM-286	S-959	CM68	SBM-524
A20M-FLKQCL05		905820M29	FLPR-5_*	20	250	14.27	6°	24.89	SM-285	S-959	CM68	SBM-524
A25M-FLKQCR05		906025M29	FLPL-5_*	25	300	19.05	3°	33.02	SM-286	S-959	CM68	SBM-524
A25M-FLKQCL05		905825M29	FLPR-5_*	25	300	19.05	3°	33.02	SM-285	S-959	CM68	SBM-524

*Also used with inserts FLPR/FLPGL.

A-FLKX Profiling

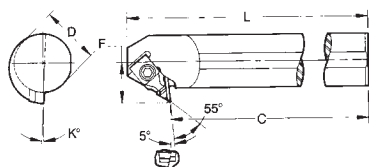

PARTS

Description	EDP Code	Insert	D	C	L	F	K°	Bore	Min. Seat	Clamp			
										Screw	Seat Clamp	Screw	Clamp
A20M-FLKXCR05		906420M29	FLPR-5_*	20	250	271.78	15.88	5°	26.92	SM-285	S-959	CM79	SBM-524
A20M-FLKXCL05		906220M29	FLPL-5_*	20	250	271.78	15.88	5°	26.92	SM-286	S-959	CM71	SBM-524
A25M-FLKXCR05		906425M29	FLPR-5_*	25	300	322.58	19.05	5°	33.02	SM-285	S-959	CM79	SBM-524
A25M-FLKXCL05		906225M29	FLPL-5_*	25	300	322.58	19.05	5°	33.02	SM-286	S-959	CM71	SBM-524

*Also used with inserts FLPR/FLPGL.

A-FLVL Profiling

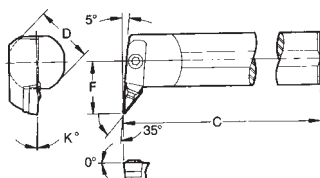

PARTS

Description	EDP Code	Insert	D	C	F	K°	Bore	Min. Seat	Clamp			
									Screw	Seat Clamp	Screw	Clamp
A20-FLVLCR3		90682026	VPGR-33_	32	350	28.58	2°	46.48	SM-412	S-959	CM113	SBM-412
A20-FLVLCL3		90662026	VPGR-33_	32	350	28.58	2°	46.48	SM-412	S-959	CM114	SBM-412
A24-FLVLCR3		90682426	VPGR-33_	40	350	31.75	2°	53.85	SM-412	S-959	CM113	SBM-412
A24-FLVLCL3		90662426	VPGR-33_	40	350	31.75	2°	53.85	SM-412	S-959	CM114	SBM-412
A32-FLVLCR3		90683226	VPGR-33_	50	400	38.10	2°	66.55	SM-412	S-959	CM113	SBM-412
A32-FLVLCL3		90663226	VPGR-33_	50	400	38.10	2°	66.55	SM-412	S-959	CM114	SBM-412

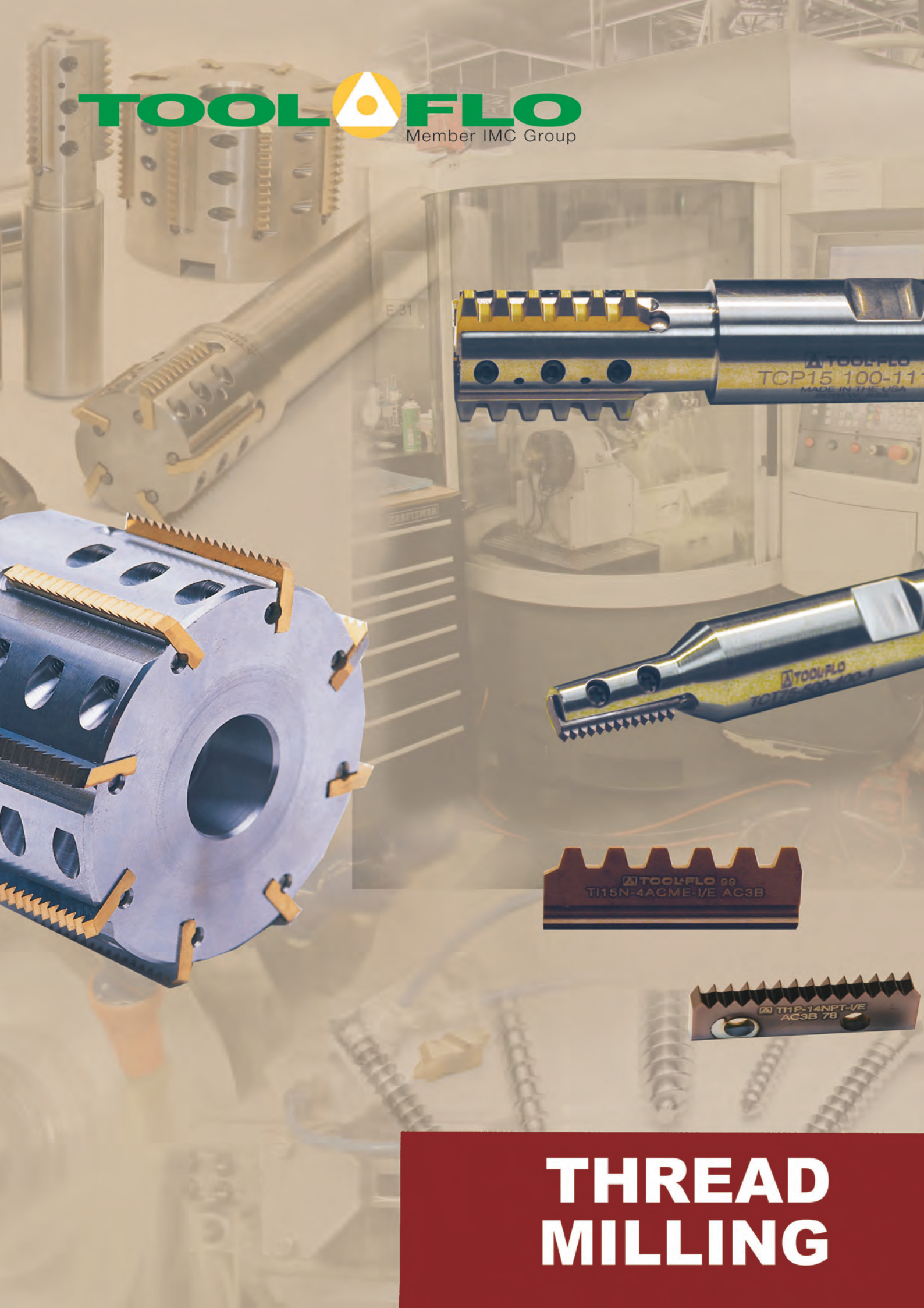

**THREAD
MILLING**

TC SERIES THREADMILLING



Threadmilling Insert Nomenclature Chart

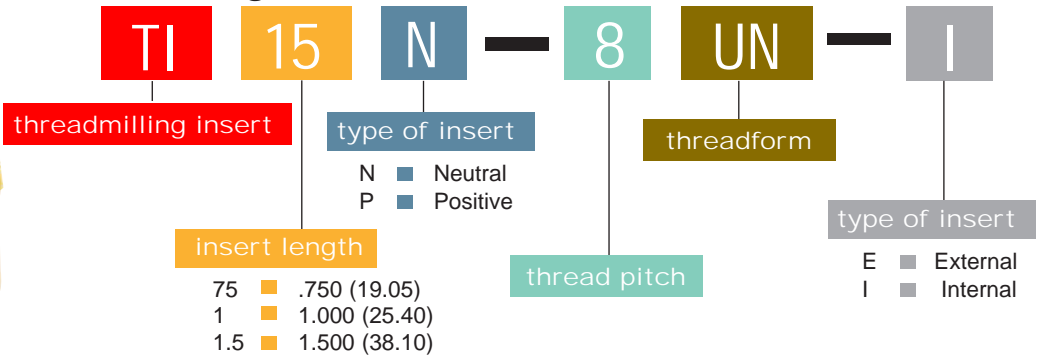

Threadmilling Cutter Nomenclature Chart

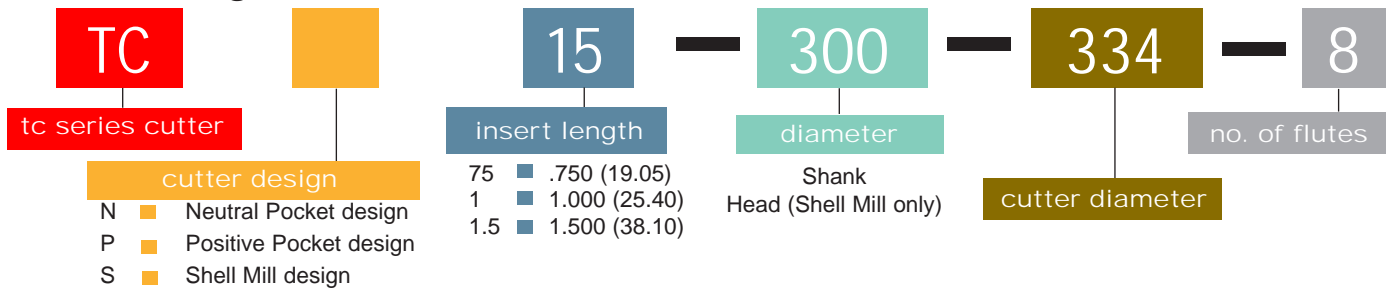

Solid Threadmill Nomenclature Chart

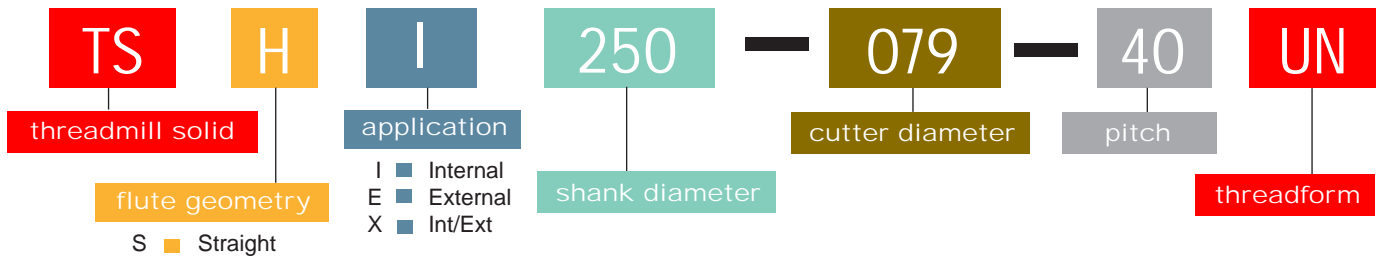

TCT/TCN

- TCT cutters offer tapered head to accommodate NPT and NPTF style inserts
- TCN cutters offer straight head to accommodate UN and ISO style inserts
- Inserts are CNC ground to tolerance of +/- .0005 effective in the cutter
- Positive geometry provides high shear action which results in better quality threads

TCP

- Cutters feature our patented locking system for accurate indexes
- Inserts are CNC ground to tolerance of +/- .0005 effective in the cutter
- Positive geometry provides high shear action which results in better quality threads
- Design allows for maximum number of flutes in minimum part diameter

TCS

- Cutters feature our patented locking system for accurate indexes
- Inserts are CNC ground to tolerance of +/- .0005 effective in the cutter
- Positive geometry provides high shear action which results in better quality threads
- Design allows for maximum number of flutes in minimum part diameter
- Run at high speeds to reduce machining time by as much as 50%

TSSI/X

- Produce better quality threads than tapping
- Excels in materials that are difficult to cut

BSPT THREADING

TI_P

Positive Rake

■ Internal/External

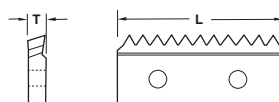

Description	EDP Code	TPI	L	T	Coating		
					C3	GP3	ZS3
TI75P-19BSPT-I/E	TMIA4419I/E	19	19.05	2.03	●	●	●
TI1P-19BSPT-I/E	TMIB4419I/E	19	25.40	3.56	●	●	●
TI1P-14BSPT-I/E	TMIB4414I/E	14	25.40	3.56	●	●	●
TI1N-11BSPT-I/E - Neutral Rake	TMIC4411I/E	11	25.40	3.56	●	●	●



TC SERIES THREADMILLING

BSPB THREADING

TI_P

Positive Rake

Internal/External

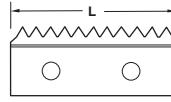
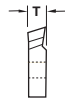

Uncoated	TIN Coated	AlTiN Coated
C3	GP3	ZS3

Description	EDP Code	TPI	L	T
TI75P-19BSPB-I/E	TMIA4419I/E	19	19.05	2.03
TI1P-19BSPB-I/E	TMIB4419I/E	19	25.40	3.56
TI1P-14BSPB-I/E	TMIB4414I/E	14	25.40	3.56

NPT/NPTF THREADING

TI_P

Positive Rake

Internal/External

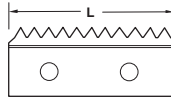
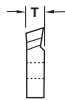

C3	GP3	ZS3
----	-----	-----

Description	EDP Code	TPI	L	T
TI75P-18NPT-I/E	TMIA3618I/E	18	19.05	2.03
TI75P-18NPTF-I/E	TMIA4618I/E	18	19.05	2.03
TI1P-14NPT-I/E	TMIB3614I/E	14	25.40	3.56
TI1P-14NPTF-I/E	TMIB4614I/E	14	25.40	3.56

NPT/NPTF THREADING

TCT_

Cutter Bodies

Internal/External

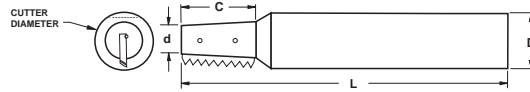

Description	EDP Code	Insert	D	d	L	Cutter Dia	C	Flutes	Screw*
TCT75-13M-400-1	TMTA13M4001	TI75P-18NPT/NPTF/BSPT	13.00	5.82	76.99	10.44	19.00	1	TS250
TCT1-13M-659-1	TMTB13M6591	TI1P-14NPT/NPTF/BSPT	13.00	9.40	76.99	16.74	25.00	1	TS252

*TS250 uses K-2 wrench, TS45 uses K-3 wrench

UN THREADING

TI_P - Positive Rake

Internal

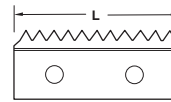
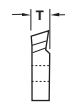

C3	GP3	ZS3
----	-----	-----

Description	EDP Code	TPI	L	T
TI75P-32UN-I	TMIA6632I	32	19.05	2.03
TI75P-24UN-I	TMIA6624I	24	19.05	2.03
TI75P-20UN-I	TMIA6620I	20	19.05	2.03
TI75P-18UN-I	TMIA6618I	18	19.05	2.03
TI75P-16UN-I	TMIA6616I	16	19.05	2.03
TI1P-32UN-I	TMIB6632I	32	25.40	3.56
TI1P-24UN-I	TMIB6624I	24	25.40	3.56
TI1P-20UN-I	TMIB6620I	20	25.40	3.56
TI1P-18UN-I	TMIB6618I	18	25.40	3.56
TI1P-16UN-I	TMIB6616I	16	25.40	3.56
TI1P-14UN-I	TMIB6614I	14	25.40	3.56
TI1P-12UN-I	TMIB6612I	12	25.40	3.56
TI1P-10UN-I*	TMIB6610I	10	25.40	3.56

*To be used in TCN1 750-611-1 cutter only.

UNJ THREADING

TI_P - Positive Rake

Internal

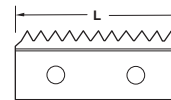
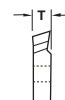

C3	GP3	ZS3
----	-----	-----

Description	EDP Code	TPI	L	T
TI75P-32UNJ-I	TMIA6832I	32	19.05	2.03
TI75P-24UNJ-I	TMIA6824I	24	19.05	2.03
TI75P-20UNJ-I	TMIA6820I	20	19.05	2.03
TI75P-18UNJ-I	TMIA6818I	18	19.05	2.03
TI75P-16UNJ-I	TMIA6816I	16	19.05	2.03
TI1P-32UNJ-I	TMIB6832I	32	25.40	3.56
TI1P-24UNJ-I	TMIB6824I	24	25.40	3.56
TI1P-20UNJ-I	TMIB6820I	20	25.40	3.56
TI1P-18UNJ-I	TMIB6818I	18	25.40	3.56
TI1P-16UNJ-I	TMIB6816I	16	25.40	3.56
TI1P-14UNJ-I	TMIB6814I	14	25.40	3.56
TI1P-12UNJ-I	TMIB6812I	12	25.40	3.56
TI1P-10UNJ-I	TMIB6810I	10	25.40	3.56

THREAD MILLING



ISO THREADING

TI_P - Positive Rake

Internal

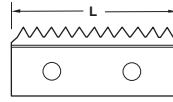
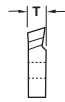

Description	EDP Code	Pitch	L	T	C3	GP3	ZS3
TI75P-1.5 ISO-I	TMIA7015I	1,5	19.05	2.03	●	●	●
TI75P-1.25 ISO-I	TMIA70125I	1,25	19.05	2.03	●	●	●
TI75P-1.0 ISO-I	TMIA7010I	1,0	19.05	2.03	●	●	●
TI75P-0.5 ISO-I	TMIA7005I	0,5	19.05	2.03	●	●	●
TI1P-2.0 ISO-I	TMIB7020I	2,0	25.40	3.56	●	●	●
TI1P-1.5 ISO-I	TMIB7015I	1,5	25.40	3.56	●	●	●
TI1P-1.0 ISO-I	TMIB7010I	1,0	25.40	3.56	●	●	●

UN THREADING

TI_P - Positive Rake

External

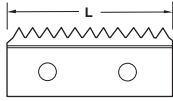
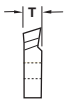

Description	EDP Code	TPI	L	T	C3	GP3	ZS3
TI75P-32UN-E	TMIA6632E	32	19.05	2.03	●	●	●
TI75P-24UN-E	TMIA6624E	24	19.05	2.03	●	●	●
TI75P-20UN-E	TMIA6620E	20	19.05	2.03	●	●	●
TI75P-18UN-E	TMIA6618E	18	19.05	2.03	●	●	●
TI75P-16UN-E	TMIA6616E	16	19.05	2.03	●	●	●
TI1P-32UN-E	TMIB6632E	32	25.40	3.56	●	●	●
TI1P-24UN-E	TMIB6624E	24	25.40	3.56	●	●	●
TI1P-20UN-E	TMIB6620E	20	25.40	3.56	●	●	●
TI1P-18UN-E	TMIB6618E	18	25.40	3.56	●	●	●
TI1P-16UN-E	TMIB6616E	16	25.40	3.56	●	●	●
TI1P-12UN-E	TMIB6612E	12	25.40	3.56	●	●	●

UNJ THREADING

TI_P - Positive Rake

External

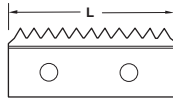
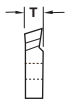

Description	EDP Code	TPI	L	T	C3	GP3	ZS3
TI75P-32UNJ-E	TMIA6832E	32	19.05	2.03	●	●	●
TI75P-24UNJ-E	TMIA6824E	24	19.05	2.03	●	●	●
TI75P-20UNJ-E	TMIA6820E	20	19.05	2.03	●	●	●
TI75P-18UNJ-E	TMIA6818E	18	19.05	2.03	●	●	●
TI75P-16UNJ-E	TMIA6816E	16	19.05	2.03	●	●	●
TI1P-32UNJ-E	TMIB6832E	32	25.40	3.56	●	●	●
TI1P-24UNJ-E	TMIB6824E	24	25.40	3.56	●	●	●
TI1P-20UNJ-E	TMIB6820E	20	25.40	3.56	●	●	●
TI1P-18UNJ-E	TMIB6818E	18	25.40	3.56	●	●	●
TI1P-16UNJ-E	TMIB6816E	16	25.40	3.56	●	●	●
TI1P-12UNJ-E	TMIB6812E	12	25.40	3.56	●	●	●

ISO THREADING

TI_{1P} - Positive Rake

External

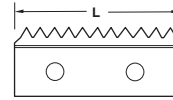
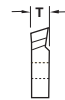

Description	EDP Code	Pitch	L	T	C3	GP3	ZS3
TI1P-2.0 ISO-E	TMIB7020E	2,0	25.40	3.56	●	●	●
TI1P-1.5 ISO-E	TMIB7015E	1,5	25.40	3.56	●	●	●
TI1P-1.0 ISO-E	TMIB7010E	1,0	25.40	3.56	●	●	●

UN THREADING

TCN₁
Cutter Bodies

Internal/External

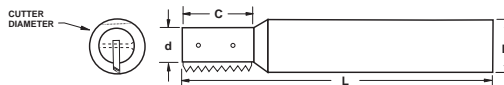

Description	EDP Code	Insert	D	d	L	Cutter Dia	C	Flutes	Screw*
TCN75-13M-394-1#	TMNA13M3941	TI75P-UN/ISO/BSPP/NGT/SGT/UNJ	13.00	6.35	76.99	10.01	19.05	1	TS250
TCN75-13M-468-1#	TMNA13M4681	TI75P-UN/ISO/BSPP/NGT/SGT/UNJ	13.00	8.38	90.47	11.89	19.05	1	TS25
TCN1-20M-625-1	TMNB20M6251	TI1P-UN/ISO/BSPP/NGT/SGT/UNJ	19.20	11.53	90.47	15.88	25.40	1	TSM40
TCN1-20M-611-1	TMNB20M6111	TI1P-10UN	19.20	9.73	90.47	15.52	25.40	1	TSM40

*TS250 and TS25 uses K-2 wrench, TS40 uses K-3 wrench
#Excludes BSPP, NPT and NPTF inserts



TC SERIES THREADMILLING

NGT/SGT THREADING

TI_N

Neutral Rake

Internal/External

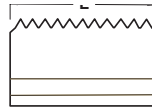

Description	EDP Code	TPI	L	T	C3	Uncoated	TIN Coated	AlTiN Coated
						GP3	ZS3	
TI15N-14NGT-I/E	TMID4714I/E	14	38.10	3.56		●	●	●
TI15N-14SGT-I/E	TMID4914I/E	14	38.10	3.56		●	●	●

NPT/NPTF THREADING

TI_N

Neutral Rake

Internal/External

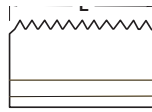

Description	EDP Code	TPI	L	T	C3	Uncoated	TIN Coated	AlTiN Coated
						GP3	ZS3	
TI15N-11.5NPT-I/E	TMID3611I/E	11.5	38.10	3.56		●	●	●
TI15N-11.5NPTF-I/E	TMID4611I/E	11.5	38.10	3.56		●	●	●
TI15N-8NPT-I/E	TMID3608I/E	8	38.10	3.56		●	●	●
TI15N-8NPTF-I/E	TMID4608I/E	8	38.10	3.56		●	●	●

API ROUND THREADING

TI15N

Neutral Rake

Internal/External

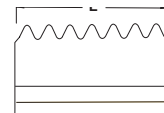

Description	EDP Code	TPI	L	T	C3	Uncoated	TIN Coated	AlTiN Coated
						GP3	ZS3	
TI15N-10RD-I/E	TMID3410I/E	10	38.10	3.56		●	●	●
TI15N-8RD-I/E	TMID3200I/E	8	38.10	3.56		●	●	●

UN THREADING

TI_N

Neutral Rake

Internal

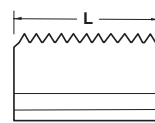
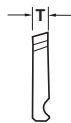

Description	EDP Code	TPI	L	T	C3	Uncoated	TIN Coated	AlTiN Coated
						GP3	ZS3	
TI1N-32UN-I	TMIC6632I	32	25.40	3.56		●	●	●
TI1N-24UN-I	TMIC6624I	24	25.40	3.56		●	●	●
TI1N-20UN-I	TMIC6620I	20	25.40	3.56		●	●	●
TI1N-18UN-I	TMIC6618I	18	25.40	3.56		●	●	●
TI1N-16UN-I	TMIC6616I	16	25.40	3.56		●	●	●
TI1N-12UN-I	TMIC6612I	12	25.40	3.56		●	●	●
TI1N-10UN-I	TMIC6610I	10	25.40	3.56		●	●	●
TI15N-24UN-I	TMID6624I	24	38.10	3.56		●	●	●
TI15N-20UN-I	TMID6620I	20	38.10	3.56		●	●	●
TI15N-18UN-I	TMID6618I	18	38.10	3.56		●	●	●
TI15N-16UN-I	TMID6616I	16	38.10	3.56		●	●	●
TI15N-14UN-I	TMID6614I	14	38.10	3.56		●	●	●
TI15N-12UN-I	TMID6612I	12	38.10	3.56		●	●	●
TI15N-10UN-I	TMID6610I	10	38.10	3.56		●	●	●
TI15N-8UN-I	TMID6608I	8	38.10	3.56		●	●	●
TI15N-7UN-I	TMID6607I	7	38.10	3.56		●	●	●
TI15N-6UN-I	TMID6606I	6	38.10	3.56		●	●	●

THREAD MILLING



UNJ THREADING

TI_N - Neutral Rake

Internal

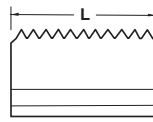
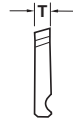

Description	EDP Code	TPI	L	T	Coatings		
					C3	GP3	ZS3
TI1N-32UNJ-I	TMIC6832I	32	25.40	3.56	●	●	●
TI1N-24UNJ-I	TMIC6824I	24	25.40	3.56	●	●	●
TI1N-20UNJ-I	TMIC6820I	20	25.40	3.56	●	●	●
TI1N-18UNJ-I	TMIC6818I	18	25.40	3.56	●	●	●
TI1N-16UNJ-I	TMIC6816I	16	25.40	3.56	●	●	●
TI1N-12UNJ-I	TMIC6812I	12	25.40	3.56	●	●	●
TI1N-10UNJ-I	TMIC6810I	10	25.40	3.56	●	●	●
TI15N-24UNJ-I	TMID6824I	24	38.10	3.56	●	●	●
TI15N-20UNJ-I	TMID6820I	20	38.10	3.56	●	●	●
TI15N-18UNJ-I	TMID6818I	18	38.10	3.56	●	●	●
TI15N-16UNJ-I	TMID6816I	16	38.10	3.56	●	●	●
TI15N-12UNJ-I	TMID6812I	12	38.10	3.56	●	●	●
TI15N-10UNJ-I	TMID6810I	10	38.10	3.56	●	●	●
TI15N-8UNJ-I	TMID6808I	8	38.10	3.56	●	●	●

ISO THREADING

TI15N - Neutral Rake

Internal

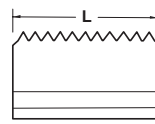
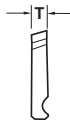

Description	EDP Code	Pitch	L	T	Coatings		
					C3	GP3	ZS3
TI15N-6.0 ISO-I	TMID7060I	6.0	38.10	3.56	●	●	●
TI15N-5.0 ISO-I	TMID7050I	5.0	38.10	3.56	●	●	●
TI15N-4.5 ISO-I	TMID7045I	4.5	38.10	3.56	●	●	●
TI15N-4.0 ISO-I	TMID7040I	4.0	38.10	3.56	●	●	●
TI15N-3.5 ISO-I	TMID7035I	3.5	38.10	3.56	●	●	●
TI15N-3.0 ISO-I	TMID7030I	3.0	38.10	3.56	●	●	●
TI15N-2.5 ISO-I	TMID7025I	2.5	38.10	3.56	●	●	●
TI15N-2.0 ISO-I	TMID7020I	2.0	38.10	3.56	●	●	●
TI15N-1.5 ISO-I	TMID7015I	1.5	38.10	3.56	●	●	●

ACME THREADING

TI_N - Neutral Rake - Full Profile

Internal/External

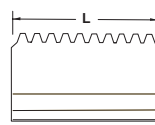
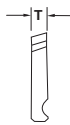

Description	EDP Code	TPI	L	T	Coatings		
					C3	GP3	ZS3
TI1N-12ACME-I	TMIC0212I	12	25.40	3.56	●	●	●
TI1N-10ACME-I	TMIC0210I	10	25.40	3.56	●	●	●
TI1N-8ACME-I	TMIC0208I	8	25.40	3.56	●	●	●
TI15N-12ACME-I	TMID0212I	12	38.10	3.56	●	●	●
TI15N-10ACME-I	TMID0210I	10	38.10	3.56	●	●	●
TI15N-8ACME-I	TMID0208I	8	38.10	3.56	●	●	●
TI15N-6ACME-I	TMID0206I	6	38.10	3.56	●	●	●
TI15N-5ACME-I	TMID0205I	5	38.10	3.56	●	●	●
TI15N-4ACME-I	TMID0204I	4	38.10	3.56	●	●	●

UN THREADING

TI_N - Neutral Rake

External

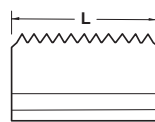

Description	EDP Code	TPI	L	T	Coatings		
					C3	GP3	ZS3
TI1N-32UN-E	TMIC6632E	32	25.40	3.56	●	●	●
TI1N-24UN-E	TMIC6624E	24	25.40	3.56	●	●	●
TI1N-20UN-E	TMIC6620E	20	25.40	3.56	●	●	●
TI1N-18UN-E	TMIC6618E	18	25.40	3.56	●	●	●
TI1N-16UN-E	TMIC6616E	16	25.40	3.56	●	●	●
TI1N-12UN-E	TMIC6612E	12	25.40	3.56	●	●	●
TI1N-10UN-E	TMIC6610E	10	25.40	3.56	●	●	●
TI15N-24UN-E	TMID6624E	24	38.10	3.56	●	●	●
TI15N-20UN-E	TMID6620E	20	38.10	3.56	●	●	●
TI15N-18UN-E	TMID6618E	18	38.10	3.56	●	●	●
TI15N-16UN-E	TMID6616E	16	38.10	3.56	●	●	●
TI15N-12UN-E	TMID6612E	12	38.10	3.56	●	●	●
TI15N-10UN-E	TMID6610E	10	38.10	3.56	●	●	●
TI15N-8UN-E	TMID6608E	8	38.10	3.56	●	●	●
TI15N-6UN-E	TMID6606E	6	38.10	3.56	●	●	●



TC SERIES THREADMILLING

UNJ THREADING

TI_N

Neutral Rake

External

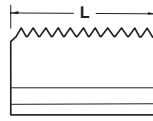
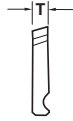

	Uncoated	TIN Coated	AlTiN Coated
C3	●	●	●
GP3	●	●	●
ZS3	●	●	●

Description	EDP Code	TPI	L	T	C3	GP3	ZS3
TI1N-32UNJ-E	TMIC6832E	32	25.40	3.56	●	●	●
TI1N-24UNJ-E	TMIC6824E	24	25.40	3.56	●	●	●
TI1N-20UNJ-E	TMIC6820E	20	25.40	3.56	●	●	●
TI1N-18UNJ-E	TMIC6818E	18	25.40	3.56	●	●	●
TI1N-16UNJ-E	TMIC6816E	16	25.40	3.56	●	●	●
TI1N-12UNJ-E	TMIC6812E	12	25.40	3.56	●	●	●
TI1N-10UNJ-E	TMIC6810E	10	25.40	3.56	●	●	●
TI15N-24UNJ-E	TMID6824E	24	38.10	3.56	●	●	●
TI15N-20UNJ-E	TMID6820E	20	38.10	3.56	●	●	●
TI15N-18UNJ-E	TMID6818E	18	38.10	3.56	●	●	●
TI15N-16UNJ-E	TMID6816E	16	38.10	3.56	●	●	●
TI15N-12UNJ-E	TMID6812E	12	38.10	3.56	●	●	●
TI15N-10UNJ-E	TMID6810E	10	38.10	3.56	●	●	●
TI15N-8UNJ-E	TMID6808E	8	38.10	3.56	●	●	●

ISO THREADING

TI15N

Neutral Rake

External

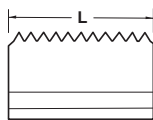

	Uncoated	TIN Coated	AlTiN Coated
C3	●	●	●
GP3	●	●	●
ZS3	●	●	●

Description	EDP Code	Pitch	L	T	C3	GP3	ZS3
TI15N-6.0 ISO-E	TMID7060E	6.0	38.10	3.56	●	●	●
TI15N-5.0 ISO-E	TMID7050E	5.0	38.10	3.56	●	●	●
TI15N-4.5 ISO-E	TMID7045E	4.5	38.10	3.56	●	●	●
TI15N-4.0 ISO-E	TMID7040E	4.0	38.10	3.56	●	●	●
TI15N-2.0 ISO-E	TMID7020E	2.0	38.10	3.56	●	●	●

UN/NPT/ISO/ACME/API THREADING

TCP_

Cutter Bodies

Internal/External

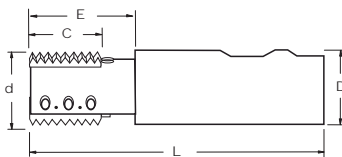

Description	EDP Code	Insert	Coolant Port	D	d	E	L	Cutter Dia. (UN/115NPT)	Cutter Dia. (8NPT)	C	Flutes	Screw	Pin
TCP1 25M-969-2	TMPB25M9692	TI1N		25.00	19.05	38.10	114.30	24.61	24.61	25.40	2	TSSM-3	DP1
TCP1 32M-175-5	TMPB32M1755	TI1N	✓	32.00	38.10	44.45	101.60	44.58	44.58	25.40	5	TSSM-2	DP1
TCP15 25M-932-1	TMPC25M9321	TI15N		25.00	18.34	48.26	114.30	23.67	27.05	38.10	1	TSSM-2	DP135
TCP15 25M-969-2	TMPC25M9692	TI15N		25.00	18.34	50.80	127.00	24.61	27.05	38.10	2	TSSM-2	DP135
TCP15 25M-111-3	TMPC25M1113	TI15N	✓	25.00	27.81	70.82	139.70	28.35	31.67	38.10	3	TSSM-3	DP135
TCP15 32M-175-5	TMPC32M1755	TI15N	✓	32.00	38.10	64.77	114.30	44.58	47.96	38.10	5	TSSM-2	DP135

THREAD MILLING

UN/NPT/ISO/ACME THREADING

TCS_

Shell Mill Cutter Bodies

Internal/External

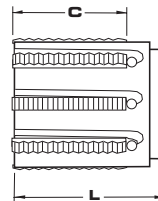
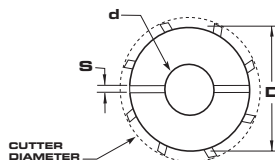

Description	EDP Code	Insert	D	d	S	L	Cutter Dia.	C	Flutes	Pin	Screw
TCS15 200-234-6	TMSC322346	TI15N	50.80	19.05	6.35	57.15	59.66	38.10	6	DP135	TSSM-3
TCS15 250-274-7	TMSC402747	TI15N	63.50	25.40	9.53	57.15	72.29	38.10	7	DP135	TSSM-3
TCS15 300-334-8	TMSC483348	TI15N	76.20	31.75	12.70	57.15	84.86	38.10	8	DP135	TSSM-3



BSPP THREADING

TSHX

Solid Threadmills

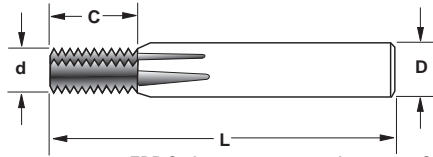

AC22
TiN Coated

Min. I.D. Thread/TPI	Description	EDP Code	d	C	Flutes	D	L	AC22
1/16 & 1/8 - 28	TSHX 6M-597-28BSPP	TSHX6M59728BSPP	5.97	14.53	3	6	51	●
1/4 & 3/8 - 19	TSHX 10M-991-19BSPP	TSHX10M99119BSPP	9.91	18.72	4	10	73	●
1/2 & 3/4 - 14	TSHX 12M-1194-14BSPP	TSHX12M119414BSPP	11.94	29.03	4	12	84	●
1" & 2" - 11	TSHX 16M-1575-11BSPP	TSHX16M157511BSPP	15.75	34.67	4	16	93	●

BSPT THREADING

TSHX

Internal/External

Min. I.D. Thread/TPI	Description	EDP Code	d	C	Flutes	D	L	AC22
1/16 & 1/8 - 28	TSHX 6M-597-28BSPT	TSHX6M59728BSPT	5.97	9.98	3	6	51	●
1/4 & 3/8 - 19	TSHX 10M-991-19BSPT	TSHX10M99119BSPT	9.91	14.73	4	10	73	●
1/2 & 3/4 - 14	TSHX 12M-1194-14BSPT	TSHX12M119414BSPT	11.94	20.00	4	12	84	●
1" & 2" - 11	TSHX 16M-1575-11BSPT	TSHX16M157511BSPT	15.75	32.31	4	16	93	●

ISO THREADING

TSHI

Min. I.D. Thread/Pitch	Description	EDP Code	d	C	Flutes	D	L	AC22
M2 - 0.4	TSHI 3M-150-0.4ISO	TMCH3M15004ISO	1.50	3.20	3	3.00	39.00	●
M2.5 - 0.45	TSHI 3M-150-0.45ISO	TMCH3M150045ISO	1.50	3.60	3	3.00	39.00	●
M3 - 0.5	TSHI 3M-215-0.5ISO	TMCH3M21505ISO	2.15	4.50	3	3.00	39.00	●
M4.5 - 0.75	TSHI 4M-300-0.75ISO	TMCH3M21-05ISO	3.00	6.75	3	4.00	51.00	●
M5 - 0.8	TSHI 4M-360-0.8ISO	TMCH4M360-08ISO	3.60	8.00	3	4.00	51.00	●
M6 - 1.0	TSHI 6M-460-1.0ISO	TMCH6M46010ISO	4.60	12.00	3	6.00	51.00	●
M8 - 1.25	TSHI 6M-590-1.25ISO	TMCH6M590125ISO	5.90	16.25	3	6.00	51.00	●
M10 - 1.5	TSHI 8M-740-1.5ISO	TMCH8M74015ISO	7.40	19.50	4	8.00	64.00	●
M10 - 0.75	TSHI 8M-795-0.75ISO	TMCH8M795075ISO	7.95	15.00	4	8.00	64.00	●
M10 - 0.5	TSHI 8M-795-0.5ISO	TMCH8M79505ISO	7.95	15.00	4	8.00	64.00	●
M12 - 1.75	TSHI 10M-940-1.75ISO	TMCH10M940175ISO	9.40	22.71	4	10.00	73.00	●
M12 - 1.0	TSHI 10M-940-1.0ISO	TMCH10M94010ISO	9.40	20.00	4	10.00	73.00	●
M14 - 1.5	TSHI 12M-1090-1.5ISO	TMCH12M109015ISO	10.90	27.00	4	12.00	84.00	●
M14 - 2.0	TSHI 12M-1090-2.0ISO	TMCH12M109020ISO	10.90	28.00	4	12.00	84.00	●
M18 - 1.5	TSHI 12M-1090-1.5ISO	TMCH12M109015ISO	11.90	31.50	4	12.00	84.00	●
M20 - 2.5	TSHI 12M-1090-2.5ISO	TMCH12M109025ISO	11.90	30.00	4	12.00	84.00	●
M20 - 2.0	TSHI 12M-1195-2.0ISO	TMCH12M119520ISO	11.95	30.00	4	12.00	84.00	●
M24 - 3.0	TSHI 16M-1590-3.0ISO	TMCH16M159030ISO	15.90	36.00	4	16.00	93.00	●
M30 - 3.5	TSHI 16M-1575-3.5ISO	TMCH16M157535ISO	15.75	38.50	4	16.00	100.00	●
M36 - 4.0	TSHI 20M-1990-4.0ISO	TMCH20M199040ISO	19.90	40.00	5	20.00	105.00	●

NPT THREADING

TSHX

Min. I.D. Thread/TPI	Description	EDP Code	d	C	Flutes	D	L	AC22
1/16" & 1/8" - 27	TSHX 6M-595-27NPT	TMXH6M59527NPT	5.95	11.30	3	6	58	●
1/4" & 3/8" - 18	TSHX 8M-775-18NPT	TMXH8M77518NPT	7.75	15.70	4	8	64	●
1/2" & 3/4" - 14	TSHX 12M-1195-14NPT	TMXH12M119514NPT	11.95	23.70	4	12	84	●
1" & 2" to 11.5	TSHX 16M-1575-11.5NPT	TMXH16M1575115NPT	15.75	28.75	4	16	93	●
2-1/2" to 6" - 8	TSHX 20M-1975-8NPT	TMXH20M19758NPT	19.75	38.10	5	20	115	●

NPTF THREADING

TSHX

Min. I.D. Thread/TPI	Description	EDP Code	d	C	Flutes	D	L	AC22
1/16" & 1/8" - 27	TSHX 6M-595-27NPTF	TMXH6M59527NPTF	5.95	11.30	3	6	58	●
1/4" & 3/8" - 18	TSHX 8M-775-18NPTF	TMXH8M77518NPTF	7.75	15.70	4	8	64	●
1/2" & 3/4" - 14	TSHX 12M-1195-14NPTF	TMXH12M119514NPTF	11.95	23.70	4	12	84	●
1" & 2" to 11.5	TSHX 16M-1575-11.5NPTF	TMXH16M1575115NPTF	15.75	28.75	4	16	93	●
2-1/2" to 6" - 8	TSHX 20M-1975-8NPTF	TMXH20M19758NPTF	19.75	38.10	5	20	115	●



Threadmilling Kits



NPT THREADING KITS

18NPT-THREADING KIT #101

Kit Contents

1	TCT75 500-400-1
4	TI75-18NPT AC3
1	T8 WRENCH
1	TS252 INSERT SCREW

14NPT-THREADING KIT #102

Kit Contents

1	TCT1 500-659-1
4	TI1P-14NPT AC3
1	T8 WRENCH
1	TS252 INSERT SCREW

UN THREADING KITS

16UN-THREADING KIT #201

Kit Contents

1	TCN75 500-394-1
4	TI75P-16UN AC3
1	T8 WRENCH
1	TS252 INSERT SCREW

18UN-THREADING

Kit Contents

1	TCN75 500-394-1
4	TI75P-18UN AC3
1	T8 WRENCH
1	TS252 INSERT SCREW

24UN-THREADING KIT #204

Kit Contents

1	TCN75 500-394-1
4	TI75P-24UN AC3
1	T6 WRENCH
1	TS252 INSERT SCREW

20UN-THREADING KIT #203

Kit Contents

1	TCN75 500-394-1
4	TI75P-20UN AC3
1	T8 WRENCH
1	TS252 INSERT SCREW

32UN-THREADING KIT #205

Kit Contents

1	TCN75 500-394-1
4	TI75P-32UN AC3
1	T6 WRENCH
1	TS252 INSERT SCREW

*We welcome specials!
Please call us with your
specs.*

Technical Information

NPT & NPTF

When programming an NPT or NPTF thread form, a correction factor to compensate for the tapered thread form may need to be made. This is achieved by dividing the circular move into quarters or eighths, and moving the cutter out as the arc is generated so that the taper is included in the movement. The amount of taper for a given form is determined by the following formula:

$$\text{Taper per pitch} = \frac{.0625''}{\text{pitch}}$$

This amount of taper per pitch is then divided by number of programmed quadrants. This determines the amount that the cutter forms of the thread.

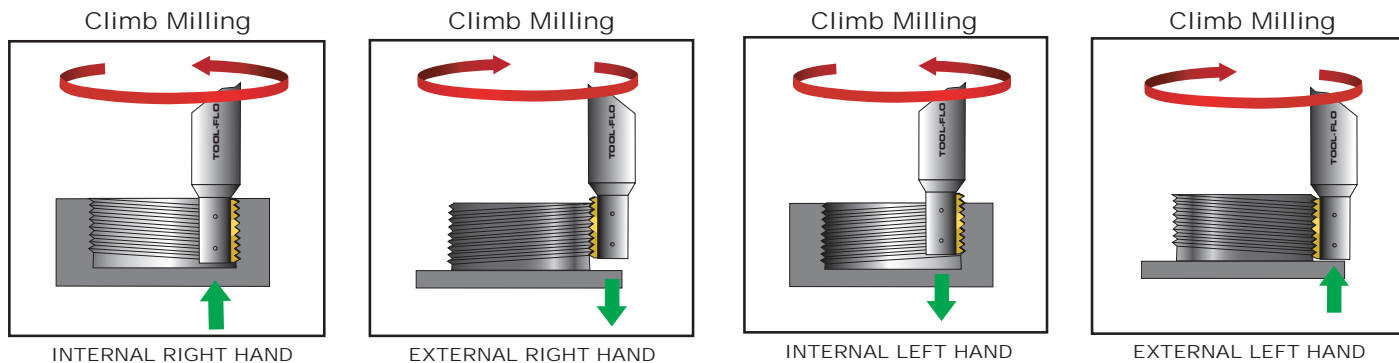

THREAD MILLING

NPT SELECTION CHART		
SIZE	CUTTER	INSERT
1/4", 3/8"	TCT75 500-400-1	TI75P-18NPT
1/2", 3/4"	TCT1 500-659-1	TI1P-14NPT
1"	TCP15 100-932-1	TI15N-11.5NPT
1-1/4", 1-1/2"	TCP15 100-111-3	TI15N-11.5NPT
2"	TCP15 125-175-5	TI15N-11.5NPT
3"	TCP15 125-175-5	TI15N-8NPT

RECOMMENDED SPEED AND FEED RATES		
MATERIAL	CHIP LOAD	SPEED (MM/M)
1018 Steel	0.020 - 0.051	76.20 - 152.40
Standard steel (4140)	0.013 - 0.051	53.34 - 106.68
300 Series Stainless	0.013 - 0.089	76.20 - 152.40
400 Series Stainless	0.005 - 0.038	38.10 - 91.44
Gray Iron	0.013 - 0.076	121.92 - 243.84
Ductile iron	0.025 - 0.013	182.88 - 304.80
Aluminum	0.038 - 0.152	243.84 - 365.76
Brass	0.051 - 0.165	121.92 - 213.36



Technical Information

Minimum internal thread size vs threads per pitch for given cutter body for ISO threads

cutter body	pitch	0.5	1.0	1.25	1.5	2.0	2.5	3.0	3.5	4.0	4.5	5.0	6.0
TCN75 500-394-1		M16	M16	M16	M16								
TCN75 500-468-1		M18	M18	M18	M20								
TCN1 750-625-1			M24		M25	M25							
TCP15 100-932-1					M36	M36	M39	M39	M39	M39	M42	M48	M50
TCP15 100-111-3					M45	M45	M45	M45	M48	M48	M48	M48	M52
TCP15 125-175-5					M68	M68	M68	M68	M70	M70	M72	M72	M72

Minimum internal thread size vs threads per inch (tpi) for given cutter body for UN threads

cutter body	tpi	32	24	20	18	16	14	12	10	8	7	6
TCN75 500-394-1		5/8"	5/8"	5/8"	3/4"	11/16"						
TCN75 500-468-1		3/4"	3/4"	3/4"	3/4"	13/16"						
TCN1 750-625-1		15/16"	1"	1"	1"	1-1/16"	1-1/8"	1-1/8"	1-1/8"			
TCP1 100-969-2			1-1/2"	1-1/2"	1-7/16"	1-1/2"	1-1/2"	1-1/2"	1-1/2"			
TCP1 125-175-5				2-5/8"	2-5/8"	2-5/8"	2-3/4"	2-3/4"	2-3/4"			
TCP15 100-932-1				1-7/16"	1-7/16"	1-7/16"	1-7/16"	1-1/2"	1-1/2"	1-1/2"	1-5/8"	1-5/8"
TCP15 100-111-3				1-11/16"	1-11/16"	1-11/16"	1-3/4"	1-11/16"	1-3/4"	1-3/4"	1-13/16"	1-13/16"
TCP15 125-175-5				2-5/8"	2-5/8"	2-5/8"	2-3/4"	2-3/4"	2-3/4"	2-3/4"	2-3/4"	2-3/4"

THREAD MILLING



TURNING



TURNING

SNMG

90° General Purpose

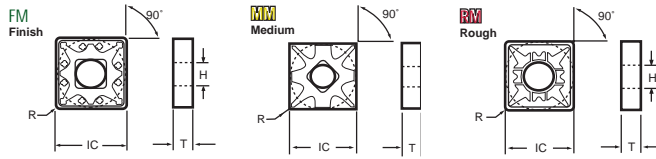

ANSI Description	ISO Description	EDP Code	IC	R	T	H	AGS50	AGS54	AS20	APS35
SNMG-431 FM	SNMG-120404 FM	JNMGJ1FM	1/2	0.41	4.75	5.16	●	●	●	●
SNMG-432 FM	SNMG-120408 FM	JNMGJ2FM	1/2	0.79	4.75	5.16	●	●	●	●
SNMG-432 MM	SNMG-120408 MM	JNMGJ2MM	1/2	0.79	4.75	5.16	●	●	●	●
SNMG-432 RM	SNMG-120408 RM	JNMGJ2RM	1/2	0.79	4.75	5.16	●	●	●	●
SNMG-433 RM	SNMG-120412 RM	JNMGJ3RM	1/2	1.19	4.75	5.16	●	●	●	●

Steel grades
Cast iron grades
Stainless/Exotic

TNMG

60° General Purpose

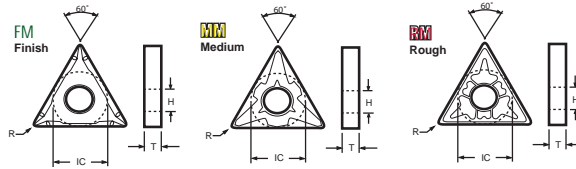

ANSI Description	ISO Description	EDP Code	IC	R	T	H	AGS50	AGS54	AS20	APS35
TNMG-331 FM	TNMG-160404 MNS	JTMGH1MNS	3/8	0.41	4.75	3.81	●	●	●	●
TNMG-331 MM	TNMG-160408 FNC	JTMGH2FNC	3/8	0.79	4.75	3.81	●	●	●	●
TNMG-332 FM	TNMG-160408 FNS	JTMGH2FNS	3/8	0.79	4.75	3.81	●	●	●	●
TNMG-332 MM	TNMG-160408 MNS	JTMGH2MNS	3/8	0.79	4.75	3.81	●	●	●	●
TNMG-332 RM	TNMG-160408 RNS	JTMGH2RNS	3/8	0.79	4.75	3.81	●	●	●	●
TNMG-333 MM	TNMG-160412 MNS	JTMGH3MNS	3/8	1.19	4.75	3.81	●	●	●	●
TNMG-333 RM	TNMG-160412 RNS	JTMGH3RNS	3/8	1.19	4.75	3.81	●	●	●	●

Steel grades
Cast iron grades
Stainless/Exotic

VNMG

35° General Purpose

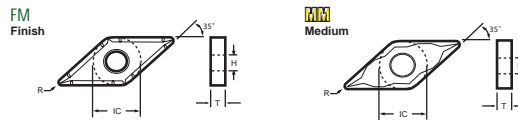

ANSI Description	ISO Description	EDP Code	IC	R	T	H	AGS50	AGS54	AS20	APS35
VNMG-331 FM	VNMG-160404 FM	JXMGH1FM	3/8	0.41	4.75	3.81	●	●	●	●
VNMG-331 MM	VNMG-160404 MM	JXMGH1MM	3/8	0.41	4.75	3.81	●	●	●	●

Steel grades
Cast iron grades
Stainless/Exotic

WNMG

80° General Purpose

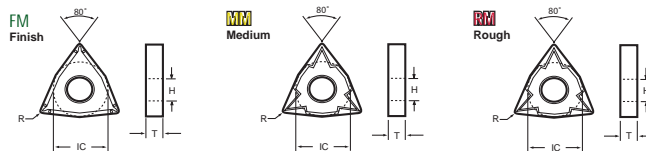

ANSI Description	ISO Description	EDP Code	IC	R	T	H	AGS50	AGS54	AS20	APS35
WNMG-332 MM	WNMG-060408 MM	JZMAH2MM	3/8	0.79	4.75	3.81	●	●	●	●
WNMG-431 FM	WNMG-080404 FM	JZMAJ1FM	1/2	0.41	4.75	5.16	●	●	●	●
WNMG-431 MM	WNMG-080404 MM	JZMAJ1MM	1/2	0.41	4.75	5.16	●	●	●	●
WNMG-432 FM	WNMG-080408 FM	JZMAJ2FM	1/2	0.79	4.75	5.16	●	●	●	●
WNMG-432 MM	WNMG-080408 MM	JZMAJ2MM	1/2	0.79	4.75	5.16	●	●	●	●
WNMG-432 RM	WNMG-080408 RM	JZMAJ2RM	1/2	0.79	4.75	5.16	●	●	●	●
WNMG-433 MM	WNMG-080412 MM	JZMAJ3MM	1/2	1.19	4.75	5.16	●	●	●	●
WNMG-433 RM	WNMG-080412 RM	JZMAJ2RM	1/2	1.19	4.75	5.16	●	●	●	●

Steel grades
Cast iron grades
Stainless/Exotic

In an effort to improve our stock standard grade offering, there are periodic changes. Please see current price list for up to date grade offering.

TURNING



CCMT 80° Screwdown

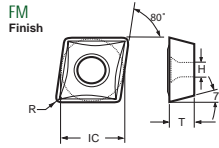

ANSI Description	ISO Description	EDP Code	IC	R	T	H	AGS50	AGS54	AS20	APS35
CCMT-21.51 FM	CCMT-060204 FM	JAMTD1FM	1/4	0.41	2.39	2.90				●
CCMT-32.51 FM	CCMT-09T304 FM	JAMTG1FM	3/8	0.41	3.96	4.50				●
CCMT-32.52 FM	CCMT-09T308 FM	JAMTG2FM	3/8	0.79	3.96	4.50				●
CCMT-431 FM	CCMT-120404 FM	JAMTJ1FM	1/2	0.41	4.75	5.16				●
CCMT-432 FM	CCMT-120408 FM	JAMTJ2FM	1/2	0.79	4.75	5.16				●

DCMT 55° Screwdown

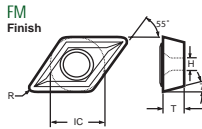

ANSI Description	ISO Description	EDP Code	IC	R	T	H	AGS50	AGS54	AS20	APS35
DCMT-21.51 FM	DCMT-070204 FM	JDMTD1FM	1/4	0.41	2.39	2.90		●	●	
DCMT-21.52 FM	DCMT-070208 FM	JDMTD2FM	1/4	0.79	2.39	2.90		●	●	
DCMT-32.51 FM	DCMT-11T302 FM	JDMTG0FM	3/8	0.41	3.96	4.50		●	●	
DCMT-32.52 FM	DCMT-11T304 FM	JDMTG2FM	3/8	0.79	3.96	4.50		●	●	

SCMT 90° Screwdown

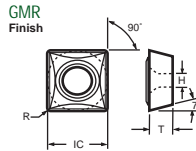

ANSI Description	ISO Description	EDP Code	IC	R	T	H	AGS50	AGS54	AS20	APS35
SCMT-32.51 GMR	SCMT-09T304 GMR	JLMTG1GMR	3/8	0.41	3.96	2.97	●			

TCMT 60° Screwdown

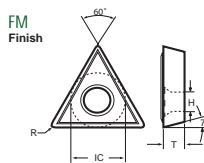

ANSI Description	ISO Description	EDP Code	IC	R	T	H	AGS50	AGS54	AS20	APS35
TCMT-21.51 FM	TCMT-110204 FM	JQMTD1FM	1/4	0.41	2.39	2.90				
TCMT-21.52 FM	TCMT-110208 FM	JQMTD2FM	1/4	0.79	2.39	2.90				
TCMT-32.51 FM	TCMT-16T304 FM	JQMTG1FM	3/8	0.41	3.96	4.50				
TCMT-32.52 FM	TCMT-16T308 FM	JQMTG2FM	3/8	0.79	3.96	4.50				

VCMT 35° Screwdown

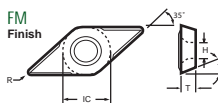

ANSI Description	ISO Description	EDP Code	IC	R	T	H	AGS50	AGS54	AS20	APS35
VCMT-331 FM	VCMT-160404 FM	JWMT11FM	3/8	0.41	4.75	4.39	●	●		
VCMT-332 FM	VCMT-160408 FM	JWMT12FM	3/8	0.79	4.75	4.39				

In an effort to improve our stock standard grade offering, there are periodic changes. Please see current price list for up to date grade offering.



TURNING

MCFNL/R

10° Holder for 80° Diamond

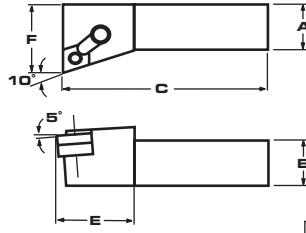

RH SHOWN

PARTS

Description	EDP Code	Insert	A	B	C	E	F	Seat	Lock Pin	Clamp	Clamp Screw	Seat Screw
MCFNR-2525M4D	9T25225M56D	CN_-43	25	25	150	31.75	31.75	ICSN-433	NLM46	CLM20	STCM11	S-46
MCFNL-2525M4D	9T25025M56D	CN_-43	25	25	150	31.75	31.75	ICSN-433	NLM46	CLM20	STCM11	S-46
MCFNR-2525M5D	9T25225M64D	CN_-54	25	25	150	35.05	31.75	ICSN-533	NLM58	CLM12	XNSC0825	S-58
MCFNL-2525M5D	9T25025M64D	CN_-54	25	25	150	35.05	31.75	ICSN-533	NLM58	CLM12	XNSC0825	S-58
MCFNR-3232M5D	9T25232M64D	CN_-54	32	32	170	35.05	38.10	ICSN-533	NLM58	CLM12	XNSC0825	S-58
MCFNL-3232M5D	9T25032M64D	CN_-54	32	32	170	35.05	38.10	ICSN-533	NLM58	CLM12	XNSC0825	S-58
MCFNR-2525M6D	9T25225M72D	CN_-64	25	25	150	38.10	31.75	ICSN-633	NLM68	CLM9	XNSC0825	S-68
MCFNL-2525M6D	9T25025M72D	CN_-64	25	25	150	38.10	31.75	ICSN-633	NLM68	CLM9	XNSC0825	S-68
MCFNR-3232M6D	9T25232M72D	CN_-64	32	32	170	38.10	38.10	ICSN-633	NLM68	CLM9	XNSC0825	S-68
MCFNL-3232M6D	9T25032M72D	CN_-64	32	32	170	38.10	38.10	ICSN-633	NLM68	CLM9	XNSC0825	S-68

MCGNL/R

10° Holder for 80° Diamond

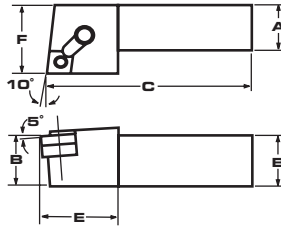

RH SHOWN

PARTS

Description	EDP Code	Insert	A	B	C	E	F	Seat	Lock Pin	Clamp	Clamp Screw	Seat Screw
MCGNR-2525M4D	9T25825M56D	CN_-43	25	25	150	31.75	31.75	ICSN-433	NLM46	CLM20	STCM11	S-46
MCGNL-2525M4D	9T25625M56D	CN_-43	25	25	150	31.75	31.75	ICSN-433	NLM46	CLM20	STCM11	S-46
MCGNR-2525M5D	9T25825M64D	CN_-54	25	25	150	35.05	31.75	ICSN-533	NLM58	CLM12	XNSC0825	S-58
MCGNL-2525M5D	9T25625M64D	CN_-54	25	25	150	35.05	31.75	ICSN-533	NLM58	CLM12	XNSC0825	S-58
MCGNR-3232M5D	9T25832M64D	CN_-54	32	32	170	35.05	38.10	ICSN-533	NLM58	CLM12	XNSC0825	S-58
MCGNL-3232M5D	9T25632M64D	CN_-54	32	32	170	35.05	38.10	ICSN-533	NLM58	CLM12	XNSC0825	S-58
MCGNR-2525M6D	9T25825M72D	CN_-64	25	25	150	38.10	31.75	ICSN-633	NLM68	CLM12	XNSC0825	S-68
MCGNL-2525M6D	9T25625M72D	CN_-64	25	25	150	38.10	31.75	ICSN-633	NLM68	CLM12	XNSC0825	S-68
MCGNR-3232M6D	9T25832M72D	CN_-64	32	32	170	38.10	38.10	ICSN-633	NLM68	CLM12	XNSC0825	S-68
MCGNL-3232M6D	9T25632M72D	CN_-64	32	32	170	38.10	38.10	ICSN-633	NLM68	CLM12	XNSC0825	S-68

MCKNL/R

15° Holder for 80° Diamond

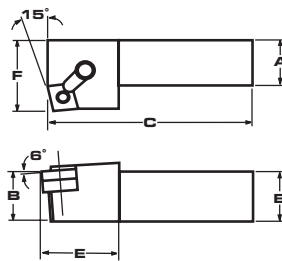

RH SHOWN

PARTS

Description	EDP Code	Insert	A	B	C	E	F	Seat	Lock Pin	Clamp	Clamp Screw	Seat Screw
MCKNR-2020M4B	9T2641256B	CN_-43	20	20	125	30.73	25.40	ICSN-433	NLM46	CLM20	STCM11	S-46
MCKNL-2020M4B	9T2621256B	CN_-43	20	20	125	30.73	25.40	ICSN-433	NLM46	CLM20	STCM11	S-46
MCKNR-2525M4D	9T2641656D	CN_-43	25	25	150	31.75	31.75	ICSN-433	NLM46	CLM20	STCM11	S-46
MCKNL-2525M4D	9T2621656D	CN_-43	25	25	150	31.75	31.75	ICSN-433	NLM46	CLM20	STCM11	S-46
MCKNR-3232M4D	9T2642056D	CN_-43	32	32	170	31.75	38.10	ICSN-433	NLM46	CLM20	STCM11	S-46
MCKNL-3232M4D	9T2622056D	CN_-43	32	32	170	31.75	38.10	ICSN-433	NLM46	CLM20	STCM11	S-46
MCKNR-2525M5D	9T2641664D	CN_-54	25	25	150	38.10	31.75	ICSN-533	NLM58	CLM9	STCM8	S-58
MCKNL-2525M5D	9T2621664D	CN_-54	25	25	150	38.10	31.75	ICSN-533	NLM58	CLM9	STCM8	S-58
MCKNR-3232M5D	9T2642064D	CN_-54	32	32	170	38.10	38.10	ICSN-533	NLM58	CLM9	STCM8	S-58
MCKNL-3232M5D	9T2622064D	CN_-54	32	32	170	38.10	38.10	ICSN-533	NLM58	CLM9	STCM8	S-58
MCKNR-2525M6D	9T2641672D	CN_-64	25	25	150	37.34	31.75	ICSN-633	NLM68	CLM12	XNSC0825	S-68
MCKNL-2525M6D	9T2621672D	CN_-64	25	25	150	37.34	31.75	ICSN-633	NLM68	CLM12	XNSC0825	S-68
MCKNR-3232M6D	9T2642072D	CN_-64	32	32	170	37.34	38.10	ICSN-633	NLM68	CLM12	XNSC0825	S-68
MCKNL-3232M6D	9T2622072D	CN_-64	32	32	170	37.34	38.10	ICSN-633	NLM68	CLM12	XNSC0825	S-68
MCKNR-4040M6E	9T2642472E	CN_-64	40	40	250	37.34	50.80	ICSN-633	NLM68	CLM12	XNSC0825	S-68
MCKNL-4040M6E	9T2622472E	CN_-64	40	40	250	37.34	50.80	ICSN-633	NLM68	CLM12	XNSC0825	S-68



MCLNL/R

5° Holder for 80° Diamond

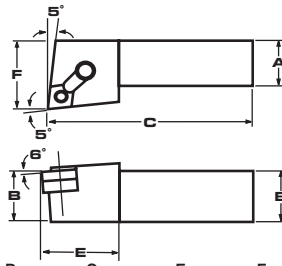

RH SHOWN

PARTS

Description	EDP Code	Insert	A	B	C	E	F	PARTS				
								Seat	Lock Pin	Clamp	Clamp Screw	Seat Screw
MCLNR-1616M4A	9T28016M56A	CN_-43	16	16	100	30.48	25.40	ICSN-433	NLM46	CLM20	STCM11	S-46
MCLNL-1616M4A	9T27816M56A	CN_-43	16	16	100	30.48	25.40	ICSN-433	NLM46	CLM20	STCM11	S-46
MCLNR-2020M4B	9T28020M56B	CN_-43	20	20	125	30.48	25.40	ICSN-433	NLM46	CLM20	STCM11	S-46
MCLNL-2020M4B	9T27820M56B	CN_-43	20	20	125	30.48	25.40	ICSN-433	NLM46	CLM20	STCM11	S-46
MCLNR-2525M4C	9T28025M56C	CN_-43	25	25	150	30.48	31.75	ICSN-433	NLM46	CLM20	STCM11	S-46
MCLNL-2525M4C	9T27825M56C	CN_-43	25	25	150	30.48	31.75	ICSN-433	NLM46	CLM20	STCM11	S-46
MCLNR-2525M4D	9T28025M56D	CN_-43	25	25	150	30.48	31.75	ICSN-433	NLM46	CLM20	STCM11	S-46
MCLNL-2525M4D	9T27825M56D	CN_-43	25	25	150	30.48	31.75	ICSN-433	NLM46	CLM20	STCM11	S-46
MCLNR-3232M4D	9T28032M56D	CN_-43	32	32	170	30.48	38.10	ICSN-433	NLM46	CLM20	STCM11	S-46
MCLNL-3232M4D	9T27832M56D	CN_-43	32	32	170	30.48	38.10	ICSN-433	NLM46	CLM20	STCM11	S-46
MCLNR-2532M4D	9T28023M56D	CN_-43	25	32	170	30.48	31.75	ICSN-433	NLM46	CLM20	STCM11	S-46
MCLNL-2532M4D	9T27823M56D	CN_-43	25	32	170	30.48	31.75	ICSN-433	NLM46	CLM20	STCM11	S-46
MCLNR-2525M5D	9T28025M64D	CN_-54	25	25	150	34.80	31.75	ICSN-533	NLM58	CLM12	XNSC0825	S-58
MCLNL-2525M5D	9T27825M64D	CN_-54	25	25	150	34.80	31.75	ICSN-533	NLM58	CLM12	XNSC0825	S-58
MCLNR-3232M5D	9T28032M64D	CN_-54	32	32	170	34.80	38.10	ICSN-533	NLM58	CLM12	XNSC0825	S-58
MCLNL-3232M5D	9T27832M64D	CN_-54	32	32	170	34.80	38.10	ICSN-533	NLM58	CLM12	XNSC0825	S-58
MCLNR-2532M5D	9T28023M64D	CN_-54	25	32	170	34.80	31.75	ICSN-533	NLM58	CLM12	XNSC0825	S-58
MCLNL-2532M5D	9T27823M64D	CN_-54	25	32	170	34.80	31.75	ICSN-533	NLM58	CLM12	XNSC0825	S-58
MCLNR-2540M5E	9T28024M64E	CN_-54	25	40	250	34.80	31.75	ICSN-533	NLM58	CLM12	XNSC0825	S-58
MCLNL-2540M5E	9T27824M64E	CN_-54	25	40	250	34.80	31.75	ICSN-533	NLM58	CLM12	XNSC0825	S-58
MCLNR-2525M6D	9T28025M72D	CN_-64	25	25	150	37.85	31.75	ICSN-633	NLM68	CLM12	XNSC0825	S-68
MCLNL-2525M6D	9T27825M72D	CN_-64	25	25	150	37.85	31.75	ICSN-633	NLM68	CLM12	XNSC0825	S-68
MCLNR-3232M6D	9T28032M72D	CN_-64	32	32	150	37.85	38.10	ICSN-633	NLM68	CLM12	XNSC0825	S-68
MCLNL-3232M6D	9T27832M72D	CN_-64	32	32	150	37.85	38.10	ICSN-633	NLM68	CLM12	XNSC0825	S-68
MCLNR-4040M6E	9T28040M72E	CN_-64	40	40	250	37.85	50.80	ICSN-633	NLM68	CLM12	XNSC0825	S-68
MCLNL-4040M6E	9T27840M72E	CN_-64	40	40	250	37.85	50.80	ICSN-633	NLM68	CLM12	XNSC0825	S-68
MCLNR-2532M6D	9T28023M72D	CN_-64	25	32	170	37.85	50.80	ICSN-633	NLM68	CLM12	XNSC0825	S-68
MCLNL-2532M6D	9T27823M72D	CN_-64	25	32	170	37.85	50.80	ICSN-633	NLM68	CLM12	XNSC0825	S-68
MCLNR-2540M6E	9T28024M72E	CN_-64	25	40	250	37.85	50.80	ICSN-633	NLM68	CLM12	XNSC0825	S-68
MCLNL-2540M6E	9T27824M72E	CN_-64	25	40	250	37.85	50.80	ICSN-633	NLM68	CLM12	XNSC0825	S-68

MCMNN

50° Holder for 80° Diamond

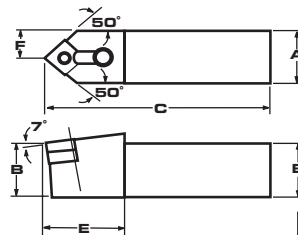

PARTS

Description	EDP Code	Insert	A	B	C	E	F	PARTS				
								Seat	Lock Pin	Clamp	Clamp Screw	Seat Screw
MCMNN-2525M4D	9T28225M56D	CN_-43	25	25	150	35.31	12.70	ICSN-433	NLM46	CLM20	STCM11	S-46
MCMNN-3232M6E	9T28232M72E	CN_-64	32	32	170	42.42	15.88	ICSN-633	NLM68	CLM12	XNSC0825	S-68

MCRNL/R

15° Holder for 80° Diamond

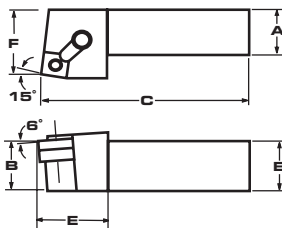

RH SHOWN

PARTS

Description	EDP Code	Insert	A	B	C	E	F	PARTS				
								Seat	Lock Pin	Clamp	Clamp Screw	Seat Screw
MCRNR-2020M4B	9T25220M56B	CN_-43	20	20	125	31.50	19.05	ICSN-433	NLM46	CLM9	STCM8	S-46
MCRNL-2020M4B	9T25020M56B	CN_-43	20	20	125	31.50	19.18	ICSN-433	NLM46	CLM9	STCM8	S-46
MCRNR-2525M4D	9T25225M56D	CN_-43	25	25	150	31.50	31.75	ICSN-433	NLM46	CLM9	STCM8	S-46
MCRNL-2525M4D	9T25025M56D	CN_-43	25	25	150	31.50	31.75	ICSN-433	NLM46	CLM9	STCM8	S-46
MCRNR-2525M5D	9T25225M64D	CN_-54	25	25	150	34.04	31.75	ICSN-533	NLM58	CLM9	XNSC0825	S-58
MCRNL-2525M5D	9T25025M64D	CN_-54	25	25	150	34.04	31.75	ICSN-533	NLM58	CLM9	XNSC0825	S-58
MCRNR-3232M5D	9T25232M64D	CN_-54	32	32	170	34.04	38.10	ICSN-533	NLM58	CLM9	XNSC0825	S-58
MCRNL-3232M5D	9T25032M64D	CN_-54	32	32	170	34.04	38.10	ICSN-533	NLM58	CLM9	XNSC0825	S-58
MCRNR-3232M6D	9T25232M72D	CN_-64	32	32	170	37.85	38.10	ICSN-633	NLM68	CLM12	XNSC0825	S-68
MCRNL-3232M6D	9T25032M72D	CN_-64	32	32	170	37.85	38.10	ICSN-633	NLM68	CLM12	XNSC0825	S-68
MCRNR-4040M6E	9T25240M72E	CN_-64	40	40	250	37.85	50.80	ICSN-633	NLM68	CLM12	XNSC0825	S-68
MCRNL-4040M6E	9T25040M72E	CN_-64	40	40	250	37.85	50.80	ICSN-633	NLM68	CLM12	XNSC0825	S-68



TURNING

MDJNL/R

5° Holder for 55° Diamond



RH SHOWN



PARTS

Description	EDP Code	Insert	A	B	C	E	F	PARTS				
								Seat	Lock Pin	Clamp	Clamp Screw	Seat Screw
MDJNR-2020M4B	9T29220M56B	DN_-43	20	20	125	35.05	25.40	IDSN-433	NLM46	CLM20	STCM11	S-46
MDJNL-2020M4B	9T29020M56B	DN_-43	20	20	125	35.05	25.40	IDSN-433	NLM46	CLM20	STCM11	S-46
MDJNR-2525M4D	9T29225M56D	DN_-43	25	25	150	31.50	31.75	IDSN-433	NLM46	CLM20	STCM11	S-46
MDJNL-2525M4D	9T29025M56D	DN_-43	25	25	150	31.50	31.75	IDSN-433	NLM46	CLM20	STCM11	S-46
MDJNR-3232M4D	9T29232M56D	DN_-43	32	32	150	31.50	38.10	IDSN-433	NLM46	CLM20	STCM11	S-46
MDJNL-3232M4D	9T29032M56D	DN_-43	32	32	150	31.50	38.10	IDSN-433	NLM46	CLM20	STCM11	S-46
MDJNR-2532M4D	9T29223M56D	DN_-43	25	32	150	31.50	31.75	IDSN-433	NLM46	CLM20	STCM11	S-46
MDJNL-2532M4D	9T29023M56D	DN_-43	25	32	150	31.50	31.75	IDSN-433	NLM46	CLM20	STCM11	S-46
MDJNR-2525M5D	9T29225M64D	DN_-54	25	25	150	37.34	31.75	IDSN-533	NLM58	CLM12	XNSC0825	S-58
MDJNL-2525M5D	9T29025M64D	DN_-54	25	25	150	37.34	31.75	IDSN-533	NLM58	CLM12	XNSC0825	S-58
MDJNR-3232M5D	9T29220M64D	DN_-54	32	32	150	37.34	31.75	IDSN-533	NLM58	CLM12	XNSC0825	S-58
MDJNL-3232M5D	9T29020M64D	DN_-54	32	32	150	37.34	31.75	IDSN-533	NLM58	CLM12	XNSC0825	S-58
MDJNR-2532M5D	9T29223M64D	DN_-54	25	32	150	37.34	38.10	IDSN-533	NLM58	CLM12	XNSC0825	S-58
MDJNL-2532M5D	9T29023M64D	DN_-54	25	32	150	37.34	38.10	IDSN-533	NLM58	CLM12	XNSC0825	S-58
MDJNR-2540M5E	9T29224M64E	DN_-54	25	40	250	37.34	31.75	IDSN-533	NLM58	CLM12	XNSC0825	S-58
MDJNL--2540M5E	9T29024M64E	DN_-54	25	40	250	37.34	31.75	IDSN-533	NLM58	CLM12	XNSC0825	S-58

MDPNN

27.5° Holder for 55° Diamond

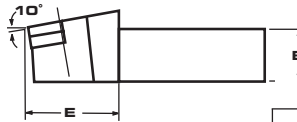
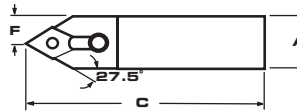

PARTS

Description	EDP Code	Insert	A	B	C	E	F	PARTS				
								Seat	Lock Pin	Clamp	Clamp Screw	Seat Screw
MDPNN-2525M4D	9T29625M56D	DN_-43	25	25	150	41.40	13.18	IDSN-433	NLM46	CLM12	XNSC0825	S-46
MDPNN-3232M4D	9T29632M56D	DN_-43	32	32	170	41.40	19.05	IDSN-433	NLM46	CLM12	XNSC0825	S-46
MDPNN-2525M5D	9T29625M64D	DN_-54	25	25	150	48.77	13.41	IDSN-533	NLM58	CLM12	XNSC0825	S-58
MDPNN-3232M5D	9T29632M64D	DN_-54	32	32	170	48.77	16.59	IDSN-533	NLM58	CLM12	XNSC0825	S-58
MDPNN-2532M5D	9T29623M64D	DN_-54	25	32	170	48.77	13.41	IDSN-533	NLM58	CLM12	XNSC0825	S-58

MRGNL/R

15° Holder for Round Insert

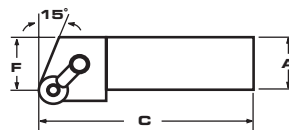

RH SHOWN

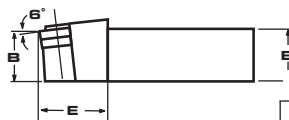

PARTS

Description	EDP Code	Insert	A	B	C	E	F	PARTS				
								Seat	Lock Pin	Clamp	Clamp Screw	Seat Screw
MRGNR-2525M4D	9T31425M56D	RN_-43	25	25	150	31.75	31.75	IRSN-433	NLM46	CLM20	STCM11	S-46
MRGNL-2525M4D	9T31225M56D	RN_-43	25	25	150	31.75	31.75	IRSN-433	NLM46	CLM20	STCM11	S-46
MRGNR-2525M5D	9T31425M64D	RN_-54	25	25	150	35.05	31.75	IRSN-533	NLM58	CLM12	XNSC0825	S-58
MRGNL-2525M5D	9T31225M64D	RN_-54	25	25	150	35.05	31.75	IRSN-533	NLM58	CLM12	XNSC0825	S-58
MRGNR-3232M5D	9T31432M64D	RN_-54	32	32	170	35.05	38.10	IRSN-533	NLM58	CLM12	XNSC0825	S-58
MRGNL-3232M5D	9T31232M64D	RN_-54	32	32	170	35.05	38.10	IRSN-533	NLM58	CLM12	XNSC0825	S-58
MRGNR-2525M6D	9T31425M72D	RN_-64	25	25	150	38.10	31.75	IRSN-633	NLM68	CLM9	XNSC0825	S-68
MRGNL-2525M6D	9T31225M72D	RN_-64	25	25	150	38.10	31.75	IRSN-633	NLM68	CLM9	XNSC0825	S-68
MRGNR-3232M6D	9T31432M72D	RN_-64	32	32	170	38.10	38.10	IRSN-633	NLM68	CLM9	XNSC0825	S-68
MRGNL-3232M6D	9T31232M72D	RN_-64	32	32	170	38.10	38.10	IRSN-633	NLM68	CLM9	XNSC0825	S-68



MSDNN 45° Holder for 90° Square

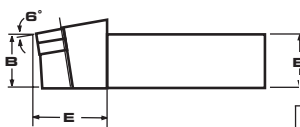
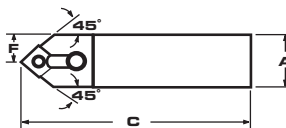

PARTS

Description	EDP Code	Insert	A	B	C	E	F	PARTS				
								Seat	Lock Pin	Clamp	Clamp Screw	Seat Screw
MSDNN-1616M3B	9T33016M48B	SN_-32	16	16	100	28.96	7.92	ISSN-322	NLM34L	CLM6	XNSM0515	S-34
MSDNN-2020M3B	9T33020M48B	SN_-32	20	20	125	28.96	9.53	ISSN-322	NLM34L	CLM6	XNSM0515	S-34
MSDNN-2020M4B	9T33020M56B	SN_-43	20	20	125	34.04	9.53	ISSN-433	NLM46	CLM9	STCM8	S-46
MSDNN-2525M4D	9T33025M56D	SN_-43	25	25	150	34.04	12.70	ISSN-433	NLM46	CLM9	STCM8	S-46
MSDNN-2525M5D	9T33025M64D	SN_-54	25	25	150	40.89	12.70	ISSN-533	NLM58	CLM12	XNSC0825	S-58
MSDNN-3232M5D	9T33032M64D	SN_-54	32	32	150	40.89	15.88	ISSN-533	NLM58	CLM12	XNSC0825	S-58
MSDNN-2532M5D	9T33023M64D	SN_-54	25	32	170	40.89	12.70	ISSN-533	NLM58	CLM12	XNSC0825	S-58
MSDNN-3232M6E	9T33032M72E	SN_-64	32	32	170	41.15	15.88	ISSN-633	NLM68	CLM12	XNSC0825	S-69
MSDNN-2540M6D	9T33024M72D	SN_-64	25	40	250	43.94	12.70	ISSN-633	NLM68	CLM12	XNSC0825	S-69
MSDNN-4040M8E	9T33040M83E	SN_-86	40	40	250	56.90	19.05	ISSN-844	NL-810	CLM24	XNSC0825	S-810
MSDNN-5050M8K	9T33050M83K	SN_-86	50	50	350	56.90	25.40	ISSN-844	NL-810	CLM24	XNSC0825	S-810

MSKNL/R 15° Holder for 90° Square

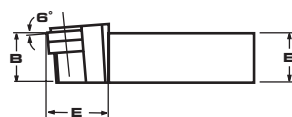

RH SHOWN

PARTS

Description	EDP Code	Insert	A	B	C	E	F	PARTS				
								Seat	Lock Pin	Clamp	Clamp Screw	Seat Screw
MSKNR-2020M3B	9T33620M48B	SN_-32	20	20	125	30.73	25.40	ISSN-322	NLM34L	CLM6	STCM9	S-34
MSKNL-2020M3B	9T33420M48B	SN_-32	20	20	125	30.73	25.40	ISSN-322	NLM34L	CLM6	STCM9	S-34
MSKNR-2020M4B	9T33620M56B	SN_-43	20	20	125	30.73	25.40	ISSN-433	NLM46	CLM9	STCM8	S-46
MSKNL-2020M4B	9T33420M56B	SN_-43	20	20	125	30.73	25.40	ISSN-433	NLM46	CLM9	STCM8	S-46
MSKNR-2525M4D	9T33625M56D	SN_-43	25	25	150	31.75	31.75	ISSN-433	NLM46	CLM9	STCM8	S-46
MSKNL-2525M4D	9T33425M56D	SN_-43	25	25	150	31.75	31.75	ISSN-433	NLM46	CLM9	STCM8	S-46
MSKNR-2525M5D	9T33625M64D	SN_-54	25	25	150	38.10	31.75	ISSN-533	NLM58	CLM12	XNSC0825	S-58
MSKNL-2525M5D	9T33425M64D	SN_-54	25	25	150	38.10	31.75	ISSN-533	NLM58	CLM12	XNSC0825	S-58
MSKNR-3232M5D	9T33632M64D	SN_-54	32	32	170	38.10	38.10	ISSN-533	NLM58	CLM12	XNSC0825	S-58
MSKNL-3232M5D	9T33432M64D	SN_-54	32	32	170	38.10	38.10	ISSN-533	NLM58	CLM12	XNSC0825	S-58
MSKNR-3232M6D	9T33632M72D	SN_-64	32	32	170	37.34	38.10	ISSN-633	NLM68	CLM24	STCM19	S-69
MSKNL-3232M6D	9T33432M72D	SN_-64	32	32	170	37.34	38.10	ISSN-633	NLM68	CLM24	STCM19	S-69
MSKNR-4040M6E	9T33640M72E	SN_-64	40	40	250	37.34	50.80	ISSN-633	NLM68	CLM24	STCM19	S-69
MSKNL-4040M6E	9T33440M72E	SN_-64	40	40	250	37.34	50.80	ISSN-633	NLM68	CLM24	STCM19	S-69

TURNING



TURNING

MSRNL/R

15° Holder for 90° Square

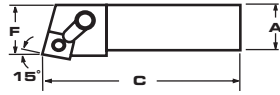

RH SHOWN

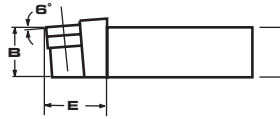

PARTS

Description	EDP Code	Insert	A	B	C	E	F	PARTS				
								Seat	Lock Pin	Clamp	Clamp Screw	Seat Screw
MSRNR-1212M3B	9T34212M48B	SN_-32	12	12	100	26.16	16.71	ISSN-322	NLM34L	CLM6	XNSM0515	S-46
MSRNL-1212M3B	9T34012M48B	SN_-32	12	12	100	26.16	16.71	ISSN-322	NLM34L	CLM6	XNSM0515	S-46
MSRNR-2020M4B	9T34220M56B	SN_-43	20	20	125	31.75	22.30	ISSN-433	NLM46	CLM9	XNSM0825	S-46
MSRNL-2020M4B	9T34020M56B	SN_-43	20	20	125	31.75	22.30	ISSN-433	NLM46	CLM9	XNSM0825	S-46
MSRNR-2525M4D	9T34225M56D	SN_-43	25	25	150	31.75	28.65	ISSN-433	NLM46	CLM9	XNSM0825	S-46
MSRNL-2525M4D	9T34025M56D	SN_-43	25	25	150	31.75	28.65	ISSN-433	NLM46	CLM9	XNSM0825	S-46
MSRNR-2525M5D	9T34225M64D	SN_-54	25	25	150	36.58	27.94	ISSN-533	NLM58	CLM12	XNSM0825	S-58
MSRNL-2525M5D	9T34025M64D	SN_-54	25	25	150	36.58	27.94	ISSN-533	NLM58	CLM12	XNSM0825	S-58
MSRNR-3232M5D	9T34232M64D	SN_-54	32	32	170	36.58	34.29	ISSN-533	NLM58	CLM12	XNSM0825	S-58
MSRNL-3232M5D	9T34032M64D	SN_-54	32	32	170	36.58	34.29	ISSN-533	NLM58	CLM12	XNSM0825	S-58
MSRNR-2532M5D	9T34223M64D	SN_-54	25	32	170	37.08	27.94	ISSN-533	NLM58	CLM12	XNSM0825	S-58
MSRNL-2532M5D	9T34023M64D	SN_-54	25	32	170	37.08	27.94	ISSN-533	NLM58	CLM12	XNSM0825	S-58
MSRNR-3232M6D	9T34232M72D	SN_-64	32	32	170	39.62	33.48	ISSN-633	NLM68	CLM12	XNSM0825	S-68
MSRNL-3232M6D	9T34032M72D	SN_-64	32	32	170	39.62	33.48	ISSN-633	NLM68	CLM12	XNSM0825	S-68
MSRNR-4040M6E	9T34240M72E	SN_-64	40	40	250	39.62	46.18	ISSN-633	NLM68	CLM12	XNSM0825	S-68
MSRNL-4040M6E	9T34040M72E	SN_-64	40	40	250	39.62	46.18	ISSN-633	NLM68	CLM12	XNSM0825	S-68
MSRNR-2532M6D	9T34223M72E	SN_-64	25	32	170	38.10	27.13	ISSN-633	NLM68	CLM12	XNSM0825	S-68
MSRNL-2532M6D	9T34023M72E	SN_-64	25	32	170	38.10	27.13	ISSN-633	NLM68	CLM12	XNSM0825	S-68
MSRNR-5050M8K	9T34250M83K	SN_-86	50	50	350	41.15	57.45	ISSN-844	NL-810	CLM24	STCM19	S-810
MSRNL-5050M8K	9T34050M83K	SN_-86	50	50	350	41.15	57.45	ISSN-844	NL-810	CLM24	STCM19	S-810

MSSNL/R

45° Holder for 90° Square

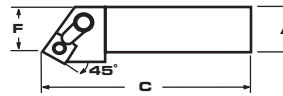

RH SHOWN

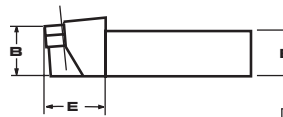

PARTS

Description	EDP Code	Insert	A	B	C	E	F	PARTS				
								Seat	Lock Pin	Clamp	Clamp Screw	Seat Screw
MSSNR-1212M3B	9T34812M48B	SN_-32	12	12	100	26.16	16.71	ISSN-322	NLM34L	CLM6	XNSM0515	S-46
MSSNL-1212M3B	9T34612M48B	SN_-32	12	12	100	26.16	16.71	ISSN-322	NLM34L	CLM6	XNSM0515	S-46
MSSNR-2020M4B	9T34820M56B	SN_-43	20	20	125	31.50	16.81	ISSN-433	NLM46	CLM9	STCM8	S-46
MSSNL-2020M4B	9T34620M56B	SN_-43	20	20	125	31.50	16.81	ISSN-433	NLM46	CLM9	STCM8	S-46
MSSNR-2525M4D	9T34825M56D	SN_-43	25	25	150	31.50	23.16	ISSN-433	NLM46	CLM9	STCM8	S-46
MSSNL-2525M4D	9T34625M56D	SN_-43	25	25	150	31.50	23.16	ISSN-433	NLM46	CLM9	STCM8	S-46
MSSNR-2525M5D	9T34825M64D	SN_-54	25	25	150	34.80	23.16	ISSN-533	NLM58	CLM12	XNSM0825	S-58
MSSNL-2525M5D	9T34625M64D	SN_-54	25	25	150	34.80	23.16	ISSN-533	NLM58	CLM12	XNSM0825	S-58
MSSNR-3232M5D	9T34832M64D	SN_-54	32	32	170	34.80	38.10	ISSN-533	NLM58	CLM12	XNSM0825	S-58
MSSNL-3232M5D	9T34632M64D	SN_-54	32	32	170	34.80	38.10	ISSN-533	NLM58	CLM12	XNSM0825	S-58
MSSNR-2532M5D	9T34823M64D	SN_-54	25	32	170	34.80	31.75	ISSN-533	NLM58	CLM12	XNSM0825	S-58
MSSNL-2532M5D	9T34623M64D	SN_-54	25	32	170	34.80	31.75	ISSN-533	NLM58	CLM12	XNSM0825	S-58
MSSNR-3232M6D	9T34832M72D	SN_-64	32	32	170	37.85	38.10	ISSN-633	NLM68	CLM12	XNSM0825	S-68
MSSNL-3232M6D	9T34632M72D	SN_-64	32	32	170	37.85	38.10	ISSN-633	NLM68	CLM12	XNSM0825	S-68
MSSNR-4040M6E	9T34840M72E	SN_-64	40	40	250	37.85	50.80	ISSN-633	NLM68	CLM12	XNSM0825	S-68
MSSNL-4040M6E	9T34640M72E	SN_-64	40	40	250	37.85	50.80	ISSN-633	NLM68	CLM12	XNSM0825	S-68
MSSNR-2532M6D	9T34823M72E	SN_-64	25	32	170	37.85	50.80	ISSN-633	NLM68	CLM12	XNSM0825	S-68
MSSNL-2532M6D	9T34623M72E	SN_-64	25	32	170	37.85	50.80	ISSN-633	NLM68	CLM12	XNSM0825	S-68
MSSNR-5050M8K	9T34850M83K	SN_-86	50	50	350	41.15	57.45	ISSN-844	NL-810	CLM24	STCM19	S-810
MSSNL-5050M8K	9T34650M83K	SN_-86	50	50	350	41.15	57.45	ISSN-844	NL-810	CLM24	STCM19	S-810

TURNING



MTANL/R

5° Holder for 60° Triangle

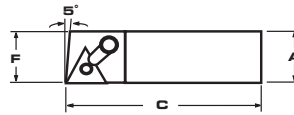

RH SHOWN

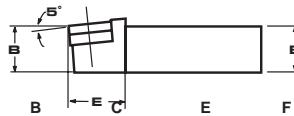

PARTS

Description	EDP Code	Insert	A	B	C	E	F	PARTS				
								Seat	Lock Pin	Clamp	Clamp Screw	Seat Screw
MTANR-2020M3A	9T35420M48B	TN_-32	20	20	125	26.92	19.05	ITSN-322	NLM34L	CLM6	XNSM0515	S-34
MTANL-2020M3A	9T35220M48B	TN_-32	20	20	125	26.92	19.05	ITSN-322	NLM34L	CLM6	XNSM0515	S-34
MTANR-2525M4D	9T35425M56D	TN_-43	25	25	150	30.99	25.40	ITSN-433	NLM46	CLM9	XNS-59	S-46
MTANL-2525M4D	9T35225M56D	TN_-43	25	25	150	30.99	25.40	ITSN-433	NLM46	CLM9	XNS-59	S-46

MTCNN

0° Holder for 60° Triangle

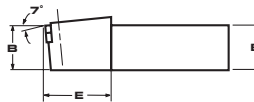
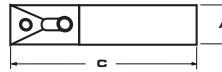

PARTS

Description	EDP Code	Insert	A	B	C	E	F	PARTS				
								Seat	Lock Pin	Clamp	Clamp Screw	Seat Screw
MTCNN-1212M3F	9T36412M49F	TN_-33	12	12	200	28.70	N/A	ITSN-323	NLM34L	CLM7	XNSM0515	S-46
MTCNN-2020M4D	9T36420M56D	TN_-43	20	20	150	36.32	N/A	ITSN-433	NLM46	CLM12	XNSM0825	S-46
MTCNN-2025M4F	9T36422M56F	TN_-43	20	25	200	36.32	N/A	ITSN-433	NLM46	CLM12	XNSM0825	S-46

MTENNS

60° Holder for 60° Triangle

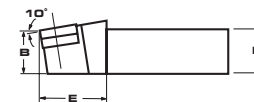

PARTS

Description	EDP Code	Insert	A	B	C	E	F	PARTS				
								Seat	Lock Pin	Clamp	Clamp Screw	Seat Screw
MTENNS-1616M3B	9T36816M49B	TN_-33	16	16	100	29.46	7.92	ITSN-323	NLM34L	CLM6	XNSM0515	N/A
MTENNS-2020M3B	9T36820M49B	TN_-33	20	20	125	29.46	9.53	ITSN-323	NLM34L	CLM6	XNSM0515	N/A
MTENNS-2532M3D	9T36823M49D	TN_-33	25	32	170	29.46	12.70	ITSN-323	NLM34L	CLM6	XNSM0515	N/A
MTENNS-1616M4B	9T36816M56B	TN_-43	16	16	100	28.96	7.92	ITSN-433	NLM46	CLM9	XNSM0825	N/A
MTENNS-2020M4B	9T36820M56B	TN_-43	20	20	125	38.10	9.53	ITSN-433	NLM46	CLM9	XNSM0825	N/A
MTENNS-2525M4D	9T36825M56B	TN_-43	25	25	150	38.10	12.70	ITSN-433	NLM46	CLM9	XNSM0825	N/A
MTENNS-2532M4D	9T36823M56D	TN_-43	25	32	170	38.10	12.70	ITSN-433	NLM46	CLM9	XNSM0825	N/A
MTENNS-2540M4E	9T36824M56E	TN_-43	25	40	250	38.10	12.70	ITSN-433	NLM46	CLM9	XNSM0825	N/A
MTENNS-3232M5D	9T36832M64D	TN_-54	32	32	170	41.66	15.88	ITSN-533	NLM58	CLM9	XNSM0825	N/A
MTENNS-4040M6E	9T36840M76E	TN_-64	40	40	250	49.53	19.05	ITSN-636	NLM68	CLM12	XNSM0825	N/A

MTFNL/R

90° Holder for 60° Triangle



RH SHOWN



PARTS

Description	EDP Code	Insert	A	B	C	E	F	PARTS				
								Seat	Lock Pin	Clamp	Clamp Screw	Seat Screw
MTFNR-2020M3B	9T37420M49B	TN_-33	20	20	125	23.88	25.40	ITSN-323	NLM34L	CLM6	XNSM0515	S-46
MTFNL-2020M3B	9T37220M49B	TN_-33	20	20	125	23.88	25.40	ITSN-323	NLM34L	CLM6	XNSM0515	S-46
MTFNR-2525M63C	9T37425M49C	TN_-33	25	25	150	23.88	31.75	ITSN-323	NLM34L	CLM6	XNSM0515	S-46
MTFNL-2525M3C	9T37225M49C	TN_-33	25	25	150	23.88	31.75	ITSN-323	NLM34L	CLM6	XNSM0515	S-46
MTFNR-2525M4D	9T37425M56D	TN_-43	25	25	150	30.99	31.75	ITSN-433	NLM46	CLM9	XNSM0825	S-46
MTFNL-2525M4D	9T37225M56D	TN_-43	25	25	150	30.99	31.75	ITSN-433	NLM46	CLM9	XNSM0825	S-46
MTFNR-3232M4D	9T37432M56D	TN_-43	32	32	170	30.99	38.10	ITSN-433	NLM46	CLM9	XNSM0825	S-46
MTFNL-3232M4D	9T37232M56D	TN_-43	32	32	170	30.99	38.10	ITSN-433	NLM46	CLM9	XNSM0825	S-46
MTFNR-2532M4D	9T37423M56D	TN_-43	25	32	170	30.99	31.75	ITSN-433	NLM46	CLM9	XNSM0825	S-46
MTFNL-2532M4D	9T37223M56D	TN_-43	25	32	170	30.99	31.75	ITSN-433	NLM46	CLM9	XNSM0825	S-46
MTFNR-2525M5D	9T37425M64D	TN_-54	25	25	150	36.32	31.75	ITSN-533	NLM58	CLM12	XNSM0825	S-58
MTFNL-2525M5D	9T37225M64D	TN_-54	25	25	150	36.32	31.75	ITSN-533	NLM58	CLM12	XNSM0825	S-58
MTFNR-3232M5D	9T37432M64D	TN_-54	32	32	170	36.32	38.10	ITSN-533	NLM58	CLM12	XNSM0825	S-58
MTFNL-3232M5D	9T37232M64D	TN_-54	32	32	170	36.32	38.10	ITSN-533	NLM58	CLM12	XNSM0825	S-58
MTFNR-2532M5D	9T37423M64D	TN_-54	25	32	170	36.32	31.75	ITSN-533	NLM58	CLM12	XNSM0825	S-58
MTFNL-2532M5D	9T37223M64D	TN_-54	25	32	170	36.32	31.75	ITSN-533	NLM58	CLM12	XNSM0825	S-58
MTFNR-4040M6E	9T37440M76E	TN_-66	40	40	250	37.85	31.75	ITSN-633	NLM68	CLM12	XNSM0825	S-68
MTFNL-4040M6E	9T37240M76E	TN_-66	40	40	250	37.85	50.80	ITSN-633	NLM68	CLM12	XNSM0825	S-68



TURNING

MTGNL/R

90° Holder for 60° Triangle

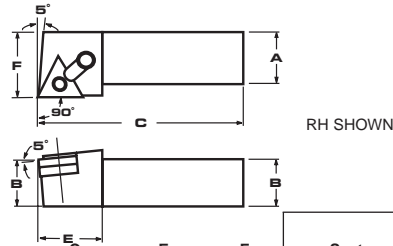

PARTS

Description	EDP Code	Insert	A	B	C	E	F	Seat	Lock Pin	Clamp	Clamp Screw	Seat Screw
MTGNR-2020M3B	9T38020M49B	TN_-33	20	20	125	28.45	25.40	ITSN-323	NLM34L	CLM6	XNSM0515	S-34
MTGNL-2020M3B	9T37820M49B	TN_-33	20	20	125	28.45	25.40	ITSN-323	NLM34L	CLM6	XNSM0515	S-34
MTGNR-2525M3C	9T38025M49C	TN_-33	25	25	150	28.45	31.75	ITSN-323	NLM34L	CLM6	XNSM0515	S-46
MTGNL-25253C	9T37825M49C	TN_-33	25	25	150	28.45	31.75	ITSN-323	NLM34L	CLM6	XNSM0515	S-46
MTGNR-25254D	9T38025M56D	TN_-43	25	25	150	30.99	31.75	ITSN-433	NLM46	CLM9	XNSM0825	S-46
MTGNL-25254D	9T37825M56D	TN_-43	25	25	150	30.99	31.75	ITSN-433	NLM46	CLM9	XNSM0825	S-46
MTGNR-3232M4D	9T38032M56D	TN_-43	32	32	170	30.99	38.10	ITSN-433	NLM46	CLM9	XNSM0825	S-46
MTGNL-3232M4D	9T37832M56D	TN_-43	32	32	170	30.99	38.10	ITSN-433	NLM46	CLM9	XNSM0825	S-46
MTGNR-2532M4D	9T38023M56D	TN_-43	25	32	170	30.99	31.75	ITSN-433	NLM46	CLM9	XNSM0825	S-46
MTGNL-2532M4D	9T37823M56D	TN_-43	25	32	170	30.99	31.75	ITSN-433	NLM46	CLM9	XNSM0825	S-46
MTGNR-25255D	9T38025M64D	TN_-54	25	25	150	36.32	31.75	ITSN-533	NLM58	CLM12	XNSM0825	S-58
MTGNL-25255D	9T37825M64D	TN_-54	25	25	150	36.32	31.75	ITSN-533	NLM58	CLM12	XNSM0825	S-58
MTGNR-3232M5D	9T38032M64D	TN_-54	32	32	170	36.32	38.10	ITSN-533	NLM58	CLM12	XNSM0825	S-58
MTGNL-3232M5D	9T37832M64D	TN_-54	32	32	170	36.32	38.10	ITSN-533	NLM58	CLM12	XNSM0825	S-58
MTGNR-2532M5D	9T38023M64D	TN_-54	25	32	170	36.32	31.75	ITSN-533	NLM58	CLM12	XNSM0825	S-58
MTGNL-2532M5D	9T37823M64D	TN_-54	25	32	170	36.32	31.75	ITSN-533	NLM58	CLM12	XNSM0825	S-58
MTGNR-4040M6E	9T38040M72E	TN_-66	40	40	250	37.85	31.75	ITSN-633	NLM68	CLM12	XNSM0825	S-68
MTGNL-4040M6E	9T37840M72E	TN_-66	40	40	250	37.85	50.80	ITSN-633	NLM68	CLM12	XNSM0825	S-68

MTJNLS/RS

3° Holder for 60° Triangle

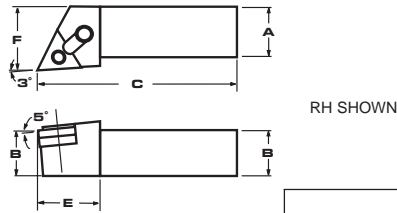

PARTS

Description	EDP Code	Insert	A	B	C	E	F	Seat	Lock Pin	Clamp	Clamp Screw	Seat Screw
MTJNRS-123B	9T38620M49B	TN_-33	20	20	125	28.45	25.40	ITSN-323	NLM34L	CLM6	XNSM0515	N/A
MTJNLS-123B	9T38420M49B	TN_-33	20	20	125	28.45	25.40	ITSN-323	NLM34L	CLM6	XNSM0515	N/A
MTJNRS-164D	9T38625M56D	TN_-43	25	25	150	30.23	31.75	ITSN-433	NLM46	CLM9	XNSM0825	N/A
MTJNLS-164D	9T38425M56D	TN_-43	25	25	150	30.23	31.75	ITSN-433	NLM46	CLM9	XNSM0825	N/A
MTJNRS-204D	9T38632M56D	TN_-43	32	32	170	30.23	38.10	ITSN-433	NLM46	CLM9	XNSM0825	N/A
MTJNLS-204D	9T38432M56D	TN_-43	32	32	170	30.23	38.10	ITSN-433	NLM46	CLM9	XNSM0825	N/A
MTJNRS-854D	9T38623M56D	TN_-43	25	32	170	30.23	31.75	ITSN-433	NLM46	CLM9	XNSM0825	N/A
MTJNLS-854D	9T38423M56D	TN_-43	25	32	170	30.23	31.75	ITSN-433	NLM46	CLM9	XNSM0825	N/A
MTJNRS-864E	9T38624M56E	TN_-43	25	40	250	30.23	31.75	ITSN-433	NLM46	CLM9	XNSM0825	N/A
MTJNLS-864E	9T38424M56E	TN_-43	25	40	250	30.23	31.75	ITSN-433	NLM46	CLM9	XNSM0825	N/A
MTJNRS-205D	9T38632M64D	TN_-54	32	32	170	36.58	38.10	ITSN-533	NLM58	CLM9	XNSM0825	N/A
MTJNLS-205D	9T38432M64D	TN_-54	32	32	170	36.58	38.10	ITSN-533	NLM58	CLM9	XNSM0825	N/A
MTJNRS-865D	9T38624M64D	TN_-54	25	40	250	36.58	31.75	ITSN-533	NLM58	CLM9	XNSM0825	N/A
MTJNLS-865D	9T38424M64D	TN_-54	25	40	250	36.58	31.75	ITSN-533	NLM58	CLM9	XNSM0825	N/A
MTJNRS-246E	9T38640M72E	TN_-66	40	40	250	42.42	50.80	ITSN-633	NLM68	CLM12	XNSM0825	N/A
MTJNLS-246E	9T38440M72E	TN_-66	40	40	250	42.42	50.80	ITSN-633	NLM68	CLM12	XNSM0825	N/A

MTLNL/R

5° Holder for 60° Triangle

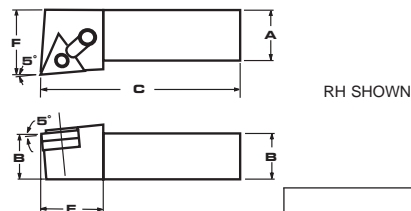

PARTS

Description	EDP Code	Insert	A	B	C	E	F	Seat	Lock Pin	Clamp	Clamp Screw	Seat Screw
MTLNR-123B	9T39220M49B	TN_-33	20	20	125	28.45	25.40	ITSN-323	NLM34L	CLM6	XNSM0515	N/A
MTLNL-123B	9T39020M49B	TN_-33	20	20	125	28.45	25.40	ITSN-323	NLM34L	CLM6	XNSM0515	N/A
MTLNR-163D	9T39225M49D	TN_-33	25	25	150	28.45	31.75	ITSN-323	NLM34L	CLM6	XNSM0515	N/A
MTLNL-163D	9T39025M49D	TN_-33	25	25	150	28.45	31.75	ITSN-323	NLM34L	CLM6	XNSM0515	N/A
MTLNR-164D	9T39225M56D	TN_-43	25	25	150	31.50	31.75	ITSN-433	NLM46	CLM9	XNSM0825	S-46
MTLNL-164D	9T39025M56D	TN_-43	25	25	150	31.50	31.75	ITSN-433	NLM46	CLM9	XNSM0825	S-46
MTLNR-204D	9T39232M56D	TN_-43	32	32	170	32.51	38.10	ITSN-433	NLM46	CLM9	XNSM0825	S-46
MTLNL-204D	9T39032M56D	TN_-43	32	32	170	32.51	38.10	ITSN-433	NLM46	CLM9	XNSM0825	S-46
MTLNR-205D	9T39232M64D	TN_-54	32	32	170	35.56	38.10	ITSN-533	NLM58	CLM9	XNSM0825	S-58
MTLNL-205D	9T39032M64D	TN_-54	32	32	170	35.56	38.10	ITSN-533	NLM58	CLM9	XNSM0825	S-58



MTRNL/R

15° Holder for 60° Triangle

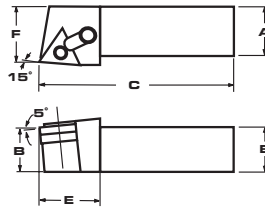

RH SHOWN

PARTS

Description	EDP Code	Insert	A	B	C	E	F	PARTS				
								Seat	Lock Pin	Clamp	Clamp Screw	Seat Screw
MTRNR-2020M3B	9T39820M49B	TN__-33	20	20	125	30.48	21.51	ITSN-323	NLM34L	CLM20	STCM11	S-34
MTRNL-2020M3B	9T39620M49B	TN__-33	20	20	125	30.48	21.51	ITSN-323	NLM34L	CLM20	STCM11	S-34
MTRNR-2525M3D	9T39825M49D	TN__-33	25	25	150	30.48	27.86	ITSN-323	NLM34L	CLM20	STCM11	S-34
MTRNL-2525M3D	9T39625M49D	TN__-33	25	25	150	30.48	27.86	ITSN-323	NLM34L	CLM20	STCM11	S-34
MTRNR-2525M4D	9T39825M56D	TN__-43	25	25	150	31.50	26.42	ITSN-433	NLM46	CLM9	XNSM0825	S-46
MTRNL-2525M4D	9T39625M56D	TN__-43	25	25	150	31.50	26.42	ITSN-433	NLM46	CLM9	XNSM0825	S-46
MTRNR-2525M5D	9T39825M64D	TN__-54	25	25	150	41.15	25.15	ITSN-533	NLM58	CLM9	XNSM0825	S-58
MTRNL-2525M5D	9T39625M64D	TN__-54	25	25	150	41.15	25.15	ITSN-533	NLM58	CLM9	XNSM0825	S-58
MTRNR-3232M5D	9T39832M64D	TN__-54	32	32	170	41.15	31.50	ITSN-533	NLM58	CLM9	XNSM0825	S-58
MTRNL-3232M5D	9T39632M64D	TN__-54	32	32	150	41.15	31.50	ITSN-533	NLM58	CLM9	XNSM0825	S-58
MTRNR-4040M6E	9T39840M72E	TN__-66	40	40	250	42.67	42.80	ITSN-633	NLM68	CLM12	XNSM0825	S-68
MTRNL-4040M6E	9T39640M72E	TN__-66	40	40	250	42.67	42.80	ITSN-633	NLM68	CLM12	XNSM0825	S-68

MTWNL/R

10° Holder for 60° Triangle

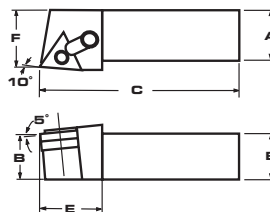

RH SHOWN

PARTS

Description	EDP Code	Insert	A	B	C	E	F	PARTS				
								Seat	Lock Pin	Clamp	Clamp Screw	Seat Screw
MTWNR-2020M3D	9T41420M49D	TN__-33	20	20	150	34.29	22.23	ITSN-323	NLM34L	CLM6	XNSM0515	S-34
MTWNL-2020M3D	9T41020M49D	TN__-33	20	20	150	34.29	22.23	ITSN-323	NLM34L	CLM6	XNSM0515	S-34
MTWNR-2525M4E	9T41425M56E	TN__-43	25	25	170	44.45	27.79	ITSN-433	NLM46	CLM9	XNSM0825	S-46
MTWNL-2525M4E	9T41025M56E	TN__-43	25	25	170	44.45	27.79	ITSN-433	NLM46	CLM9	XNSM0825	S-46
MTWNR-3232M5F	9T41432M64F	TN__-54	32	32	200	46.74	33.32	ITSN-533	NLM58	CLM9	XNSM0825	S-58
MTWNL-3232M5F	9T41032M64F	TN__-54	32	32	200	46.74	33.32	ITSN-533	NLM58	CLM9	XNSM0825	S-58

MVJNL/R

3° Holder for 35° Diamond

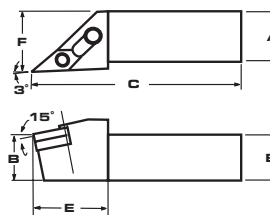

RH SHOWN

PARTS

Description	EDP Code	Insert	A	B	C	E	F	PARTS				
								Seat	Lock Pin	Clamp	Clamp Screw	Seat Screw
MVJNR-2020M3B	9T42220M49B	VN__-33	20	20	125	42.16	25.40	IVSN-322	NLM34L	CLM30	XNSM0515	S-34
MVJNL-2020M3B	9T41820M49B	VN__-33	20	20	125	42.16	25.40	IVSN-322	NLM34L	CLM30	XNSM0515	S-34
MVJNR-2525M3C	9T42225M49C	VN__-33	25	25	150	42.16	31.75	IVSN-322	NLM34L	CLM30	XNSM0515	S-34
MVJNL-2525M3C	9T41825M49C	VN__-33	25	25	150	42.16	31.75	IVSN-322	NLM34L	CLM30	XNSM0515	S-34
MVJNR-3232M3D	9T42232M49D	VN__-33	32	32	170	42.16	38.10	IVSN-322	NLM34L	CLM30	XNSM0825	S-34
MVJNL-3232M3D	9T41832M49D	VN__-33	32	32	170	42.16	38.10	IVSN-322	NLM34L	CLM30	XNSM0825	S-34
MVJNR-2532M3D	9T42223M49D	VN__-33	25	32	170	42.16	31.75	IVSN-322	NLM34L	CLM30	XNSM0825	S-34
MVJNL-2532M3D	9T41823M49D	VN__-33	25	32	170	42.16	31.75	IVSN-322	NLM34L	CLM30	XNSM0825	S-34
MVJNR-2525M4D	9T42225M56D	VN__-43	25	25	150	50.80	31.75	IVSN-433	NLM46	CLM30	XNSM0825	S-46
MVJNL-2525M4D	9T41825M56D	VN__-43	25	25	150	50.80	31.75	IVSN-433	NLM46	CLM30	XNSM0825	S-46
MVJNR-3232M4D	9T42232M56D	VN__-43	32	32	170	50.80	38.10	IVSN-433	NLM46	CLM30	XNSM0825	S-46
MVJNL-3232M4D	9T41832M56D	VN__-43	32	32	170	50.80	38.10	IVSN-433	NLM46	CLM30	XNSM0825	S-46
MVJNR-2540M4E	9T42224M56E	VN__-43	25	40	200	50.80	31.75	IVSN-433	NLM46	CLM30	XNSM0825	S-46
MVJNL-2540M4E	9T41824M56E	VN__-43	25	40	200	50.80	31.75	IVSN-433	NLM46	CLM30	XNSM0825	S-46



TURNING

MVLNL/R

5° Holder for 35° Diamond

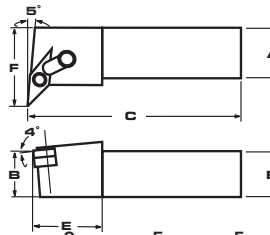

RH SHOWN

PARTS

Description	EDP Code	Insert	A	B	C	E	F	Seat	Lock Pin	Clamp	Clamp Screw	Seat Screw
MVLNR-2525M4D	9T42825M56D	VN_-43	25	25	150	38.10	44.45	IVSN-433	NLM46	CLM12	XNSM0825	S-46
MVLNL-2525M4D	9T42625M56D	VN_-43	25	25	150	38.10	44.45	IVSN-433	NLM46	CLM12	XNSM0825	S-46
MVLNR-3232M4D	9T42832M56D	VN_-43	32	32	170	38.10	50.80	IVSN-433	NLM46	CLM12	XNSM0825	S-46
MVLNL-3232M4D	9T42632M56D	VN_-43	32	32	170	38.10	50.80	IVSN-433	NLM46	CLM12	XNSM0825	S-46

MVNNL/R

27.5° Holder for 35° Diamond

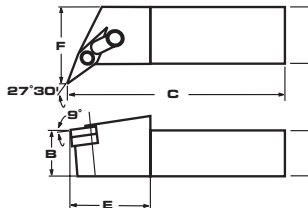

RH SHOWN

PARTS

Description	EDP Code	Insert	A	B	C	E	F	Seat	Lock Pin	Clamp	Clamp Screw	Seat Screw
MVNNR-2020M3B	9T43420M49B	VN_-33	20	20	125	23.88	25.40	IVSN-322	NLM34L	CLM6	XNSM0515	S-34
MVNNL-2020M3B	9T43220M49B	VN_-33	20	20	125	23.88	25.40	IVSN-322	NLM34L	CLM6	XNSM0515	S-34
MVNNR-2525M3D	9T43425M49D	VN_-33	25	25	150	30.99	31.75	IVSN-322	NLM34L	CLM6	XNSM0515	S-34
MVNNL-2525M3D	9T43225M49D	VN_-33	25	25	150	30.99	31.75	IVSN-322	NLM34L	CLM6	XNSM0515	S-34
MVNNR-3232M3D	9T43432M49D	VN_-33	32	32	170	30.99	38.10	IVSN-322	NLM34L	CLM6	XNSM0515	S-34
MVNNL-3232M3D	9T43232M49D	VN_-33	32	32	170	30.99	38.10	IVSN-322	NLM34L	CLM6	XNSM0515	S-34

MVTNL/R

27.5° Holder for 35° Diamond

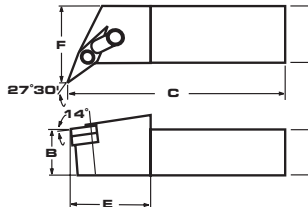

RH SHOWN

PARTS

Description	EDP Code	Insert	A	B	C	E	F	Seat	Lock Pin	Clamp	Clamp Screw	Seat Screw
MVTNR-2020M3B	9T44620M49B	VN_-33	20	20	125	43.43	25.40	IVSN-322	NLM34L	CLM30	XNSM0825	S-34
MVTNL-2020M3B	9T44420M49B	VN_-33	20	20	125	43.43	25.40	IVSN-322	NLM34L	CLM30	XNSM0825	S-34
MVTNR-2525M3D	9T44625M49D	VN_-33	25	25	150	43.43	31.75	IVSN-322	NLM34L	CLM30	XNSM0825	S-34
MVTNL-2525M3D	9T44425M49D	VN_-33	25	25	150	43.43	31.75	IVSN-322	NLM34L	CLM30	XNSM0825	S-34
MVTNR-3232M3D	9T44632M49D	VN_-33	32	32	170	43.43	38.10	IVSN-322	NLM34L	CLM30	XNSM0825	S-34
MVTNL-3232M3D	9T44432M49D	VN_-33	32	32	170	43.43	38.10	IVSN-322	NLM34L	CLM30	XNSM0825	S-34
MVTNR-4040M3E	9T44640M49E	VN_-33	40	40	250	43.43	44.45	IVSN-322	NLM34L	CLM30	XNSM0825	S-34
MVTNL-4040M3E	9T44440M49E	VN_-33	40	40	250	43.43	44.45	IVSN-322	NLM34L	CLM30	XNSM0825	S-34

MWLNL/R

5° Holder for 80° Trigon

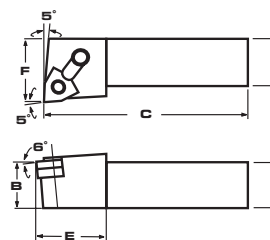

RH SHOWN

PARTS

Description	EDP Code	Insert	A	B	C	E	F	Seat	Lock Pin	Clamp	Clamp Screw	Seat Screw
MWLNR-2020M3B	9T45620M49B	WN_-33	20	20	125	30.48	25.40	IWSN-322	NLM34L	CLM6	XNSM0515	N/A
MWLNL-2020M3B	9T45420M49B	WN_-33	20	20	125	30.48	25.40	IWSN-322	NLM34L	CLM6	XNSM0515	N/A
MWLNR-2525M3D	9T45625M49D	WN_-33	25	25	150	30.48	31.75	IWSN-322	NLM34L	CLM6	XNSM0515	N/A
MWLNL-2525M3D	9T45425M49D	WN_-33	25	25	150	30.48	31.75	IWSN-322	NLM34L	CLM6	XNSM0515	N/A
MWLNR-3232M3D	9T45632M49D	WN_-33	32	32	170	30.48	38.10	IWSN-322	NLM34L	CLM6	XNSM0515	N/A
MWLNL-3232M3D	9T45432M49D	WN_-33	32	32	170	30.48	38.10	IWSN-322	NLM34L	CLM6	XNSM0515	N/A
MWLNR-2020M4B	9T45620M56B	WN_-43	20	20	125	30.48	25.40	IWSN-433	NLM46	CLM20	STCM11	N/A
MWLNL-2020M4B	9T45420M56B	WN_-43	20	20	125	30.48	25.40	IWSN-433	NLM46	CLM20	STCM11	N/A
MWLNR-2525M4D	9T45625M56D	WN_-43	25	25	150	30.48	31.75	IWSN-433	NLM46	CLM20	STCM11	N/A
MWLNL-2525M4D	9T45425M56D	WN_-43	25	25	150	30.48	31.75	IWSN-433	NLM46	CLM20	STCM11	N/A
MWLNR-3232M4D	9T45632M56D	WN_-43	32	32	170	30.48	38.10	IWSN-433	NLM46	CLM20	STCM11	N/A
MWLNL-3232M4D	9T45432M56D	WN_-43	32	32	170	30.48	38.10	IWSN-433	NLM46	CLM20	STCM11	N/A



RAL/R

45° Holder for Round Insert

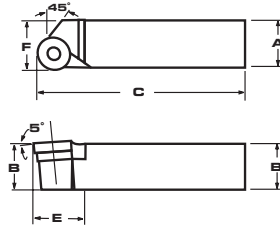

RH SHOWN

PARTS

Description	EDP Code	Insert	A	B	C	E	F	PARTS		
								Seat	Cam Pin	Seat Screw
RAR-2525M4	9T51225M56	RN_-43	25	25	150	17.53	25.40	RSN-43	CLP-38	N/A
RAL-2525M4	9T51125M56	RN_-43	25	25	150	17.53	25.40	RSN-43	CLP-38	N/A
RAR-2532M4	9T51223M56	RN_-43	25	32	170	17.53	25.40	RSN-43	CLP-310	N/A
RAL-2532M4	9T51123M56	RN_-43	25	32	170	17.53	25.40	RSN-43	CLP-310	N/A
RAR-2540M4	9T51224M56	RN_-43	25	40	250	17.53	25.40	RSN-43	CLP-312	N/A
RAL-2540M4	9T51124M56	RN_-43	25	40	250	17.53	25.40	RSN-43	CLP-312	N/A
RAR-2525M6	9T51225M72	RN_-64	25	25	150	24.13	25.40	RSN-63	CLP-58	N/A
RAL-2525M6	9T51125M72	RN_-64	25	25	150	24.13	25.40	RSN-63	CLP-58	N/A
RAR-2532M6	9T51223M72	RN_-64	25	32	170	24.13	25.40	RSN-63	CLP-510	N/A
RAL-2532M6	9T51123M72	RN_-64	25	32	170	24.13	25.40	RSN-63	CLP-510	N/A
RAR-4040M8	9T51240M83	RN_-86	40	40	250	30.48	38.10	RSN-84	CLP-612	N/A
RAL-4040M8	9T51140M83	RN_-86	40	40	250	30.48	38.10	RSN-84	CLP-612	N/A

SBL/R

15° Holder for 90° Square

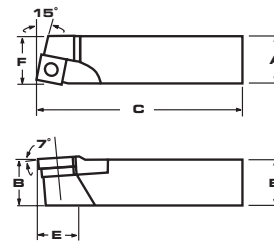

RH SHOWN

PARTS

Description	EDP Code	Insert	A	B	C	E	F	PARTS		
								Seat	Cam Pin	Seat Screw
SBR-2020M4	9T51720M56	SN_-43	20	20	125	22.10	16.00	SSN-432	CLP-36	N/A
SBL-2020M4	9T51620M56	SN_-43	20	20	125	22.10	16.00	SSN-432	CLP-36	N/A
SBR-2525M4	9T51725M56	SN_-43	25	25	150	22.10	19.81	SSN-432	CLP-38	N/A
SBL-2525M4	9T51625M56	SN_-43	25	25	150	22.10	19.81	SSN-432	CLP-38	N/A
SBR-3232M6	9T51732M72	SN_-64	32	32	170	31.75	26.16	SSN-632	CLP-510	N/A
SBL-3232M6	9T51632M72	SN_-64	32	32	170	31.75	26.16	SSN-632	CLP-510	N/A

TAL/R

30° Holder for 60° Triangle

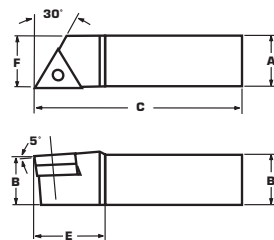

RH SHOWN

PARTS

Description	EDP Code	Insert	A	B	C	E	F	PARTS		
								Seat	Cam Pin	Seat Screw
TAR-1616M3	9T8521048	TN_-32	16	16	100	19.81	16.26	TSN-324	CLP-25	N/A
TAL-1616M3	9T8501048	TN_-32	16	16	100	19.81	16.26	TSN-324	CLP-25	N/A
TAR-2020M3	9T8521248	TN_-32	20	20	125	19.81	19.56	TSN-324	CLP-25	N/A
TAL-2020M3	9T8501248	TN_-32	20	20	125	19.81	19.56	TSN-324	CLP-25	N/A
TAR-2525M4	9T8521656	TN_-43	25	25	150	25.40	26.16	TSN-435	CLP-38	N/A
TAL-2525M4	9T8501656	TN_-43	25	25	150	25.40	26.16	TSN-435	CLP-38	N/A
TAR-2532M4	9T8524456	TN_-43	25	32	170	25.40	26.16	TSN-435	CLP-310	N/A
TAL-2532M4	9T8504456	TN_-43	25	32	170	25.40	26.16	TSN-435	CLP-310	N/A
TAR-2525M5	9T8521664	TN_-54	25	25	150	30.23	26.16	TSN-535	CLP-48	N/A
TAL-2525M5	9T8501664	TN_-54	25	25	150	30.23	26.16	TSN-535	CLP-48	N/A
TAR-3232M5	9T8522064	TN_-54	32	32	170	30.23	32.51	TSN-535	CLP-410	N/A
TAL-3232M5	9T8502064	TN_-54	32	32	170	30.23	32.51	TSN-535	CLP-410	N/A
TAR-2532M5	9T8524464	TN_-54	25	32	170	30.23	26.16	TSN-535	CLP-410	N/A
TAL-2532M5	9T8504464	TN_-54	25	32	170	30.23	26.16	TSN-535	CLP-410	N/A



TE 30° Holder for 60° Triangle

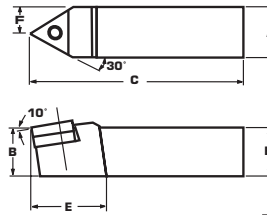

RH SHOWN

PARTS

Description	EDP Code	Insert	A	B	C	E	F	PARTS		
								Seat	Cam Pin	Seat Screw
TE-1616M3	9T86216M48	TN__-32	16	16	100	18.54	9.53	TSN-324	CLP-25	N/A
TE-2020M4	9T86220M48	TN__-43	20	20	125	25.91	9.53	TSN-434	CLP-36	N/A
TE-2525M4	9T86225M56	TN__-43	25	25	150	25.91	12.70	TSN-434	CLP-38	N/A
TE-3232M5	9T86232M64	TN__-54	32	32	170	29.21	15.88	TSN-534	CLP-410	N/A
TE-4040M6	9T86240M76	TN__-66	40	40	250	34.04	19.05	TSN-637	CLP-512T	N/A

TFL/R 30° Holder for 60° Triangle

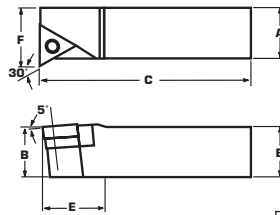

RH SHOWN

PARTS

Description	EDP Code	Insert	A	B	C	E	F	PARTS		
								Seat	Cam Pin	Seat Screw
TFR-2525M4	9T86825M56	TN__-43	25	25	150	25.40	31.50	TSN-434	CLP-38	N/A
TFL-2525M4	9T86625M56	TN__-43	25	25	150	25.40	31.50	TSN-434	CLP-38	N/A
TFR-3232M5	9T86832M64	TN__-54	32	32	170	30.23	37.34	TSN-534	CLP-410	N/A
TFL-3232M5	9T86632M64	TN__-54	32	32	170	30.23	37.34	TSN-534	CLP-410	N/A
TFR-4040M5	9T86840M64	TN__-54	40	40	250	30.23	43.69	TSN-537	CLP-412T	N/A
TFL-4040M5	9T86640M64	TN__-54	40	40	250	30.23	43.69	TSN-537	CLP-412T	N/A
TFR-4040M6	9T86840M76	TN__-66	40	40	250	N/A	43.94	TSN-636	CLP-512T	N/A
TFL-4040M6	9T86640M76	TN__-66	40	40	250	N/A	43.94	TSN-636	CLP-512T	N/A

TGL/R 30° Holder for 60° Triangle

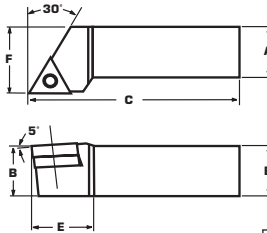

RH SHOWN

PARTS

Description	EDP Code	Insert	A	B	C	E	F	PARTS		
								Seat	Cam Pin	Seat Screw
TGR-2020M3	9T87420M48	TN__-32	20	20	100	22.86	25.91	TSN-324	CLP-25	N/A
TGL-2020M3	9T87220M48	TN__-32	20	20	100	22.86	25.91	TSN-324	CLP-25	N/A
TGR-2525M4	9T87425M56	TN__-43	25	25	150	28.96	32.51	TSN-435	CLP-38	N/A
TGL-2525M4	9T87225M56	TN__-43	25	25	150	28.96	32.51	TSN-435	CLP-38	N/A
TGR-2532M4	9T87423M56	TN__-43	25	32	150	28.96	32.51	TSN-435	CLP-310	N/A
TGL-2532M4	9T87223M56	TN__-43	25	32	150	28.96	32.51	TSN-435	CLP-310	N/A
TGR-2525M5	9T87425M64	TN__-54	25	25	150	33.27	32.51	TSN-535	CLP-48	N/A
TGL-2525M5	9T87225M64	TN__-54	25	25	150	33.27	32.51	TSN-535	CLP-48	N/A
TGR-3232M5	9T87432M64	TN__-54	32	32	170	33.27	38.86	TSN-535	CLP-410	N/A
TGL-3232M5	9T87232M64	TN__-54	32	32	170	33.27	38.86	TSN-535	CLP-410	N/A
TGR-4040M5	9T87440M64	TN__-54	40	40	250	33.27	45.21	TSN-535	CLP-412	N/A
TGL-4040M5	9T87240M64	TN__-54	40	40	250	33.27	45.21	TSN-535	CLP-412	N/A
TGR-4040M6	9T87440M76	TN__-66	40	40	250	37.59	45.47	TSN-636	CLP-512T	N/A
TGL-4040M6	9T87240M76	TN__-66	40	40	250	37.59	45.47	TSN-636	CLP-512T	N/A



SI-MCLNL/R 5° Bar for 80° Diamond

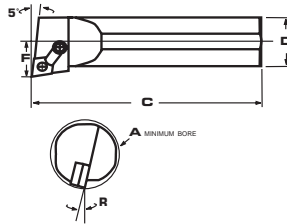

RH SHOWN

PARTS

Description	EDP Code	Insert	A	C	D	F	R	PARTS				
								Seat	Lock Pin	Clamp	Clamp Screw	Seat Screw
SI-MCLNR-25M4	9T67625M56	CN_-43	32.51	300	25	16.26	14°	N/A	NLM44	CLM20	STCM11	N/A
SI-MCLNL-25M4	9T67425M56	CN_-43	32.51	300	25	16.26	14°	N/A	NLM44	CLM20	STCM11	N/A
SI-MCLNR-32M4	9T67632M56	CN_-43	38.86	350	32	19.43	14°	N/A	NLM44	CLM20	STCM11	N/A
SI-MCLNL-32M4	9T67432M56	CN_-43	38.86	350	32	19.43	14°	N/A	NLM44	CLM20	STCM11	N/A
SI-MCLNR-40M4	9T67640M56	CN_-43	45.21	350	40	22.61	14°	ICSN-432	NLM46	CLM20	STCM11	S-46
SI-MCLNL-40M4	9T67440M56	CN_-43	45.21	350	40	22.61	14°	ICSN-432	NLM46	CLM20	STCM11	S-46
SI-MCLNR-44M4	9T67644M56	CN_-43	51.56	350	44	25.78	12°	ICSN-432	NLM46	CLM20	STCM11	S-46
SI-MCLNL-44M4	9T67444M56	CN_-43	51.56	350	44	25.78	12°	ICSN-432	NLM46	CLM20	STCM11	S-46
SI-MCLNR-50M5	9T67650M64	CN_-54	65.07	400	50	32.54	12°	ICSN-533	NLM58	CLM12	XNSC0825	S-58
SI-MCLNL-50M5	9T67450M64	CN_-54	65.07	400	50	32.54	12°	ICSN-533	NLM58	CLM12	XNSC0825	S-58
SI-MCLNR-50M6	9T67650M72	CN_-64	65.07	400	50	32.54	12°	ICSN-633	NLM68	CLM12	XNSC0825	S-68
SI-MCLNL-50M6	9T67450M72	CN_-64	65.07	400	50	32.54	12°	ICSN-633	NLM68	CLM12	XNSC0825	S-68
SI-MCLNR-60M6	9T67660M72	CN_-64	77.77	400	60	38.89	10°	ICSN-633	NLM68	CLM12	XNSC0825	S-68
SI-MCLNL-60M6	9T67460M72	CN_-64	77.77	400	60	38.89	10°	ICSN-633	NLM68	CLM12	XNSC0825	S-68

SI-MDJNL/R 3° Bar for 55° Diamond

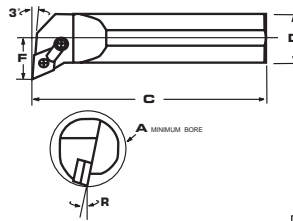

RH SHOWN

PARTS

Description	EDP Code	Insert	A	C	D	F	R	PARTS				
								Seat	Lock Pin	Clamp	Clamp Screw	Seat Screw
SI-MDJNR-32M4	9T68232M56	DN_-43	50.80	350	32	25.40	10°	IDSN-433	NLM46	CLM20	XNSC0825	S-46
SI-MDJNL-32M4	9T68032M56	DN_-43	50.80	350	32	25.40	10°	IDSN-433	NLM46	CLM20	XNSC0825	S-46
SI-MDJNR-40M4	9T68240M56	DN_-43	57.15	35	40	28.58	10°	IDSN-433	NLM46	CLM12	XNSC0825	S-46
SI-MDJNL-40M4	9T68040M56	DN_-43	57.15	350	40	28.58	10°	IDSN-433	NLM46	CLM12	XNSC0825	S-46
SI-MDJNR-50M4	9T68250M56	DN_-43	76.20	400	50	38.10	10°	IDSN-433	NLM46	CLM12	XNSC0825	S-46
SI-MDJNL-50M4	9T68050M56	DN_-43	76.20	400	50	38.10	10°	IDSN-433	NLM46	CLM12	XNSC0825	S-46
SI-MDJNR-50M5	9T68250M64	DN_-54	76.20	400	50	38.10	10°	IDSN-533	NLM58	CLM12	XNSC0825	S-58
SI-MDJNL-50M5	9T68050M64	DN_-54	76.20	400	50	38.10	10°	IDSN-533	NLM58	CLM12	XNSC0825	S-58

SI-MSKNL/R 15° Bar for 90° Square

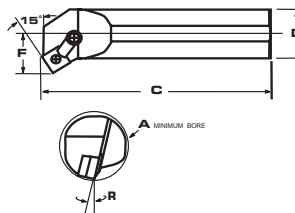

RH SHOWN

PARTS

Description	EDP Code	Insert	A	C	D	F	R	PARTS				
								Seat	Lock Pin	Clamp	Clamp Screw	Seat Screw
SI-MSKNR-32M4	9T70032M56	SN_-43	38.86	350	32	19.43	12°	N/A	NLM44	CLM9	XNSC0825	N/A
SI-MSKNL-32M4	9T69832M56	SN_-43	38.86	350	32	19.43	12°	N/A	NLM44	CLM9	XNSC0825	N/A
SI-MSKNR-40M4	9T70040M56	SN_-43	45.21	350	40	22.61	12°	ISSN-433	NLM46	CLM9	XNSC0825	S-46
SI-MSKNL-40M4	9T69840M56	SN_-43	45.21	350	40	22.61	12°	ISSN-433	NLM46	CLM9	XNSC0825	S-46
SI-MSKNR-44M4	9T70044M56	SN_-43	51.56	350	44	25.78	12°	ISSN-433	NLM46	CLM9	XNSC0825	S-46
SI-MSKNL-44M4	9T69844M56	SN_-43	51.56	350	44	25.78	12°	ISSN-433	NLM46	CLM9	XNSC0825	S-46
SI-MSKNR-50M5	9T70050M64	SN_-54	65.07	400	50	32.54	12°	ISSN-533	NLM58	CLM12	XNSC0825	S-58
SI-MSKNL-50M5	9T69850M64	SN_-54	65.07	400	50	32.54	12°	ISSN-533	NLM58	CLM12	XNSC0825	S-58
SI-MSKNR-60M5	9T70060M64	SN_-54	77.77	400	60	38.89	10°	ISSN-533	NLM58	CLM12	XNSC0825	S-58
SI-MSKNL-60M5	9T69860M64	SN_-54	77.77	400	60	38.89	10°	ISSN-533	NLM58	CLM12	XNSC0825	S-58
SI-MSKNR-70M5	9T70070M64	SN_-54	90.47	550	70	45.24	10°	ISSN-533	NLM58	CLM12	XNSC0825	S-58
SI-MSKNL-70M5	9T69870M64	SN_-54	90.47	550	70	45.24	10°	ISSN-533	NLM58	CLM12	XNSC0825	S-58

TURNING



TURNING

SI-MTFNL/R 90° Bar for 60° Triangle

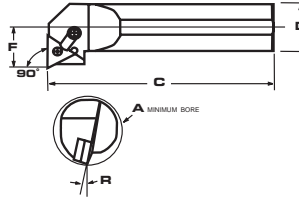

RH SHOWN

PARTS

Description	EDP Code	Insert	A	C	D	F	R	PARTS				
								Seat	Lock Pin	Clamp	Clamp Screw	Seat Screw
SI-MTFNR-25M3	9T7061649	TN_-33	32.51	300	25	16.26	12°	N/A	NLM33L	CLM9	XNSC0825	N/A
SI-MTFNL-25M3	9T7041649	TN_-33	32.51	300	25	16.26	12°	N/A	NLM33L	CLM9	XNSC0825	N/A
SI-MTFNR-32M3	9T7062049	TN_-33	38.86	350	32	19.43	12°	N/A	NLM33L	CLM9	XNSC0825	N/A
SI-MTFNL-32M3	9T7042049	TN_-33	38.86	350	32	19.43	12°	N/A	NLM33L	CLM9	XNSC0825	N/A
SI-MTFNR-40M4	9T7062456	TN_-43	52.37	350	40	26.19	10°	ITSN-433	NLM46	CLM9	XNSC0825	S-46
SI-MTFNL-40M4	9T7042456	TN_-43	52.37	350	40	26.19	10°	ITSN-433	NLM46	CLM9	XNSC0825	S-46
SI-MTFNR-44M4	9T7062856	TN_-43	58.72	350	44	29.36	10°	ITSN-433	NLM46	CLM9	XNSC0825	S-46
SI-MTFNL-44M4	9T7042856	TN_-43	58.72	350	44	29.36	10°	ITSN-433	NLM46	CLM9	XNSC0825	S-46
SI-MTFNR-50M4	9T7063256	TN_-43	65.07	400	50	32.54	8°	ITSN-433	NLM46	CLM9	XNSC0825	S-46
SI-MTFNL-50M4	9T7043256	TN_-43	65.07	400	50	32.54	8°	ITSN-433	NLM46	CLM9	XNSC0825	S-46
SI-MTFNR-70M4	9T7064056	TN_-43	77.77	400	70	38.89	8°	ITSN-433	NLM46	CLM9	XNSC0825	S-46
SI-MTFNL-70M4	9T7044056	TN_-43	77.77	400	70	38.89	8°	ITSN-433	NLM46	CLM9	XNSC0825	S-46

SI-MVJNL/R 3° Bar for 35° Diamond

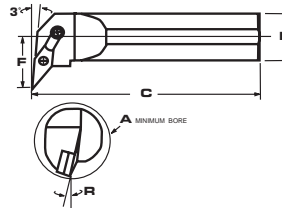

RH SHOWN

PARTS

Description	EDP Code	Insert	A	C	D	F	R	PARTS				
								Seat	Lock Pin	Clamp	Clamp Screw	Seat Screw
SI-MVJNR-32M3	9T71232M49	VN_-33	57.15	350	32	28.58	12°	IVSN-324	NLM34L	CL-30	XNSC0825	S-34
SI-MVJNL-32M3	9T71032M49	VN_-33	57.15	350	32	28.58	12°	IVSN-324	NLM34L	CL-30	XNSC0825	S-34
SI-MVJNR-40M3	9T71240M49	VN_-33	63.50	350	40	31.75	12°	IVSN-324	NLM34L	CL-30	XNSC0825	S-34
SI-MVJNL-40M3	9T71040M49	VN_-33	63.50	350	40	31.75	12°	IVSN-324	NLM34L	CL-30	XNSC0825	S-34
SI-MVJNR-44M4	9T71244M56	VN_-43	76.20	350	44	38.10	12°	IVSN-433	NLM46	CLM12	XNSC0825	S-46
SI-MVJNL-44M4	9T71044M56	VN_-43	76.20	350	44	38.10	12°	IVSN-433	NLM46	CLM12	XNSC0825	S-46
SI-MVJNR-50M4	9T71250M56	VN_-43	82.55	400	50	41.28	12°	IVSN-433	NLM46	CLM12	XNSC0825	S-46
SI-MVJNL-50M4	9T71050M56	VN_-43	82.55	400	50	41.28	12°	IVSN-433	NLM46	CLM12	XNSC0825	S-46
SI-MVJNR-70M4	9T71270M56	VN_-43	95.25	400	70	47.63	12°	IVSN-433	NLM46	CLM12	XNSC0825	S-46
SI-MVJNL-70M4	9T71070M56	VN_-43	95.25	400	70	47.63	12°	IVSN-433	NLM46	CLM12	XNSC0825	S-46

SI-MVLNL/R 5° Bar for 35° Diamond

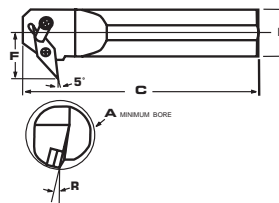

RH SHOWN

PARTS

Description	EDP Code	Insert	A	C	D	F	R	PARTS				
								Seat	Lock Pin	Clamp	Clamp Screw	Seat Screw
SI-MVLNR-40M3	9T7162449	VN_-33	57.15	350	40	28.58	12°	IVSN-324	NLM34L	CLM20	STCM11	S-34
SI-MVLNL-40M3	9T7142449	VN_-33	57.15	350	40	28.58	12°	IVSN-324	NLM34L	CLM20	STCM11	S-34
SI-MVLNR-44M3	9T7162849	VN_-33	63.50	350	44	34.93	12°	IVSN-324	NLM34L	CLM12	STCM11	S-34
SI-MVLNL-44M3	9T7142849	VN_-33	63.50	350	44	31.75	12°	IVSN-324	NLM34L	CLM12	STCM11	S-34
SI-MVLNR-50M4	9T7163256	VN_-43	76.20	400	50	34.93	12°	IVSN-433	NLM46	CLM12	XNSC0825	S-46
SI-MVLNL-50M4	9T7143256	VN_-43	76.20	400	50	38.10	12°	IVSN-433	NLM46	CLM12	XNSC0825	S-46
SI-MVLNR-60M4	9T7163656	VN_-43	82.55	400	60	38.10	12°	IVSN-433	NLM46	CLM12	XNSC0825	S-46
SI-MVLNL-60M4	9T7143656	VN_-43	82.55	400	60	38.10	12°	IVSN-433	NLM46	CLM12	XNSC0825	S-46



SI-MVPNL/R 27.5° Bar for 35° Diamond

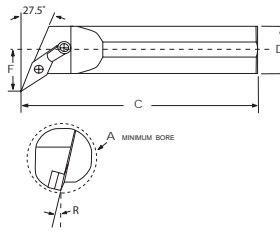

RH SHOWN

PARTS

Description	EDP Code	Insert	A	C	D	F	R	PARTS				
								Seat	Lock Pin	Clamp	Clamp Screw	Seat Screw
SI-MVPNR-32M3	9T72232M49	VN__-33	44.45	350	32	22.23	12°	IVSN-324	NLM34L	CL-30	XNSM0825	S-34
SI-MVPNL-32M3	9T72032M49	VN__-33	44.45	350	32	22.23	12°	IVSN-324	NLM34L	CL-30	XNSM0825	S-34
SI-MVPNR-50M3	9T72250M49	VN__-33	63.50	400	50	31.75	12°	IVSN-324	NLM34L	CL-30	XNSM0825	S-34
SI-MVPNL-50M3	9T72050M49	VN__-33	63.50	400	50	31.75	12°	IVSN-324	NLM34L	CL-30	XNSM0825	S-34

SI-MWLNL/R 5° Bar for 80° Trigon

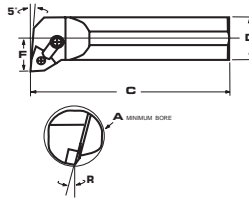

RH SHOWN

PARTS

Description	EDP Code	Insert	A	C	D	F	R	PARTS				
								Seat	Lock Pin	Clamp	Clamp Screw	Seat Screw
SI-MWLNR-20M3	9T73020M49	WN__-33	23.62	250	20	12.70	14°	N/A	NLM33L	CLM6	XNSN0515	N/A
SI-MWLNL-20M3	9T72820M49	WN__-33	23.62	250	20	12.70	14°	N/A	NLM33L	CLM6	XNSN0515	N/A
SI-MWLNR-25M3	9T73025M49	WN__-33	30.48	300	25	16.26	14°	N/A	NLM33L	CLM6	XNSN0515	N/A
SI-MWLNL-25M3	9T72825M49	WN__-33	30.48	300	25	16.26	14°	N/A	NLM33L	CLM6	XNSN0515	N/A
SI-MWLNR-32M3	9T73032M49	WN__-33	37.34	350	32	19.43	14°	IWSN-323	NLM34L	CLM6	XNSN0515	N/A
SI-MWLNL-32M3	9T72832M49	WN__-33	37.34	350	32	19.43	14°	IWSN-323	NLM34L	CLM6	XNSN0515	N/A
SI-MWLNR-25M4	9T73025M56	WN__-43	32.51	300	25	16.26	14°	N/A	NLM44	CLM20	STCM11	N/A
SI-MWLNL-25M4	9T72825M56	WN__-43	32.51	300	25	16.26	14°	N/A	NLM44	CLM20	STCM11	N/A
SI-MWLNR-32M4	9T73032M56	WN__-43	38.86	350	32	19.43	14°	IWSN-433	NLM46	CLM20	STCM11	N/A
SI-MWLNL-32M4	9T72832M56	WN__-43	38.86	350	32	19.43	14°	IWSN-433	NLM46	CLM20	STCM11	N/A

S_-SCFCL/R 90° Bar for 80° Diamond

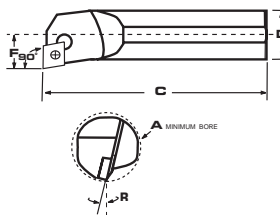

RH SHOWN

PARTS

EDP Code	Insert	A	C	D	F	R	Screw	PARTS	
								Insert	Description
S10M-SCFCR-2	9T5210M640	CC_-21.5	12.95	150	10	6.35	11°	TS25	
S10M-SCFCL-2	9T52310M40	CC_-21.5	12.95	150	10	6.35	11°	TS25	
S12M-SCFCR-3	9T52212M48	CC_-32.5	15.88	200	12	7.95	9°	TS42	
S12M-SCFCL-3	9T52312M48	CC_-32.5	15.88	200	12	7.95	9°	TS42	



TURNING

S_-SCLCL/R 5° Bar for 80° Diamond

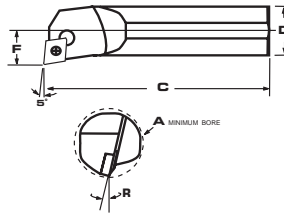

RH SHOWN

PARTS

Description	EDP Code	Insert	A	C	D	F	R	Insert Screw
S10M-SCLCR-2	9T53210M40	CC_-21.5	12.70	150	10	6.35	11°	TS25
S10M-SCLCL-2	9T53010M40	CC_-21.5	12.70	150	10	6.35	11°	TS25
S12M-SCLCR-2	9T53212M40	CC_-21.5	15.88	200	12	7.95	9°	TS25
S12M-SCLCL-2	9T53012M40	CC_-21.5	15.88	200	12	7.95	9°	TS25
S16M-SCLCR-2	9T53216M40	CC_-21.5	20.62	250	16	10.31	7°	TS25
S16M-SCLCL-2	9T53016M40	CC_-21.5	20.62	250	16	10.31	7°	TS25
S12M-SCLCR-3	9T53212M48	CC_-32.5	15.88	200	12	7.95	9°	TS42
S12M-SCLCL-3	9T53012M48	CC_-32.5	15.88	200	12	7.95	9°	TS42
S16M-SCLCR-3	9T53216M48	CC_-32.5	20.62	250	16	10.31	7°	TS42
S16M-SCLCL-3	9T53016M48	CC_-32.5	20.62	250	16	10.31	7°	TS42
S20M-SCLCR-3	9T53220M48	CC_-32.5	25.40	250	20	12.70	10°	TS42
S20M-SCLCL-3	9T53020M48	CC_-32.5	25.40	250	20	12.70	10°	TS42
S25M-SCLCR-3	9T53225M48	CC_-32.5	31.75	300	25	15.88	5°	TS42
S25M-SCLCL-3	9T53025M48	CC_-32.5	31.75	300	25	15.88	5°	TS42

S_-SDUCL/R 3° Bar for 55° Diamond

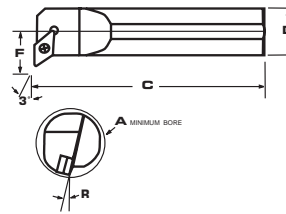

RH SHOWN

PARTS

Description	EDP Code	Insert	A	C	D	F	R	Insert Screw
S12M-SDUCR-2	9T53512M40	DC_-21.5	19.81	200	12	11.10	11°	TS25
S12M-SDUCL-2	9T53412M40	DC_-21.5	19.81	200	12	11.10	11°	TS25
S16M-SDUCR-2	9T53516M40	DC_-21.5	21.34	250	16	12.70	5°	TS25
S16M-SDUCL-2	9T53416M40	DC_-21.5	21.34	250	16	12.70	5°	TS25
S20M-SDUCR-3	9T53520M48	DC_-32.5	28.58	250	20	14.27	6°	TS42
S20M-SDUCL-3	9T53420M48	DC_-32.5	28.58	250	20	14.27	6°	TS42
S25M-SDUCR-3	9T53525M48	DC_-32.5	38.10	300	25	19.05	4°	TS42
S25M-SDUCL-3	9T53425M48	DC_-32.5	38.10	300	25	19.05	4°	TS42

S_-STFCL/R 90° Bar for 60° Triangle

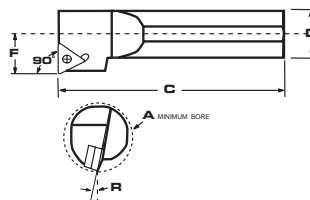

RH SHOWN

PARTS

Description	EDP Code	Insert	A	C	D	F	R	Insert Screw
S10M-STFCR-2	9T54010M40	TC_-21.5	12.70	150	10	6.35	11°	TS25
S10M-STFCL-2	9T53910M40	TC_-21.5	12.70	150	10	6.35	11°	TS25
S12M-STFCR-2	9T54012M40	TC_-21.5	15.88	200	12	7.95	9°	TS25
S12M-STFCL-2	9T53912M40	TC_-21.5	15.88	200	12	7.95	9°	TS25
S16M-STFCR-2	9T54016M40	TC_-21.5	20.62	250	16	10.31	7°	TS25
S16M-STFCL-2	9T53916M40	TC_-21.5	20.62	250	16	10.31	7°	TS25
S20M-STFCR-2	9T54020M40	TC_-21.5	25.40	250	20	12.70	6°	TS25
S20M-STFCL-2	9T53920M40	TC_-21.5	25.40	250	20	12.70	6°	TS25

TURNING



S₋-STUCL/R 3° Bar for 60° Triangle

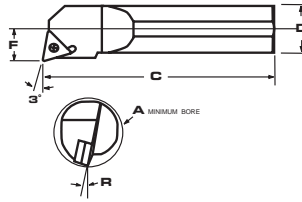

RH SHOWN

PARTS

Description	EDP Code	Insert	A	C	D	F	R	Insert Screw
S10M-STUCR-2	9T54310M40	TC_-21.5	12.70	150	10	6.35	11°	TS25
S10M-STUCL-2	9T54210M40	TC_-21.5	12.70	150	10	6.35	11°	TS25
S12M-STUCR-2	9T54312M40	TC_-21.5	15.88	200	12	7.95	9°	TS25
S12M-STUCL-2	9T54212M40	TC_-21.5	15.88	200	12	7.95	9°	TS25
S16M-STUCR-2	9T54316M40	TC_-21.5	20.62	250	16	10.31	7°	TS25
S16M-STUCL-2	9T54216M40	TC_-21.5	20.62	250	16	10.31	7°	TS25
S20M-STUCR-3	9T54320M48	TC_-32.5	25.40	250	20	12.70	6°	TS42
S20M-STUCL-3	9T54220M48	TC_-32.5	25.40	250	20	12.70	6°	TS42
S25M-STUCR-3	9T54325M48	TC_-32.5	32.51	300	25	16.26	4°	TS42
S25M-STUCL-3	9T54225M48	TC_-32.5	32.51	300	25	16.26	4°	TS42

S-4400W Steel Shank with Through Coolant

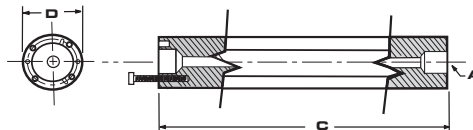

PARTS

Description	EDP Code	Head Style	D	C	A	Screw (4 req/d)
S-4425MW	9IBS4425MW	H25M-_____	25	228.60	1/4 - 18NPT	SSM61
S-4432MW	9IBS4432MW	H32M-_____	32	228.60	3/8 - 18NPT	SSM81
S-4440MW	9IBS4440MW	H40M-_____	40	254.00	3/8 - 18NPT	SSM85
S-4440MW	9IBS4440MW	H40M-_____	40	304.80	3/8 - 18NPT	SSM100
S-4450MW	9IBS4450MW	H50M-_____	50	330.20	3/8 - 18NPT	SSM100
S-4460MW	9IBS4460MW	H60M-_____	60	381.00	3/8 - 18NPT	SSM100
S-4470MW	9IBS4470MW	H70M-_____	70	431.80	3/8 - 18NPT	SSM83

S-4400W48 Steel Shank with Through Coolant

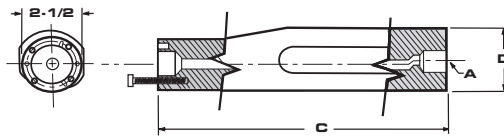

PARTS

Description	EDP Code	Head Style	D	C	A	Screw (4 req/d)
S-4480MW48	9IBS4480MW48	H80M-_____	80	457.2	3/8 - 18NPT	SSM89

TURNING

S-570 Steel Shank with Through Coolant

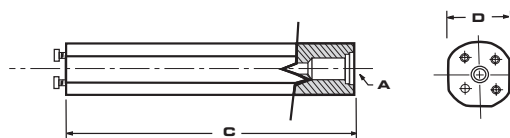

PARTS

Description	EDP Code	Head Style	D	C	A	Screw (4 req/d)
S-570-10-16M	9IBS5701016M	HS16-_____	16	106.93	1/8 - 27NPT	SSM62
S-570-12-20M	9IBS5701220M	HS20-_____	20	132.08	1/4 - 18NPT	SSM63
S-570-16-25M	9IBS5701625M	HS25-_____	25	182.88	1/4 - 18NPT	SSM64
S-570-20-32M	9IBS5702032M	HS32-_____	32	222.00	3/8 - 18NPT	SSM81
S-570-24-40M	9IBS5702440M	HS40-_____	40	273.05	1/2 - 14NPT	SSM100
S-570-32-50M	9IBS5703250M	HS50-_____	50	366.01	1/2 - 14NPT	SSM94
S-570-40-60M	9IBS5704060M	HS60-_____	60	468.12	1/2 - 14NPT	SSM95



H-MCLNL/R*

5° Head for 80° Diamond

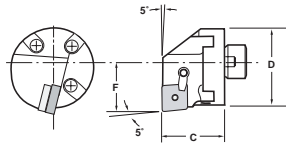

RH SHOWN

PARTS

Description	EDP Code	Insert	D	C	F	Min. Bore	PARTS				
							Seat	Lock Pin	Clamp	Clamp Screw	Seat Screw
H25M-MCLNR-4	9IHT67625M56	CN_-43	25	40	16.26	30.48	N/A	NLM44	CLM20	STCM11	N/A
H32M-MCLNR-4	9IHT67632M56	CN_-43	32	40	19.43	37.34	ICSN-433	NLM46	CLM20	STCM11	S-46
H40M-MCLNR-4	9IHT67640M56	CN_-43	40	40	22.61	44.70	ICSN-433	NLM46	CLM20	STCM11	S-46
H44M-MCLNR-4	9IHT67644M56	CN_-43	44	40	25.78	51.05	ICSN-433	NLM46	CLM20	STCM11	S-46
H50M-MCLNR-5	9IHT67650M64	CN_-54	50	40	32.54	60.96	ICSN-533	NLM58	CLM12	STCM11	S-58
H50M-MCLNR-6	9IHT67650M72	CN_-64	50	40	32.54	60.96	ICSN-633	NLM68	CLM12	STCM11	S-68
H70M-MCLNR-6	9IHT67670M72	CN_-64	70	40	38.89	76.96	ICSN-633	NLM68	CLM12	STCM11	S-68

*Left hand quoted on request.

HS-MCLNL/R*

5° Head for 80° Diamond (570 Type)

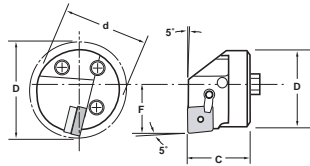

RH SHOWN

PARTS

Description	EDP Code	Insert	D	C	F	Min. Bore	PARTS				
							Seat	Lock Pin	Clamp	Clamp Screw	Seat Screw
HS32-MCLNR-4	9IHST28032M56	CN_-43	32	32	22	39.88	ICSN-433	NLM46	CLM20	STCM11	S-46
HS40-MCLNR-4	9IHST28040M56	CN_-43	40	32	27	50.04	ICSN-433	NLM46	CLM20	STCM11	S-46
HS50-MCLNR-5	9IHST28050M64	CN_-54	50	40	35	62.99	ICSN-533	NLM58	CLM12	STCM11	S-58
HS50-MCLNR-6	9IHST28050M72	CN_-64	50	40	35	62.99	ICSN-633	NLM68	CLM12	STCM11	S-68
HS60-MCLNR-6	9IHST28060M72	CN_-64	60	40	43	80.01	ICSN-633	NLM68	CLM12	STCM11	S-68

*Left hand quoted on request.

H-MDUNL/R*

3° Head for 55° Diamond

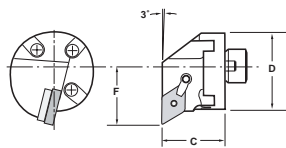

RH SHOWN

PARTS

Description	EDP Code	Insert	D	C	F	Min. Bore	PARTS				
							Seat	Lock Pin	Clamp	Clamp Screw	Seat Screw
H25M-MDUNR-3	9IHT6821648	DN_-33	25	40	19.05	33.02	N/A	NLM34L	CLM7	STCM11	N/A
H40M-MDUNR-3	9IHT6822448	DN_-33	40	40	28.58	50.80	IDSN-322	NLM34L	CLM7	STCM11	S-34
H50M-MDUNR-3	9IHT6823248	DN_-33	50	40	33.53	63.50	IDSN-322	NLM34L	CLM7	STCM11	S-34
H70M-MDUNR-3	9IHT6824048	DN_-33	70	40	44.45	82.55	IDSN-322	NLM34L	CLM7	STCM11	S-34
H32M-MDUNR-4	9IHT6822056	DN_-43	32	40	25.40	43.31	IDSN-443	NLM46L	CLM20	XNSM0825	S-46
H40M-MDUNR-4	9IHT6822456	DN_-43	40	40	28.58	50.80	IDSN-443	NLM46L	CLM12	XNSM0825	S-46
H44M-MDUNR-4	9IHT6822856	DN_-43	44	40	31.75	57.15	IDSN-443	NLM46L	CLM12	XNSM0825	S-46
H50M-MDUNR-4	9IHT6823256	DN_-43	50	40	34.80	63.50	IDSN-443	NLM46L	CLM12	XNSM0825	S-46
H60M-MDUNR-4	9IHT6823656	DN_-43	60	40	37.97	72.90	IDSN-443	NLM46L	CLM12	XNSM0825	S-46
H70M-MDUNR-4	9IHT6824056	DN_-43	70	40	44.45	82.55	IDSN-443	NLM46L	CLM12	XNSM0825	S-46

*Left hand quoted on request.



HS-MDUNL/R*

3° Head for 55° Diamond (570 Type)

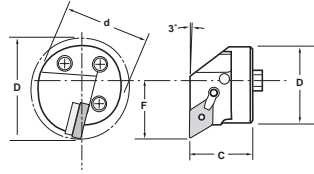

RH SHOWN

PARTS

Description	EDP Code	Insert	D	C	F	Min. Bore	PARTS				
							Seat	Lock Pin	Clamp	Clamp Screw	Seat Screw
HS40-MDUNR-4	9IHST68240M56	DN_-43	40	32	27	50.04	IDSN-433	NLM46	CLM12	XNSM0825	S-46
HS50-MDUNR-4	9IHST68250M56	DN_-43	50	40	35	62.99	IDSN-433	NLM46	CLM12	XNSM0825	S-46
HS60-MDUNR-4	9IHST68260M56	DN_-43	60	40	42.75	62.99	IDSN-433	NLM46	CLM12	XNSM0825	S-46

*Left hand quoted on request.

H-MSKNL/R*

15° Head for 90° Square

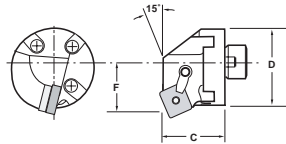

RH SHOWN

PARTS

Description	EDP Code	Insert	D	C	F	Min. Bore	PARTS				
							Seat	Lock Pin	Clamp	Clamp Screw	Seat Screw
H32M-MSKNR-4	9IHT70032M56	SN_-43	32	40	19.43	37.34	N/A	NLM44	CLM9	XNSM0825	N/A
H40M-MSKNR-4	9IHT70040M56	SN_-43	40	40	22.61	44.70	ISSN-433	NLM46	CLM9	XNSM0825	S-46
H40M-MSKNR-4	9IHT70040M56	SN_-43	40	40	25.78	51.05	ISSN-433	NLM46	CLM9	XNSM0825	S-46
H50M-MSKNR-4	9IHT70050M56	SN_-43	50	40	32.54	60.96	ISSN-433	NLM46	CLM9	XNSM0825	S-46
H60M-MSKNR-6	9IHT70060M64	SN_-64	60	40	41.28	76.96	ISSN-633	NLM68	CLM12	XNSM0825	S-68

*Left hand quoted on request.

HS-MSKNL/R*

15° Head for 90° Square (570 Type)

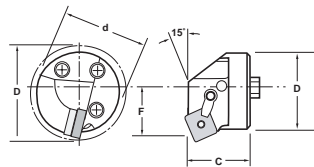

RH SHOWN

PARTS

Description	EDP Code	Insert	D	C	F	Min. Bore	PARTS				
							Seat	Lock Pin	Clamp	Clamp Screw	Seat Screw
HS32-MSKNR-4	9IHST70032M56	SN_-43	32	32	17	37.34	N/A	NLM44	CLM9	XNSM0825	N/A
HS40-MSKNR-4	9IHST70040M56	SN_-43	40	32	22	44.70	ISSN-433	NLM46	CLM9	XNSM0825	S-46
HS50-MSKNR-4	9IHST70050M56	SN_-43	50	40	27	60.96	ISSN-433	NLM46	CLM9	XNSM0825	S-46
HS60-MSKNR-6	9IHST70060M64	SN_-64	60	40	35	76.96	ISSN-633	NLM68	CLM12	XNSM0825	S-68

*Left hand quoted on request.

H-MTFNL/R*

90° Head for 60° Triangle

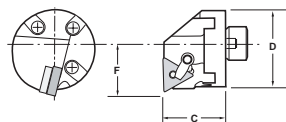

RH SHOWN

PARTS

Description	EDP Code	Insert	D	C	F	Min. Bore	PARTS				
							Seat	Lock Pin	Clamp	Clamp Screw	Seat Screw
H25M-MTFNR-3	9IHT70625M48	TN_-33	25	40	16.26	30.99	N/A	NLM33L	CLM7	STCM11	N/A
H40M-MTFNR-3	9IHT70640M48	TN_-33	40	40	22.61	44.70	ITSN-323	NLM34L	CLM7	STCM11	S-34
H44M-MTFNR-3	9IHT70644M48	TN_-33	44	40	25.78	51.05	ITSN-323	NLM34L	CLM7	STCM11	S-34
H50M-MTFNR-4	9IHT70650M56	TN_-43	50	40	32.54	60.96	ITSN-433	NLM46	CLM9	XNSM0825	S-46
H60M-MTFNR-4	9IHT70660M56	TN_-43	60	40	38.89	76.96	ITSN-433	NLM46	CLM9	XNSM0825	S-46

*Left hand quoted on request.



HS-MTFNL/R* 90° Head for 60° Triangle (570 Type)

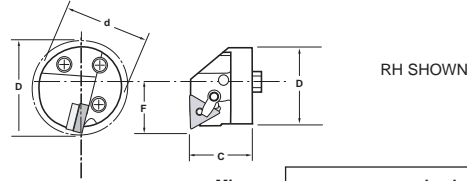

PARTS

Description	EDP Code	Insert	D	C	F	Min. Bore	Seat	Lock Pin	Clamp	Clamp Screw	Seat Screw
HS25-MTFNR-3	9IHST70625M48	TN_-33	25	32	22.00	39.88	N/A	NLM33L	CLM7	STCM11	N/A
HS40-MTFNR-3	9IHST70640M48	TN_-33	40	32	26.97	50.04	ITSN-323	NLM34L	CLM7	STCM11	S-34
HS50-MTFNR-4	9IHST70650M56	TN_-43	50	40	35.05	62.99	ITSN-433	NLM46	CLM9	XNSM0825	S-46
HS60-MTFNR-4	9IHST70660M56	TN_-43	60	40	43.00	80.01	ITSN-433	NLM46	CLM9	XNSM0825	S-46

*Left hand quoted on request.

H-MVUNL/R* 3° Head for 35° Diamond

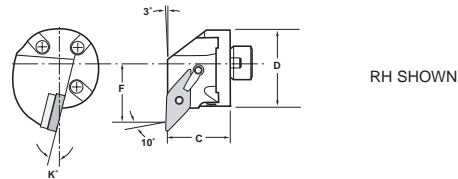

PARTS

Description	EDP Code	Insert	D	C	F	Min. Bore	Seat	Lock Pin	Clamp	Clamp Screw	Seat Screw
H25M-MVUNR-3	9IHT71225M49	VN_-33	25	40	25.40	43.31	IVSN-322	NLM34L	CL-30	XNSM0825	S-34
H40M-MVUNR-3	9IHT71240M49	VN_-33	40	40	28.58	50.80	IVSN-322	NLM34L	CL-30	XNSM0825	S-34
H50M-MVUNR-3	9IHT71250M49	VN_-33	50	40	34.93	63.50	IVSN-322	NLM34L	CL-30	XNSM0825	S-34
H60M-MVUNR-3	9IHT71260M49	VN_-43	60	40	44.45	82.55	IVSN-322	NLM34L	CL-30	XNSM0825	S-34
H50M-MVUNR-4	9IHT71250M56	VN_-43	50	40	34.93	63.50	IVSN-433	NLM46	CLM12	XNSM0825	S-46
H60M-MVUNR-4	9IHT71260M56	VN_-43	60	40	44.45	82.55	IVSN-433	NLM46	CLM12	XNSM0825	S-46

*Left hand quoted on request.

HS-MVUNL/R* 3° Head for 35° Diamond (570 Type)

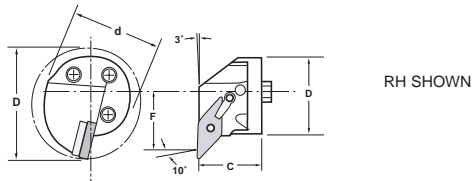

PARTS

Description	EDP Code	Insert	D	C	F	Min. Bore	Seat	Lock Pin	Clamp	Clamp Screw	Seat Screw
HS32-MVUNR-3	9IHST71232M49	VN_-33	32	32	25.40	43.31	IVSN-322	NLM34L	CL-30	XNSM0825	S-34
HS40-MVUNR-3	9IHST71240M49	VN_-33	40	32	28.58	50.80	IVSN-322	NLM34L	CL-30	XNSM0825	S-34
HS50-MVUNR-3	9IHST71250M49	VN_-33	50	40	34.93	82.55	IVSN-322	NLM34L	CL-30	XNSM0825	S-34
HS60-MVUNR-3	9IHST71260M49	VN_-33	60	40	44.45	63.50	IVSN-322	NLM34L	CL-30	XNSM0825	S-34
HS50-MVUNR-4	9IHST71250M56	VN_-43	50	40	34.93	82.55	IVSN-433	NLM46	CLM12	XNSM0825	S-46
HS60-MVUNR-4	9IHST71260M56	VN_-43	60	40	44.45	63.50	IVSN-433	NLM46	CLM12	XNSM0825	S-46

*Left hand quoted on request.

H-MWLNL/R* 5° Head for 80° Trigon

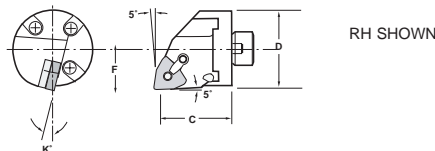

PARTS

Description	EDP Code	Insert	D	C	F	Min. Bore	Seat	Lock Pin	Clamp	Clamp Screw	Seat Screw
H25M-MWLNR-3	9IHT73025M49	WN_-33	25	40	16.26	30.48	IWSN-322	NLM33L	CLM6	XNSM0515	N/A
H32M-MWLNR-3	9IHT73032M49	WN_-33	32	40	19.43	37.34	IWSN-322	NLM34L	CLM6	XNSM0515	N/A
H40M-MWLNR-3	9IHT73040M49	WN_-33	40	40	22.61	44.70	IWSN-322	NLM34L	CLM6	XNSM0515	N/A
H50M-MWLNR-3	9IHT73050M49	WN_-33	50	40	32.54	60.96	IWSN-322	NLM34L	CLM6	XNSM0515	N/A
H32M-MWLNR-4	9IHT73032M56	WN_-43	32	40	19.43	37.34	IWSN-433	NLM46	CLM20	STCM11	N/A
H40M-MWLNR-4	9IHT73040M56	WN_-43	40	40	22.61	44.70	IWSN-433	NLM46	CLM20	STCM11	N/A
H44M-MWLNR-4	9IHT73044M56	WN_-43	44	40	25.78	51.05	IWSN-433	NLM46	CLM20	STCM11	N/A
H50M-MWLNR-4	9IHT73050M56	WN_-43	50	40	32.54	60.96	IWSN-433	NLM46	CLM20	STCM11	N/A

*Left hand quoted on request.



HS-MWLNL/R* 5° Head for 80° Trigon (570 Type)

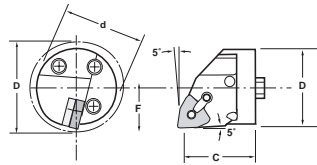

RH SHOWN

PARTS

Description	EDP Code	Insert	D	C	F	Min. Bore	PARTS				
							Seat	Lock Pin	Clamp	Clamp Screw	Seat Screw
HS25-MWLNR-3	9IHST73025M49	WN_-33	25	32	16.26	30.48	IWSN-322	NLM33L	CLM6	XNSM0515	N/A
HS32-MWLNR-3	9IHST73032M49	WN_-33	32	32	19.43	37.34	IWSN-322	NLM34L	CLM6	XNSM0515	N/A
HS40-MWLNR-3	9IHST73040M49	WN_-33	40	32	22.61	44.70	IWSN-322	NLM34L	CLM6	XNSM0515	N/A
HS50-MWLNR-3	9IHST73050M49	WN_-33	50	40	32.54	60.96	IWSN-322	NLM34L	CLM6	XNSM0515	N/A
HS32-MWLNR-4	9IHST73032M56	WN_-43	32	32	19.43	37.34	IWSN-433	NLM46	CLM20	STCM11	N/A
HS40-MWLNR-4	9IHST73040M56	WN_-43	40	32	22.61	44.70	IWSN-433	NLM46	CLM20	STCM11	N/A
HS50-MWLNR-4	9IHST73050M56	WN_-43	50	40	32.54	60.96	IWSN-433	NLM46	CLM20	STCM11	N/A

*Left hand quoted on request.



TURNING

Material		Chipbreaker	Depth of Cut	Feed Rate	
Low Carbon Steels BHN 100-225	STEEL	NEGATIVE ↑ FINISH ↓ ROUGH	FM	0.50 - 2.00	0.10 - 0.20
Carbon Steels BHN 200-300			MM	1.00 - 4.00	0.20 - 0.40
Alloy Steels BHN 225-275			RM	2.00 - 5.00	0.30 - 0.50
Alloy Steels BHN 275-400		POSITIVE ↑ FINISH ↓ ROUGH	HR	3.00 - 6.60	0.36 - 0.60
Alloy Steels BHN Over 400			FM	0.50 - 1.50	0.10 - 0.20
Tool Steels Hot & Cold Worked			MM	1.00 - 3.50	0.10 - 0.25
Martensitic Stainless Steel 400 Series		RM	1.00 - 4.00	0.20 - 0.36	
Austenitic Stainless Steel 300 Series	STAINLESS STEEL	NEGATIVE → FINISH ← ROUGH	FM	1.00 - 3.00	0.15 - 0.30
			MM	1.00 - 3.50	0.20 - 0.40
			RM	1.50 - 4.00	0.25 - 0.46
PH Duplex		POSITIVE → FINISH ← ROUGH	FM	0.50 - 2.00	0.05 - 0.15
			MM	0.50 - 3.00	0.05 - 0.20
			RM	1.00 - 3.50	0.10 - 0.25
Gray Iron	CAST IRON	NEGATIVE → FINISH ← ROUGH	FM	1.00 - 3.50	0.20 - 0.36
Ductile Iron BHN 140-180			RM	1.50 - 4.00	0.25 - 0.40
Ductile Iron BHN 190-250			FLAT TOP	1.00 - 5.00	0.20 - 0.50
Spheroidal Iron BHN 190-250	NON-FERROUS	NEG	FM	0.50 - 2.50	0.10 - 0.25
Aluminum > 5% Silicon			RM	1.50 - 3.50	0.25 - 0.40
Aluminum < 5% Silicon		POSITIVE ↑ FINISH ↓ ROUGH	FM	0.50 - 2.00	0.05 - 0.15
			MM	1.50 - 7.00	0.20 - 0.56
Copper / Zinc / Brass		RM	2.00 - 7.60	0.30 - 0.56	

TURNING



Cutting Data - Surface meters per minute

			AGS50		AGS54	
			F	R	F	R
STEEL	Free Machining Carbon Steels	m/min	500	250	250	150
		sfm	1600	640	800	480
	Plain Carbon Steels	m/min	400	200	180	50
		sfm	1280	640	576	160
	Alloy Steels 190-330 HB	m/min	300	140		
		sfm	960	400		
Alloy Steels 330-450 HB	m/min	180	120			
	sfm	576	384			

			APS35	
			F	R
STAINLESS STEEL	Martensitic 400 Series	m/min	165	80
		sfm	540	260
	300 Series	m/min	165	80
		sfm	540	260

			AS20	
			F	R
CAST IRON	Grey Cast 190-330 HB	m/min	500	250
		sfm	1600	640
	Grey Cast 330-450 HB	m/min	300	140
		sfm	876	448
	Alloy/Ductile	m/min	250	120
		sfm	800	384

			APS35	
			F	R
NON-FERROUS	Free Machining Aluminum	m/min	180	100
		sfm	540	260
	High Silicon Aluminum Alloys	m/min	95	50
		sfm	304	160
	Copper Zinc Brass	m/min	180	100
		sfm	576	330
	Non-Metallics	m/min	180	100
		sfm	576	330

			APS35	
			F	R
HIGH TEMP ALLOYS	High Temp Alloys 200-260 HB	m/min	200	60
		sfm	650	200
	High Temp Alloys 260-450 HB	m/min	65	35
		sfm	215	115
	Titanium Alloys (Ti 6Al-4V)	m/min	180	110
		sfm	525	345

NOTE: Decrease Vc if interrupted cut, roughing, unstable conditions and/or uncoated grade



VEE BOTTOM

VEE BOTTOM



ACME THREADING

V84/V85/V120

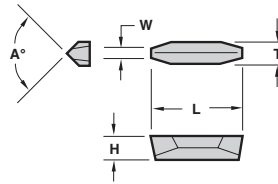

Description	EDP Code	TPI	W	T	L	H	A°	Coating					
								C3	GP3	GP5	AC3	AC50	
V84 NT 3P	0261030	3	3.01	6.35	25.40	6.35	90°		●	●	●		
V84 NT 4P	0261040	4	2.22	6.35	25.40	6.35	90°		●	●	●		
V84 NT 5P	0261050	5	1.75	6.35	25.40	6.35	90°		●	●	●		
V84 NT 6P	0261060	6	1.44	6.35	25.40	6.35	90°		●	●	●		
V84 NT 8P	0261080	8	1.04	6.35	25.40	6.35	90°		●	●	●		●
V84 NT 10P	0261100	10	0.81	6.35	25.40	6.35	90°		●	●	●		
V84 NT 12P	0261120	12	0.72	6.35	25.40	6.35	90°		●	●	●		
V85 NT 2P	0263020	2	4.58	7.92	25.40	6.35	90°		●	●	●		
V85 NT 3P	0263030	3	3.01	7.92	25.40	6.35	90°		●	●	●		
V120 NT 1P	0270010	1	9.28	19.05	38.10	9.53	120°			●			
V120 NT 1.5P	0270015	1.5	6.14	19.05	38.10	9.53	120°			●			

ACME STUB THREADING

V84/V85/V120

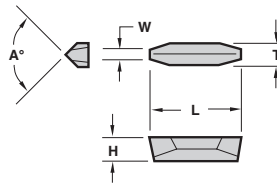

Description	EDP Code	TPI	W	T	L	H	A°	Coating					
								C3	GP3	GP5	AC3	AC50	
V84 NT 3P STUB	0261031	3	3.44	6.35	25.40	6.35	90°		●	●	●		
V84 NT 4P STUB	0261041	4	2.55	6.35	25.40	6.35	90°		●	●	●		
V84 NT 5P STUB	0261051	5	2.01	6.35	25.40	6.35	90°		●	●	●		
V84 NT 6P STUB	0261061	6	1.66	6.35	25.40	6.35	90°		●	●	●		
V84 NT 8P STUB	0261081	8	1.21	6.35	25.40	6.35	90°		●	●	●		
V84 NT 10P STUB	0261101	10	0.94	6.35	25.40	6.35	90°		●	●	●		
V84 NT 12P STUB	0261121	12	0.83	6.35	25.40	6.35	90°		●	●	●		
V85 NT 2P STUB	0263021	2	5.23	7.92	25.40	6.35	90°		●	●	●		
V120 NT 1P STUB	0270011	1	10.60	19.05	38.10	9.53	120°			●			

API BUTTRESS THREADING

V84

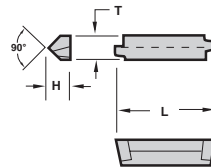

Description	EDP Code	TPI	TPF	T	L	H	Connection	Coating					
								C3	GP3	GP5	AC3	AC50	
V84 5B75 EXT-FC*	16614F	5	3/4	6.35	25.40	6.35	4-1/2 - 13-3/8				●		
V84 5B1 EXT-FC	17614F	5	1	6.35	25.40	6.35	16 and larger				●		
V84 8B75 EXT-FC	21614F	8	3/4	6.35	25.40	6.35	US Improved Buttress				●		
V84 5B75 INT-FC	16618F	5	3/4	6.35	25.40	6.35	4-1/2 - 13-3/8				●		
V84 5B1 INT-FC	17618F	5	1	6.35	25.40	6.35	16 and larger				●		
V84 8B75 INT-FC	21618F	8	3/4	6.35	25.40	6.35	US Improved Buttress				●		

*FC indicates 5° flank clearance

VEE BOTTOM

API HUGHES THREADING

V85/V96

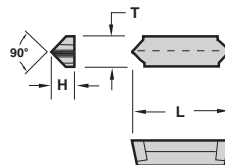

Description	EDP Code	TPI	TPF	T	L	H	Connection	Coating					
								C3	GP3	GP5	AC3	AC50	
V85 H902 EXT	28634	3-1/2	2	6.35	25.40	6.35	3-1/2 - 6-5/8 H90				●		
V85 H902 INT	28638	3-1/2	2	6.35	25.40	6.35	3-1/2 - 6-5/8 H90				●		
V85 H903 EXT	29634	3-1/2	3	6.35	25.40	6.35	7 - 8-5/8				●		
V85 H903 INT	29638	3-1/2	3	6.35	25.40	6.35	7 - 8-5/8				●		
V96 H90S EXT	27664	3	1-1/4	9.53	28.58	9.53	2-3/8 - 3-1/2 Slimline			●	●		
V96 H90S INT	27668	3	1-1/4	9.53	28.58	9.53	2-3/8 - 3-1/2 Slimline			●	●		

In an effort to improve our stock standard grade offering, there are periodic changes. Please see current price list for up to date grade offering.

- High performance choice in optimal conditions.
- ▲ Recommended grade under general conditions.

Material	GP3	GP5	AC3	AC50
Cast Iron	●			
Non-Ferrous	●			
Stainless/High Temp	●			
Steel		●	●	



VEE BOTTOM

API ROTARY SHOULDER THREADING V85

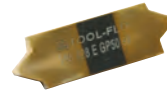
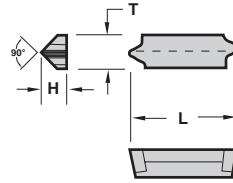

Description	EDP Code	TPI	TPF	T	L	H	Connection	Coating					
								C3	GP3	GP5	GP50	AC3	AC50
V85 425 EXT	09634	4	2	7.92	25.40	6.35	5-1/2 - 6-5/8 FH, 6-5/8 REG				●	●	●
V85 428 EXT	10634	4	2	7.92	25.40	6.35	NC23 - 50, 2-3/8 - 5-1/2 IF				●	●	●
V85 42F EXT*	14634	4	2	7.92	25.40	6.35	VO.065*				●	●	●
V85 435 EXT	11634	4	3	7.92	25.40	6.35	5-1/2 REG, 7-5/8 REG, 8-5/8 REG				●	●	●
V85 438 EXT	12634	4	3	7.92	25.40	6.35	NC56 - NC71				●	●	●
V85 530 EXT	13634	5	3	7.92	25.40	6.35	3-1/2FH, 2-3/8 - 4-1/2 REG				●	●	●
V85 4PAC EXT	15634	4	1-1/2	7.92	25.40	6.35	2-3/8 - 4-1/2 AMERICAN/PAC				●	●	●
V85 425 INT	09638	4	2	7.92	25.40	6.35	5-1/2 - 6-5/8 FH, 6-5/8 REG				●	●	●
V85 428 INT	10638	4	2	7.92	25.40	6.35	NC23 - 50, 2-3/8 - 5-1/2 IF				●	●	●
V85 42F INT*	14638	4	2	7.92	25.40	6.35	VO.065*				●	●	●
V85 435 INT	11638	4	3	7.92	25.40	6.35	5-1/2 REG, 7-5/8 REG, 8-5/8 REG				●	●	●
V85 438 INT	12638	4	3	7.92	25.40	6.35	NC56 - NC71				●	●	●
V85 530 INT	13638	5	3	7.92	25.40	6.35	3-1/2FH, 2-3/8 - 4-1/2 REG				●	●	●
V85 4PAC INT	15638	4	1-1/2	7.92	25.40	6.35	2-3/8 - 4-1/2 AMERICAN/PAC				●	●	●

* Obsolete thread form, See A.P.I. Spec 7, 35th Edition, May 1, 1995, Section 9.4

API ROUND THREADING V84

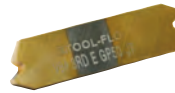
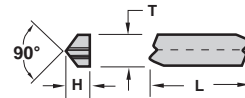

Description	EDP Code	TPI	TPF	T	L	H	Coating					
							C3	GP3	GP5	GP50	AC3	AC50
V84 10RD EXT	34614	10	3/4	6.35	25.40	6.35				●	●	●
V84 10RD INT	34618	10	3/4	6.35	25.40	6.35				●	●	●
V84 8RD EXT	32614	8	3/4	6.35	25.40	6.35				●	●	●
V84 8RD INT	32618	8	3/4	6.35	25.40	6.35				●	●	●

API VAM THREADING V84

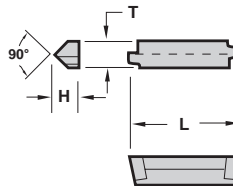

Description	EDP Code	TPI	TPF	T	L	H	Coating					
							C3	GP3	GP5	GP50	AC3	AC50
V84 5 VAM EXT	23614	5	3/4	6.35	25.40	6.35				●	●	●
V84 5 VAM INT	23618	5	3/4	6.35	25.40	6.35				●	●	●
V84 6 VAM EXT	24614	6	3/4	6.35	25.40	6.35				●	●	●
V84 6 VAM INT	24618	6	3/4	6.35	25.40	6.35				●	●	●
V84 8 VAM EXT	25614	8	3/4	6.35	25.40	6.35				●	●	●
V84 8 VAM INT	25618	8	3/4	6.35	25.40	6.35				●	●	●

API X-LINE THREADING V84

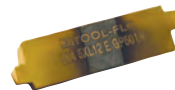
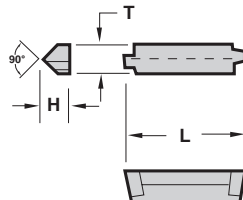

Description	EDP Code	TPI	TPF	T	L	H	Connection	Coating					
								C3	GP3	GP5	GP50	AC3	AC50
V84 5XL12 EXT	18614	5	1-1/4	6.35	25.40	6.35	8-5/8 - 10-3/4				●	●	●
V84 5XL12 INT	18618	5	1-1/4	6.35	25.40	6.35	8-5/8 - 10-3/4				●	●	●
V84 6XL15 EXT	19614	6	1-1/2	6.35	25.40	6.35	5 - 7-5/8				●	●	●
V84 6XL15 INT	19618	6	1-1/2	6.35	25.40	6.35	5 - 7-5/8				●	●	●
V84 6XL75 EXT	20614	6	3/4	6.35	25.40	6.35	-				●	●	●
V84 6XL75 INT	20618	6	3/4	6.35	25.40	6.35	-				●	●	●

In an effort to improve our stock standard grade offering, there are periodic changes. Please see current price list for up to date grade offering.

- High performance choice in optimal conditions.
- ▲ Recommended grade under general conditions.

Material	C3	GP3	GP5	GP50	AC3	AC50
Cast Iron					●	●
Non-Ferrous					●	●
Stainless/High Temp					●	●
Steel					●	●

VEE BOTTOM

VEE BOTTOM



DEEP GROOVING DBP (SAME AS VDB)

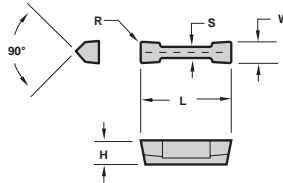

Description	EDP Code	W	R	L	H	S	Coatings						
							C3	GP3	GP5	GP50	AC3	AC50	
DBP 24 R15	802415	3.18	0.38	28.58	6.35	2.69		●					
DBP 24 R30	802430	3.18	0.76	28.58	6.35	2.69							
DBP 34 R15	803415	4.78	0.38	28.58	6.35	3.66		●					
DBP 34 R30	803430	4.78	0.76	28.58	6.35	3.66							
DBP 45 R15	804515	6.35	0.38	28.58	8.56	3.66		●					
DBP 45 R30	804530	6.35	0.76	28.58	8.56	3.66							
DBP 55 R15	805515	7.92	0.38	28.58	8.56	5.13		●					
DBP 55 R30	805530	7.92	0.76	28.58	8.56	5.13							
DBP 65 R15	806515	9.53	0.38	28.58	8.56	7.01		●					
DBP 65 R30	806530	9.53	0.76	28.58	8.56	7.01							

DEEP GROOVING DBP-CB (SAME AS VDB)

Features:

- Patented chipbreaker - Patent No. 6,146,064
- Maximum chip control
- Industry standard widths

Exclusive patented design!

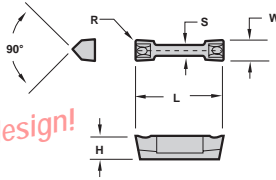

Description	EDP Code	W	R	L	H	S	Coatings						
							C3	GP3	GP5	GP50	AC3	AC50	
DBP 24 R15-CB	802415C	3.18	0.38	28.58	6.35	2.69		●					
DBP-34 R15-CB	803415C	4.78	0.38	28.58	6.35	3.66							
DBP 45 R15-CB	804515C	6.35	0.38	28.58	8.56	3.66		●					
DBP 45 R30-CB	804530C	6.35	0.76	28.58	8.56	3.66							
DBP 55 R15-CB	805515C	7.92	0.38	28.58	8.56	5.13		●					
DBP 55 R30-CB	805530C	7.92	0.76	28.58	8.56	5.13							

DEEP GROOVING DBP-Full Nose Radius (SAME AS VDB)

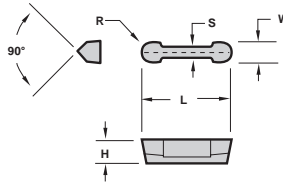

Description	EDP Code	W	R	L	H	S	Coatings						
							C3	GP3	GP5	GP50	AC3	AC50	
DBP 24 FNR	8024FR	3.18	1.59	28.58	6.35	2.69		●					
DBP 34 FNR	8034FR	4.78	2.39	28.58	6.35	3.66							
DBP 45 FNR	8045FR	6.35	3.18	28.58	8.56	3.66		●					
DBP 55 FNR	8055FR	7.92	3.96	28.58	8.56	5.13							
DBP 65 FNR	8065FR	9.53	4.76	28.58	8.56	7.01		●					

DEEP GROOVING GC

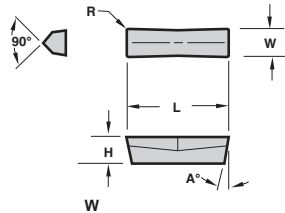

Description	EDP Code	Inch	Metric	R	L	H	A°	Coatings						
								C3	GP3	GP5	GP50	AC3	AC50	
GC-4125	GC4125	.125	3,18	0.25/0.38	25.40	4.78	4°		●					
GC-4187	GC4187	.187	4,75	0.25/0.38	25.40	8.33	5°							
GC-4250	GC4250	.250	6,35	0.25/0.38	25.40	8.33	5°		●					
GC-4312	GC4312	.312	7,92	0.25/0.38	25.40	8.33	5°							
GC-4375	GC4375	.375	9,52	0.25/0.38	25.40	8.33	5°							
GC-6187	GC6187	.187	4,75	0.25/0.38	38.10	8.33	5°		●					
GC-6250	GC6250	.250	6,35	0.25/0.38	38.10	8.33	5°							
GC-6312	GC6312	.312	7,92	0.25/0.38	38.10	8.33	5°		●					

In an effort to improve our stock standard grade offering, there are periodic changes. Please see current price list for up to date grade offering.

● High performance choice in optimal conditions.
▲ Recommended grade under general conditions.

Material	GP3	GP5	GP50	AC3	AC50
Cast Iron	▲			●	
Non-Ferrous	▲			●	
Stainless/High Temp	▲			●	
Steel			▲		●



VEE BOTTOM

DEEP GROOVING GR - Full Nose Radius

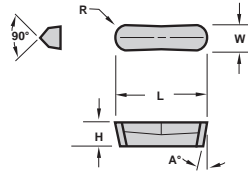

Description	EDP Code	Inch	Metric	R	L	H	A°	Coatings										
								Uncoated	TIN Coated	ATTN Coated	C3	GP3	GP5	GP50	AC3	AC50		
GR-4125	GR4125	.125	3,18	1.57	25.40	4.78	4°											
GR-4187	GR4187	.187	4,75	2.39	25.40	8.33	5°											
GR-4250	GR4250	.250	6,35	3.18	25.40	8.33	5°											

DEEP GROOVING VDB (SAME AS DBP)

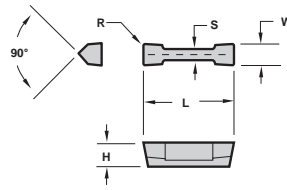

Description	EDP Code	Inch	Metric	R	L	H	S	Coatings										
								Uncoated	TIN Coated	ATTN Coated	C25	GP25	GP3	GP50	AC3	AC50		
VDB 125 A008	79125A08	.125	3,18	0.20	28.58	6.35	2.69											
VDB 125 A015	79125A	.125	3,18	0.38	28.58	6.35	2.69	●										
VDB 156 A008	79156A08	.156	3,96	0.20	28.58	6.35	2.69											
VDB 156 A015	79156A	.156	3,96	0.38	28.58	6.35	2.69											
VDB 188 A008	79188A08	.188	4,78	0.20	28.58	6.35	3.66	●	●									
VDB 188 A015	79188A	.188	4,78	0.38	28.58	6.35	3.66	●										
VDB 188 A030	79188A030	.188	4,78	0.76	28.58	6.35	3.66											
VDB 218-A015	79218A	.218	5,54	0.38	28.58	6.35	3.66											
VDB 250 A015	79250A	.250	6,35	0.38	28.58	6.35	3.66	●										
VDB 250 B015	79250B	.250	6,35	0.38	28.58	8.56	3.66											
VDB 250 B030	79250B030	.250	6,35	0.76	28.58	8.56	3.66											
VDB 281 B015	79281B	.281	7,14	0.38	28.58	8.56	5.13											
VDB 312 B015	79312B	.312	7,92	0.38	28.58	8.56	5.13											
VDB 312 B030	79312B030	.312	7,92	0.76	28.58	8.56	5.13											
VDB 344 B015	79344B	.344	8,74	0.38	28.58	8.56	7.01											
VDB 344 B030	79344B030	.344	8,74	0.76	28.58	8.56	7.01											
VDB 375 B015	79375B	.375	9,53	0.38	28.58	8.56	7.01											
VDB 375 B030	79375B030	.375	9,53	0.76	28.58	8.56	7.01											

DEEP GROOVING VDB-CB (SAME AS DBP)

Features:

- Patented chipbreaker - Patent No. 6,146,064
- Maximum chip control
- Industry standard widths

Exclusive patented design!

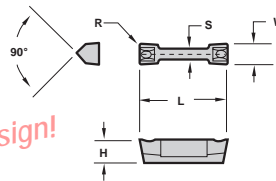

Description	EDP Code	Inch	Metric	R	L	H	S	Coatings										
								Uncoated	TIN Coated	ATTN Coated	C25	GP3	GP5	GP50	AC3	AC50		
VDB 125 A008-CB	79125A08P	.125	3,18	0.20	28.58	6.35	2.69											
VDB 125 A015-CB	79125AP	.125	3,18	0.38	28.58	6.35	2.69	●	●									
VDB 156 A008-CB	79156A08P	.156	3,96	0.20	28.58	6.35	2.69											
VDB 156 A015-CB	79156AP	.156	3,96	0.38	28.58	6.35	2.69											
VDB 188 A008-CB	79188A08P	.188	4,78	0.20	28.58	6.35	3.66	●	●									
VDB 188 A015-CB	79188AP	.188	4,78	0.38	28.58	6.35	3.66	●										
VDB 188 A030-CB	79188A030P	.188	4,78	0.76	28.58	6.35	3.66											
VDB 218 A015-CB	79218AP	.218	5,54	0.38	28.58	6.35	3.66											
VDB 250 B015-CB	79250BP	.250	6,35	0.38	28.58	8.56	3.66	●	●									
VDB 250 B030-CB	79250B030P	.250	6,35	0.76	28.58	8.56	3.66											
VDB 312 B015-CB	79312BP	.312	7,92	0.38	28.58	8.56	5.13											
VDB 312 B030-CB	79312B030P	.312	7,92	0.76	28.58	8.56	5.13											
VDB 375 B015-CB	79375BP	.375	9,53	0.38	28.58	8.56	7.01											
VDB 375 B030-CB	79375B030P	.375	9,53	0.76	28.58	8.56	7.01											

In an effort to improve our stock standard grade offering, there are periodic changes. Please see current price list for up to date grade offering.

- High performance choice in optimal conditions.
- ▲ Recommended grade under general conditions.

Material	Uncoated	TIN Coated	ATTN Coated
Cast Iron		▲	●
Non-Ferrous		▲	●
Stainless/High Temp		▲	●
Steel		▲	●

VEE BOTTOM

VEE BOTTOM



DEEP GROOVING

VDB - Full Nose Radius (SAME AS DBP)

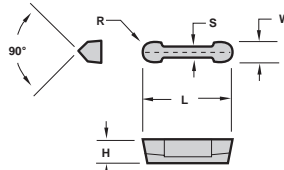

Description	EDP Code	Inch	Metric	R	L	H	S	Coatings						
								C25	GP3	GP5	GP50	AC3	AC50	
VDB 125 RA	79125RA	.125	3,18	1.57	28.58	6.35	2.69	●	●					
VDB 156 RA	79156RA	.156	3,96	1.98	28.58	6.35	2.69	●	●					
VDB 188 RA	79188RA	.188	4,78	2.39	28.58	6.35	3.66	●	●					
VDB 218 RA	79218RA	.218	5,54	2.77	28.58	6.35	3.66	●	●					
VDB 250 RA	79250RA	.250	6,35	3.18	28.58	6.35	3.66	●	●					
VDB 250 RB	79250RB	.250	6,35	3.18	28.58	8.56	3.66	●	●					
VDB 281 RB	79281RB	.281	7,14	3.56	28.58	8.56	5.13	●	●					
VDB 312 RB	79312RB	.312	7,92	3.96	28.58	8.56	5.13	●	●					
VDB 344 RB	79344RB	.344	8,74	4.37	28.58	8.56	7.01	●	●					
VDB 375 RB	79375RB	.375	9,53	4.75	28.58	8.56	7.01	●	●					

GROOVING

V84/V85/V96/V98/V120

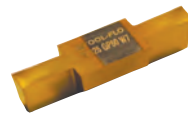
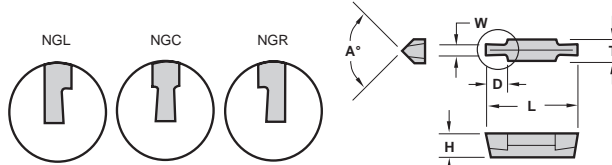

Description	EDP Code	Inch	Metric	D	T	L	H	A°	Coatings					
									C3	GP3	GP5	GP50	AC3	AC50
V84 NGC W.062	C6106200	.062	1,57	3.96	6.35	25.40	6.35	90°				●		
V84 NGC W.094	C6109400	.094	2,39	6.35	6.35	25.40	6.35	90°				●		
V84 NGC W.125	C6112500	.125	3,18	6.35	6.35	25.40	6.35	90°	●					●
V84 NGC W.187	C6118700	.187	4,75	6.35	6.35	25.40	6.35	90°	●					●
V84 NGC W.250	C6125000	.250	6,35	6.35	6.35	25.40	6.35	90°	●					●
V84 NGL W.125	L6112500	.125	3,18	6.35	6.35	25.40	6.35	90°				●		
V84 NGL W.187	L6118700	.187	4,75	6.35	6.35	25.40	6.35	90°				●		
V84 NGR W.125	R6112500	.125	3,18	6.35	6.35	25.40	6.35	90°				●		
V84 NGR W.187	R6118700	.187	4,75	6.35	6.35	25.40	6.35	90°				●		
V85 NGC W.312	C6331200	.312	7,92	8.26	7.92	25.40	6.35	90°		●	●			
V96 NGC W.375	C6637500	.375	9,53	11.43	9.53	28.58	9.53	90°						
V98 NGC W.500	C6850000	.500	12,70	11.43	12.70	28.58	9.53	90°		●				
V120 NGC W.625	C7625000	.625	15,88	15.88	19.05	38.10	9.53	120°						
V120 NGC W.750	C7075000	.750	19,05	15.88	19.05	38.10	9.53	120°		●				

NPT THREADING

V84

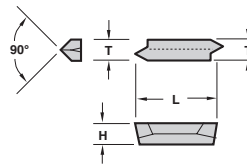

Description	EDP Code	Pipe Size	TPI	TPF	T	L	H	Coatings						
								C3	GP3	GP5	GP50	AC3	AC50	
V84 8NPT EXT	3661084	2-1/2" - up	8	3/4	6.35	25.40	6.35				●			
V84 8NPT INT	3661088	2-1/2" - up	8	3/4	6.35	25.40	6.35				●			
V84 11.5NPT EXT	3661114	1" - 2"	11.5	3/4	6.35	25.40	6.35				●			
V84 11.5NPT INT	3661118	1" - 2"	11.5	3/4	6.35	25.40	6.35				●			
V84 14NPT EXT	3661144	1/2" - 3/4"	14	3/4	6.35	25.40	6.35				●			
V84 14NPT INT	3661148	1/2" - 3/4"	14	3/4	6.35	25.40	6.35				●			

60° V-THREADING

V84/V85

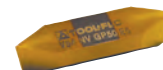
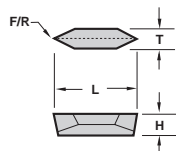

Description	EDP Code	TPI	F	T	L	H	Coatings							
							C25	GP3	GP5	GP50	AC3	AC50		
V84 NV	0161000	5-20	0.15/0.20	6.35	25.40	6.35	●	●						
V84 NV .010R	0161R10	4-20	0.25R	6.35	25.40	6.35		●						
V84 NV .020R	0161R20	4-12	0.51R	6.35	25.40	6.35		●						
V84 NV .025R	0161R25	4-8	0.64R	6.35	25.40	6.35		●						
V84 NV .038R	0161R38	4-6	0.97R	6.35	25.40	6.35		●						
V85 NV	0163000	5-20	0.15/0.20	7.92	25.40	6.35		●						●

In an effort to improve our stock standard grade offering, there are periodic changes. Please see current price list for up to date grade offering.

- High performance choice in optimal conditions.
- ▲ Recommended grade under general conditions.

Cast Iron	●					
Non-Ferrous	●					
Stainless/High Temp	●					
Steel		▲	▲		●	



VEE BOTTOM

EXTERNAL 90° HOLDER

CDHOR/L

■ RH Holders use LH components - See below.
All components sold separately.

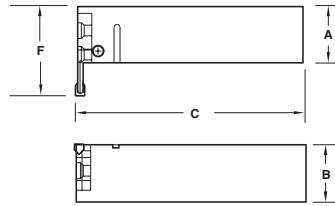

PARTS

Description	EDP Code	A	B	C	F*		Clamp Screw	Stop Screw	Anvil Screw
					.312(1)	.812(1)			
CDHOR-25M	921025M00	25.00	25.00	150.00	33.32	46.02	SBM90	SSM20	SFM95
CDHOL-25M	920025M00	25.00	25.00	150.00	33.32	46.02	SBM90	SSM20	SFM95
CDHOR-32M	921032M00	32.00	32.00	150.00	39.67	52.37	SBM90	SSM20	SFM95
CDHOL-32M	920032M00	32.00	32.00	150.00	39.67	52.37	SBM90	SSM20	SFM95
CDHOR-40M	921040M00	40.00	40.00	150.00	46.02	58.72	SBM90	SSM20	SFM95
CDHOL-40M	920040M00	40.00	40.00	150.00	46.02	58.72	SBM90	SSM20	SFM95

*The "F" dimension is determined by the D.O.C. of the anvil. (1) Anvil D.O.C.

EXTERNAL STRAIGHT HOLDER

CDVOR/L

■ RH Holders use RH components - See below.
All components sold separately.

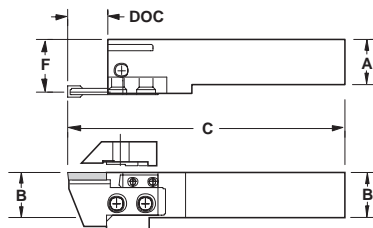

PARTS

Description	EDP Code	A	B	C	F	Clamp Screw	Stop Screw	Anvil Screw
CDVOL-25M	923025M00	25.00	25.00	*	29.21	SBM90	SSM20	SFM95
CDVOR-32M	924032M00	32.00	32.00	*	35.56	SBM90	SSM20	SFM95
CDVOL-32M	923032M00	32.00	32.00	*	35.56	SBM90	SSM20	SFM95
CDVOR-40M	924040M00	40.00	40.00	*	41.91	SBM90	SSM20	SFM95
CDVOL-40M	923040M00	40.00	40.00	*	41.91	SBM90	SSM20	SFM95

*The "C" dimension is determined by the D.O.C. of the anvil. If the D.O.C. is .312, C=5.500. If the D.O.C. is .812, C=6.000.

COMPONENTS

For CDHOR/L and CDVOR/L

All components sold separately.

ANVIL

CLAMP

STOP BLOCK

■ For face grooving anvils - See page 81.

Anvil	EDP Code	Insert	DOC	WOC	Clamp	Stop Block
AHR-118	9140118	VDB125	20.62	2.67-3.18	CHR-182	SBH-2
AHL-118	9130118	VDB125	20.62	2.67-3.18	CHL-182	SBH-2
AHR-148	9140148	V84/V85	20.62	5.59-6.35	CHR-482	SBH-2
AHL-148	9130148	V84/V85	20.62	5.59-6.35	CHL-482	SBH-2
AHR-173	9140173	V84/V85	20.62	V-THREAD	CHR-431	SBH-1
AHL-173	9130173	V84/V85	20.62	V-THREAD	CHL-431	SBH-1
AHR-113	9140113	DBP24/VDB125	7.92	2.67-3.18	CHR-132	SBH-4
AHL-113	9130113	DBP24/VDB125	7.92	2.67-3.18	CHL-132	SBH-4
AHR-138	9140138	DBP34/VDB188	20.62	4.32-4.78	CHR-382	SBH-2
AHL-138	9130138	DBP34/VDB188	20.62	4.32-4.78	CHL-382	SBH-2
AHR-148	9140148	VDB250A	20.62	5.59-6.35	CHR-482	SBH-2
AHL-148	9130148	VDB250A	20.62	5.59-6.35	CHL-482	SBH-2
AHR-248	9140248	DBP45/VDB250B	20.62	6.35-7.93	CHR-482	SBH-2
AHL-248	9130248	DBP45/VDB250B	20.62	6.35-7.93	CHL-482	SBH-2
AHR-268	9140268	DBP65/VDB375	20.62	8.89-9.53	CHR-582	SBH-2
AHL-268	9130268	DBP65/VDB375	20.62	8.89-9.53	CHL-582	SBH-2

VEE BOTTOM

VEE BOTTOM



EXTERNAL STRAIGHT HOLDER

CDVOR/L/C

One piece design

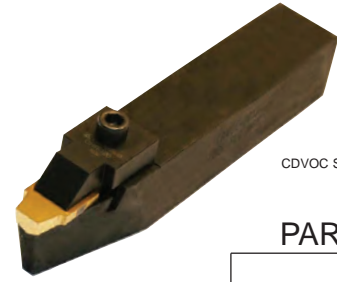
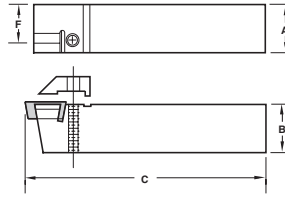

CDVOC Shown

PARTS

Description	EDP Code	Insert	A	B	C	F	PARTS	
							Clamp	Clamp Screw
CDVOR-25M8	92412582	V84/V85	25	25	150	21.8	CHR-431	SBM90
CDVOL-25M8	92312582	V84/V85	25	25	150	21.8	CHL-431	SBM90
CDVOR-32M8	92413282	V84/V85	32	32	150	28.8	CHR-431	SBM90
CDVOL-32M8	92313282	V84/V85	32	32	150	28.8	CHL-431	SBM90
CDVOR-32M9	92413286	V96/V98	32	32	180	25.5	CHR-98	SSM100
CDVOC-32M12	92413290	V120	32	32	180	22.5	CHR-120	SSM90

INTERNAL BAR

SI-CDHOR

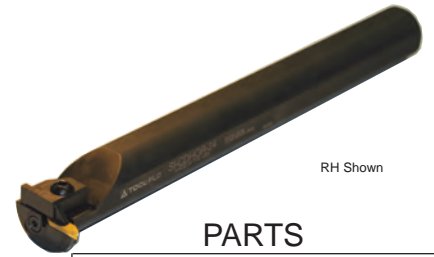
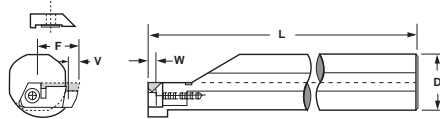

RH Shown

■ RH Bars use LH components

PARTS

Description	EDP Code	Insert	D	L	W	V	F	Min. Bore	D.O.C. at Min. Bore	PARTS			
										Anvil	Anvil Screw	Clamp	Clamp Screw
SI-CDHOR-40MM	96814000	V84	40	360	5.5-6.5	4.5	28.9	48.0	2.0	ABL/R-131	SFM69	CBL/R-411	SBM90
		V84			60°V	4.5	28.9	48.0	2.0	ABL/R-171	SFM69	CBL/R-411	SBM90
		V85			7.5-8.0	7.9	28.9	48.0	2.0	ABL/R-143	SFM69	CBL/R-531	SBM90
		DBP24/VDB125			2.6-3.2	7.9	28.9	53.5	6.0	ABL/R-113	SFM69	CBL.R-132	SBM90
		DBP34/VDB188			4.3-4.8	13.6	34.3	53.5	6.0	ABL/R-135	SFM69	CBL/R-352	SBM90
		VDB250A			5.5-6.5	13.6	34.3	53.5	6.0	ABL/R-145	SFM69	CBL/R-452	SBM90
		DBP45/VDB250B	5.5-6.5	13.6	34.3	53.5	6.0	ABL/R-245	SFM69	CBL/R-452	SBM90		

INTERNAL BAR

SI-CDHOR

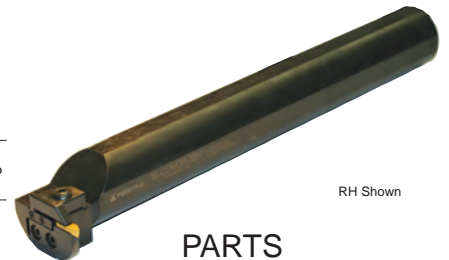
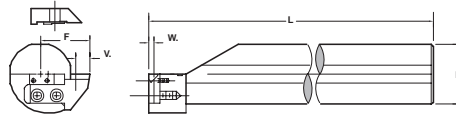

RH Shown

■ RH Bars use LH components

PARTS

Description	EDP Code	Insert	D	L	W	V	F	Min. Bore	D.O.C. at Min. Bore	PARTS					
										Anvil	Anvil Screw	Clamp	Clamp Screw	Stop Block	SBH Screw
SI-CDHOR-50MM	96815000	V84/V85	50	400	5.5-6.5	7.9	39.5	76.2	2.0	AHL/R-148	SFM95	CHL/R-482	SBM90	SBH-1	SSM20
		V84/V85			60°V	7.9	39.5	76.2	2.0	AHL/R-173	SFM95	CHL/R-431	SBM90	SBH-1	SSM20
		DBP34/VDB188			4.3-4.8	20.6	40.0	76.2	6.0	AHL/R-138	SFM95	CHL/R-382	SBM90	SBH-2	SSM20
		VDB250A			5.5-6.5	20.6	40.0	76.2	6.0	AHL/R-148	SFM95	CHL/R-482	SBM90	SBH-2	SSM20
					5.5-6.5	20.6	40.0	76.2	6.0	AHL/R-248	SFM95	CHL/R-482	SBM90	SBH-2	SSM20
						DBP45/VDB250B	5.5-6.5	20.6	40.0	76.2	6.0	AHL/R-248	SFM95	CHL/R-482	SBM90

INTERNAL BAR

SI-CDHOR/L

One piece design

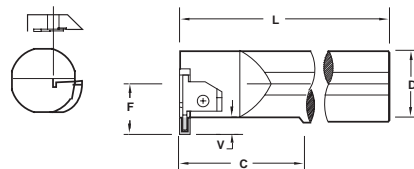

RH Shown

PARTS

Description	EDP Code	Insert	Min. Bore	D	L	C	F	V	D.O.C. at Min. Bore	PARTS	
										Clamp Screw	Clamp
SI-CDHOR-25M8	96812582	V84/V85	30.2	25	250	76.2	17.4	6.4	4.8	SM526	CBLM-84
SI-CDHOL-25M8	96712582	V84/V85	30.2	25	250	76.2	17.4	6.4	4.8	SM526	CBRM-84
SI-CDHOR-32M8	96813282	V84/V85	38.1	32	300	-	18.5	6.4	4.8	SM526	CBLM-84
SI-CDHOL-32M8	96713282	V84/V85	38.1	32	300	-	18.5	6.4	4.8	SM526	CBRM-84
SI-CDHOR-50M9	96815086	V96/V98	63.5	50	400	-	38.8	9.2	7.9	SSM110	CBL-98
SI-CDHOL-50M9	96715086	V96/V98	63.5	50	400	-	38.8	9.2	7.9	SSM110	CBR-98
SI-CDHOR-65M9	96816586	V96/V98	76.2	65	400	-	40.0	9.2	9.5	SSM110	CBL-98
SI-CDHOR-65M12	96816590	V120	76.2	65	400	204.7	40.0	14.0	12.7	SBM100	CBL-120



VEE BOTTOM

ACME THREADING MLPE

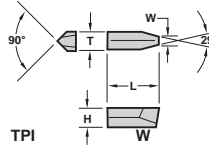

Description	EDP Code	TPI	W	T	L	H	Coating	
							TIN Coated	AlTiN Coated
MLPE 2532 NT 4P	0271040	4	2.22	4.78	12.70	3.81	●	●
MLPE 3425 NT 4P	0273040	4	2.22	6.35	15.88	4.78	●	●
MLPE 2532 NT 5P	0271050	5	1.75	4.78	12.70	3.81	●	●
MLPE 3425 NT 5P	0273050	5	1.75	6.35	15.88	4.78	●	●
MLPE 2532 NT 6P	0271060	6	1.44	4.78	12.70	3.81	●	●
MLPE 3425 NT 6P	0273060	6	1.44	6.35	15.88	4.78	●	●
MLPE 2532 NT 8P	0271080	8	1.04	4.78	12.70	3.81	●	●
MLPE 3425 NT 8P	0273080	8	1.04	6.35	15.88	4.78	●	●
MLPE 2532 NT 10P	0271100	10	0.81	4.78	12.70	3.81	●	●
MLPE 3425 NT 10P	0273100	10	0.81	6.35	15.88	4.78	●	●
MLPE 2532 NT 12P	0271120	12	0.72	4.78	12.70	3.81	●	●
MLPE 3425 NT 12P	0273120	12	0.72	6.35	15.88	4.78	●	●

ACME STUB THREADING MLPE

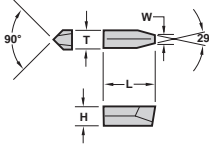

Description	EDP Code	TPI	W	T	L	H	Coating	
							TIN Coated	AlTiN Coated
MLPE 2532 NT 4P STUB	0271041	4	2.55	4.78	12.70	3.81	●	●
MLPE 3425 NT 4P STUB	0273041	4	2.55	6.35	15.88	4.78	●	●
MLPE 2532 NT 5P STUB	0271051	5	2.01	4.78	12.70	3.81	●	●
MLPE 3425 NT 5P STUB	0273051	5	2.01	6.35	15.88	4.78	●	●
MLPE 2532 NT 6P STUB	0271061	6	1.66	4.78	12.70	3.81	●	●
MLPE 3425 NT 6P STUB	0273061	6	1.66	6.35	15.88	4.78	●	●
MLPE 2532 NT 8P STUB	0271081	8	1.21	4.78	12.70	3.81	●	●
MLPE 3425 NT 8P STUB	0273081	8	1.21	6.35	15.88	4.78	●	●
MLPE 2532 NT 10P STUB	0271101	10	0.94	4.78	12.70	3.81	●	●
MLPE 3425 NT 10P STUB	0273101	10	0.94	6.35	15.88	4.78	●	●
MLPE 2532 NT 12P STUB	0271121	12	0.83	4.78	12.70	3.81	●	●
MLPE 3425 NT 12P STUB	0273121	12	0.83	6.35	15.88	4.78	●	●

V-THREADING - 60° MLPE

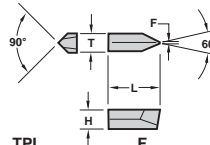

Description	EDP Code	TPI	W	T	L	H	Coating	
							TIN Coated	AlTiN Coated
MLPE 1251 NV	01720000	10-20	0.05-0.10	4.06	8.64	2.92	●	●
MLPE 2532 NV	01710000	6-20	0.05-0.10	4.78	12.70	3.81	●	●
MLPE 3425 NV	01730000	5-20	0.08-0.15	6.35	15.88	4.78	●	●

GROOVING MLPE

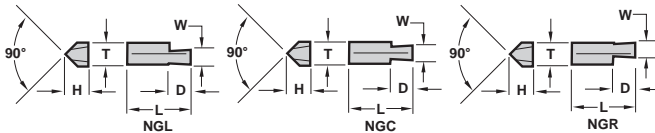

Description	EDP Code	W	D	T	L	H	Coating						
							C3	C6H	GP22	GP6	AC22	AC6	
MLPE 1251 NGC W.062	C7206200	1.57	2.16	4.06	8.64	2.92			●				
MLPE 1251 NGC W.094	C7209400	2.39	2.16	4.06	8.64	2.92			●				
MLPE 1251 NGC W.125	C7212500	3.18	2.16	4.06	8.64	2.92			●				
MLPE 1251 NGC W.156	C7215600	3.96	2.16	4.06	8.64	2.92			●				
MLPE 2532 NGC W.062	C7106200	1.57	3.05	4.78	12.70	3.81			●				
MLPE 2532 NGC W.094	C7109400	2.39	3.81	4.78	12.70	3.81			●				
MLPE 2532 NGC W.125	C7112500	3.18	3.81	4.78	12.70	3.81			●				
MLPE 2532 NGC W.156	C7115600	3.96	3.81	4.78	12.70	3.81			●				
MLPE 2532 NGC W.188	C7118800	4.78	3.81	4.78	12.70	3.81			●				
MLPE 3425 NGC W.062	C7306200	1.57	3.05	6.35	15.88	4.78			●				
MLPE 3425 NGC W.094	C7309400	2.39	3.81	6.35	15.88	4.78			●				
MLPE 3425 NGC W.125	C7312500	3.18	3.81	6.35	15.88	4.78			●				
MLPE 3425 NGC W.156	C7315600	3.96	3.81	6.35	15.88	4.78			●				
MLPE 3425 NGC W.188	C7318800	4.78	3.81	6.35	15.88	4.78			●				
MLPE 3425 NGC W.250	C7325000	6.35	3.81	6.35	15.88	4.78			●				
MLPE 1251 NGL W.125	L7212500	3.18	2.16	4.06	8.64	2.92			●				
MLPE 1251 NGL W.156	L7215600	3.96	2.16	4.06	8.64	2.92			●				
MLPE 2532 NGL W.125	L7112500	3.18	3.81	4.78	12.70	3.81			●				
MLPE 2532 NGL W.156	L7115600	3.96	3.81	4.78	12.70	3.81			●				
MLPE 3425 NGL W.188	L7318800	4.78	3.81	6.35	15.88	4.78			●				
MLPE 1251 NGR W.125	R7212500	3.18	2.16	4.06	8.64	2.92			●				
MLPE 1251 NGR W.156	R7215600	3.96	2.16	4.06	8.64	2.92			●				
MLPE 2532 NGR W.125	R7112500	3.18	3.81	4.78	12.70	3.81			●				
MLPE 2532 NGR W.156	R7115600	3.96	3.81	4.78	12.70	3.81			●				
MLPE 3425 NGR W.188	R7318800	4.78	3.81	6.35	15.88	4.78			●				

In an effort to improve our stock standard grade offering, there are periodic changes. Please see current price list for up to date grade offering.

- High performance choice in optimal conditions.
- ▲ Recommended grade under general conditions.

Cast Iron	●					
Non-Ferrous	●					
Stainless/High Temp	●					
Steel		▲	▲			●

VEE BOTTOM



INTERNAL BAR

MS-CDHOR/L

One piece design

■ RH Bars use RH clamps

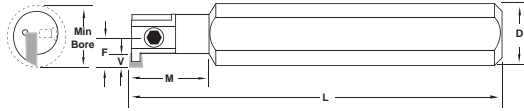

RH Shown

PARTS

Description	EDP Code	Insert	Min. Bore	D	M	L	F	V	Clamp Screw	Clamp
MS-CLHOR-46254	951546254	MLPE 1251	12.70	12.70	23.62	150	6.73	2.01	SFM30	MCR-30
MS-CLHOL-46254	951346254	MLPE 1251	12.70	12.70	23.62	150	6.73	2.01	SFM30	MCL-30
MS-CLHOR-6845	95156845	MLPE 2532	17.78	19.05	31.75	200	10.16	3.81	SFM47	MCR-40
MS-CLHOL-6845	95256845	MLPE 2532	17.78	19.05	31.75	200	10.16	3.81	SFM47	MCL-40
MS-CLHOR-6856	95156856	MLPE 3425	21.08	19.05	38.10	200	11.73	3.81	SAM4	MCR-50
MS-CLHOL-6856	95256856	MLPE 3425	21.08	19.05	38.10	200	11.73	3.81	SAM4	MCL-50
MS-CLHOR-8856	95158856	MLPE 3425	21.08	25.40	38.10	200	11.73	3.81	SAM4	MCR-50
MS-CLHOL-8856	95258856	MLPE 3425	21.08	25.40	38.10	200	11.73	3.81	SAM4	MCL-50

INTERCHANGEABLE HEADS

H-CDHOR/L*

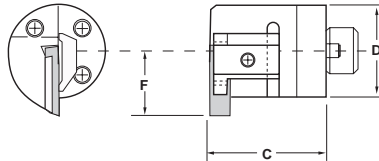

RH SHOWN

PARTS

Description	EDP Code	Insert	d	C	F	Min. Bore	Clamp	Clamp Screw
H25M-CDHOR-8	9IH68025M82	V84/V85	25	41.28	23.50	38.74	CBLM-84	SM526
H32M-CDHOR-8	9IH68032M82	V84/V85	32	41.28	22.23	40.64	CBLM-84	SM526
H40M-CDHOR-8	9IH68040M82	V84/V85	40	41.28	25.40	46.99	CBLM-84	SM526
H50M-CDHOR-8	9IH68050M82	V84/V85	50	41.28	32.64	60.58	CBLM-84	SM526
H60M-CDHOR-8	9IH68060M82	V84/V85	60	41.28	38.10	72.39	CBLM-84	SM526
H50M-CDHOR-9	9IH68050M86	V96/V98	50	41.28	35.81	63.75	CBL-98	SSM110
H60M-CDHOR-9	9IH68060M86	V96/V98	60	41.28	40.23	74.55	CBL-98	SSM110
H60M-CDHOR-12	9IH68060M92	V120	60	41.28	46.23	80.52	CBL-120	SBM100

*Left hand quoted on request.

HS-CDHOR/L*

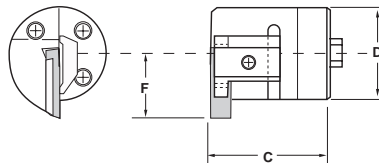

RH SHOWN

PARTS

Description	EDP Code	Insert	d	C	F	Min. Bore	Clamp	Clamp Screw
HS25-CDHOR-8	9IHS68025M82	V84/V85	25	34.42	23.50	38.53	CBLM-84	SM526
HS32-CDHOR-8	9IHS68032M82	V84/V85	32	41.28	22.23	40.64	CBLM-84	SM526
HS40-CDHOR-8	9IHS68040M82	V84/V85	40	41.28	27.53	50.06	CBLM-84	SM526
HS50-CDHOR-8	9IHS68050M82	V84/V85	50	41.28	32.54	60.10	CBLM-84	SM526
HS60-CDHOR-8	9IHS68060M82	V84/V85	60	41.28	37.49	70.00	CBLM-84	SM526
HS50-CDHOR-9	9IHS68050M86	V96/V98	50	41.28	34.59	62.15	CBL-98	SSM110
HS60-CDHOR-9	9IHS68060M86	V96/V98	60	41.28	39.57	72.09	CBL-98	SSM110
HS60-CDHOR-12	9IHS68060M92	V120	60	41.28	44.45	76.96	CBL-120	SBM100



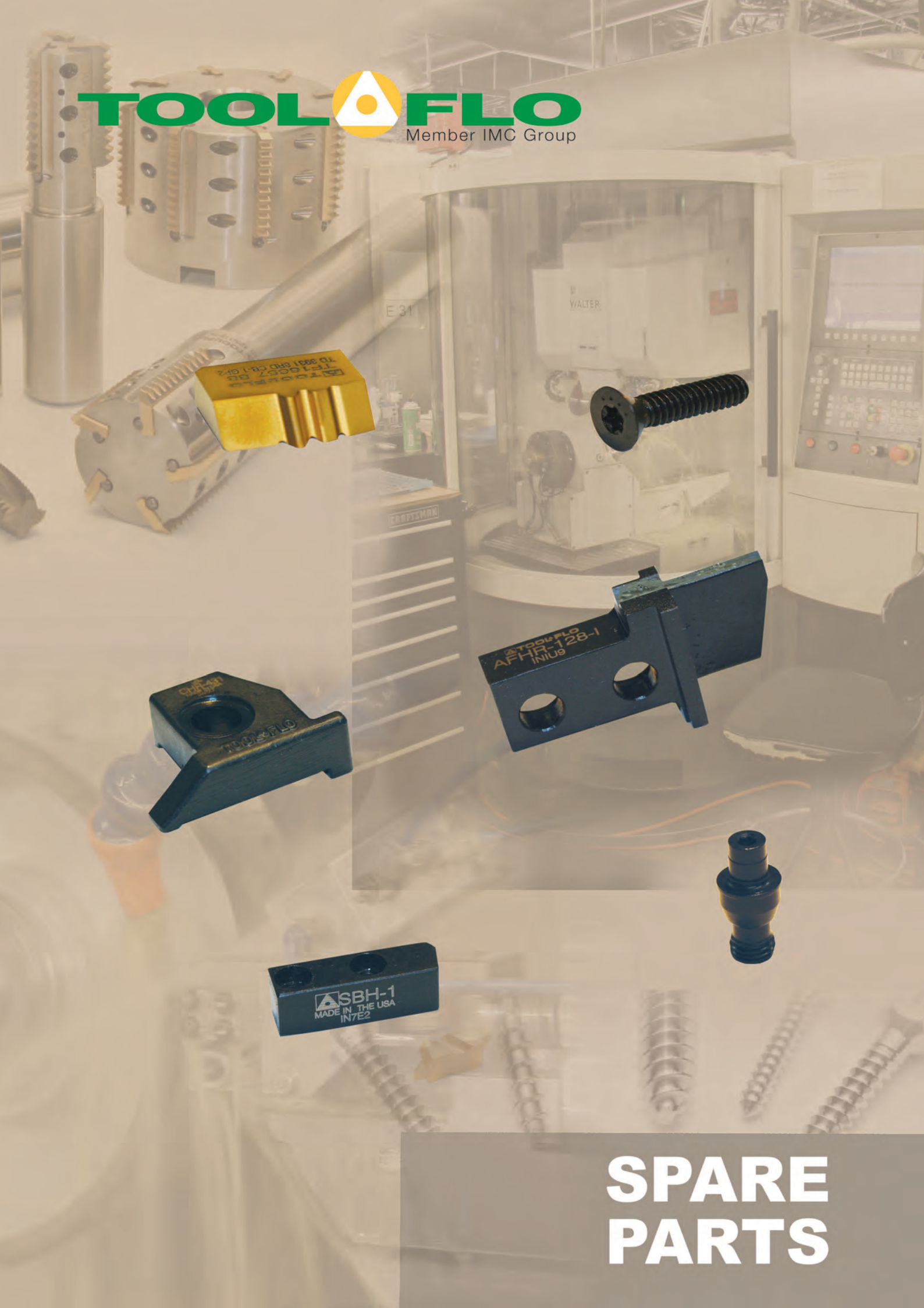







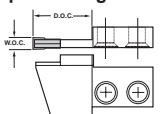
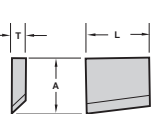



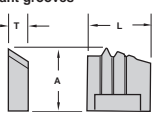

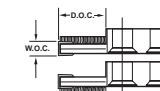

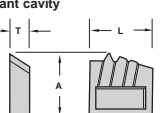
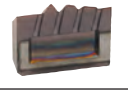
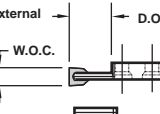

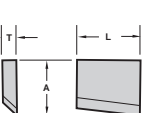

*Left hand quoted on request.

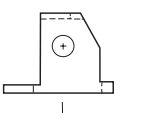

SPARE PARTS

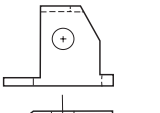









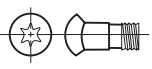

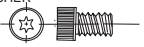

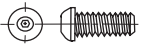

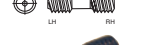

SPARE PARTS

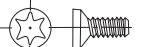

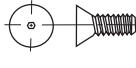
	Description	D.O.C.	W.O.C.	Insert		Description	Insert		
ANVILS Deep Grooving 	DGAHL-113	31.75	2.67-3.18	VDG	CHIPBREAKERS External  	CR 5B75/5B1-4E CB TF2993	CR-5B75-4E		
	DGAHR-113	31.75	2.67-3.18	VDG		CR 8R/10R-3E/4E CB 1353E	CR-8RD-3E		
	DGAHL-138	34.93	4.32-4.78	VDG		#3 CB w/o Coolant Grooves TF26424	CR-8R/10R-3E		
	DGAHR-138	34.93	4.32-4.78	VDG					
	DGAHL-248	38.10	5.54-6.35	VDG					
	DGAHR-248	38.10	5.54-6.35	VDG					
	DGAHL-258	38.10	6.35-7.93	VDG					
	DGAHR-258	38.10	6.35-7.93	VDG					
	DGAHL-268M	44.45	8.89-9.53	VDG					
	DGAHR-268M	44.45	8.89-9.53	VDG					
Grooving/Threading Internal  RH Shown 	ABL-113	7.92	2.67-3.18	DBP/VDB	External with coolant grooves  	TD4601 5B75-1 CB	CR-5B75-3E #1		
	ABR-113	7.92	2.67-3.18	DBP/VDB		TD4602 5B75-2 CB	CR-5B75-3E #2		
	ABL-131	4.57	4.78-6.35	V84/V85		TD4603 5B75-3 CB	CR-5B75-3E #3		
	ABR-131	4.57	4.78-6.35	V84/V85		TD3931 8RD-1 CB	CR-8R-3E #1		
	ABL-135	13.46	4.32-4.78	DBP/VDB		TD3932 8RD-2 CB	CR-8R-3E #2		
	ABR-135	13.46	4.32-4.78	DBP/VDB		TD3933 8RD-3 CB	CR-8R-3E #3		
	ABL-143	7.92	7.49-7.93	V84/V85		TA2237 10RD-1 CB	CR-10R-3E #1		
	ABR-143	7.92	7.49-7.93	V84/V85		TA2238 10RD-2 CB	CR-10R-3E #2		
	ABL-145	13.46	5.59-6.35	VDB 250A		TA2239 10RD-3 CB	CR-10R-3E #3		
	ABR-145	13.46	5.59-6.35	VDB 250A		#3 CB w/Coolant Grooves .170	CR-8R/10R-3E		
Face Grooving  RH Inside RH Outside 	AFHL-128-I	20.62	2.67-3.18	DBP/VDB	External with coolant cavity  	TD4601 5B75-1 CB W/CAVITY	CR-5B75-3E #1		
	AFHL-128-O	20.62	2.67-3.18	DBP/VDB		TD4602 5B75-2 CB W/CAVITY	CR-5B75-3E #2		
	AFHR-128-I	20.62	2.67-3.18	DBP/VDB		TD4603 5B75-3 CB W/CAVITY	CR-5B75-3E #3		
	AFHL-128-O	20.62	2.67-3.18	DBP/VDB		TD3931 8RD-1 CB W/CAVITY	CR-8R-3E #1		
	AFHL-138-I	20.62	4.32-4.78	DBP/VDB		TD3932 8RD-2 CB W/CAVITY	CR-8R-3E #2		
	AFHL-138-O	20.62	4.32-4.78	DBP/VDB		TD3933 8RD-3 CB W/CAVITY	CR-8R-3E #3		
	AFHR-138-I	20.62	4.32-4.78	DBP/VDB					
	AFHR-138-O	20.62	4.32-4.78	DBP/VDB					
	AFHL-148-I	20.62	5.59-6.35	DBP/VDB					
	AFHL-148-O	20.62	5.59-6.35	DBP/VDB					
External  RH Shown 	AHL-138	20.62	4.32-4.78	VDB	Internal  	CR 5B75/5B1-4I-CB TF16104	CR-5B75-4I		
	AHR-138	20.62	4.32-4.78	VDB		CR 8R/10R-3I/4I-CB TF1353	CR-8RD-3I		
	AHL-148	20.62	5.59-6.35	VDB		CR 5B75-5I-CB TF28765I	CR-5B75-5I		
	AHR-148	20.62	5.59-6.35	VDB		CR 8R-7I-CB TF3435I	CR-8RD-3I		
	AHL-173	20.62	V-THD	V84/V85					
	AHR-173	20.62	V-THD	V84/V85					
	AHL-248	20.62	6.35-7.93	VDB250B					
	AHR-248	20.62	6.35-7.93	VDB250B					
	AHL-248	20.62	6.35-7.93	VDB250B					
	AHR-248	20.62	6.35-7.93	VDB250B					
Cut Off    	AVR-FC094	12.70	2.39	FC-094	CLAMPS Internal  RH SHOWN  External  RH SHOWN 	CBLM-84	-	-	V84/V85
	AVR-FC125	20.32	3.18	FC-125		CBRM-84	-	-	V84/V85
	AVR-FC187	20.32	4.75	FC-187		CBL-98	-	-	V96/V98
	AVL-FC094	12.70	2.39	FC-094		CBR-98	-	-	V96/V98
	AVL-FC125	20.32	3.18	FC-125		CBL-120	-	-	V120
	AVL-FC187	20.32	4.75	FC-187		CBR-120	-	-	V120
	AVR/L-FCED125	20.32	3.18	FC-125		CBL-132	7.92	2.67-3.18	DBP/VDB
	AVR/L-FCED187	20.32	4.75	FC-187		CBR-132	7.92	2.67-3.18	DBP/VDB
	AVR-FCL094	12.70	2.39	FC-094		CBL-352	-	-	DBP/VDB
	AVR-FCL125	20.32	3.18	FC-125		CBR-352	-	-	DBP/VDB
AVR-FCL187  AVR-FCS094  AVR-FCS125  AVL-FCS094 AVL-FCS125 	AVR-FCL187	20.32	4.75	FC-187	CBL-411	4.57	4.78-6.35	V84/V85	
	AVR-FCL187	20.32	4.75	FC-187	CBR-411	4.57	4.78-6.35	V84/V85	
	AVR-FCL187	20.32	4.75	FC-187	CBL-452	13.46	5.59-6.35	DBP/VDB	
	AVR-FCL187	20.32	4.75	FC-187	CBR-452	13.46	5.59-6.35	DBP/VDB	
	AVR-FCL187	20.32	4.75	FC-187	CBL-531	7.92	7.49-7.93	V84/V85	
	AVR-FCL187	20.32	4.75	FC-187	CBL-531	7.92	7.49-7.93	V84/V85	
	AVR-FCS094	12.70	2.39	FC-094	CHL-98	-	-	V96/V98	
	AVR-FCS125	20.32	3.18	FC-125	CHR-98	-	-	V96/V98	
	AVL-FCS094	12.70	2.39	FC-094	CHL-120	-	-	V120	
	AVL-FCS125	20.32	3.18	FC-125	CHR-120	-	-	V120	

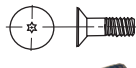
SPARE PARTS

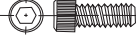





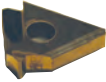

Description		Wrench			Description	Threads	Length	Wrench					
SCREWS Ballnose (Rigid-Lock)  	STBN-2		K3	Socket Head Torx Screw W/WASHER  	SYM-3	5-40	6.35	T-10 TORX					
	STBN-3		K3		SYM-4	8-32	9.53	T-20 TORX					
	STBN-4		K3										
	STBN-5		K3										
	STBN-6		K4										
	STBN-7		K5										
	STBN-8		K6										
	STBN-9		K7										
	STBN-10		K8										
	Button Head  	Description			Wrench		Special Flat Head Screw  	SB10	4-40	6.35	1/16 HEX	SL-344	4-40
SB90		5/16-18	19.05	3/16 HEX	S-34	10-32		2.34					
SB100		5/16-18	25.40	3/16 HEX	S-46	1/4-28							
SBM428		-	-	-	S-58	5/16-24							
SBM518		M4 x 0.7	9MM	2.25MM HEX	S-68	3/8-24							
SBM524		M5 x 0.8	12MM	2.0MM HEX	S-69								
SBM526		M5 x 0.8	10MM	3MM HEX	S-959	2-56		6.35	-				
SBM532		M6 x 1.0	19MM	4.0MM HEX									
SBM625		M6 x 1.0	22MM	4.0MM HEX									
SBM628		-	-	-									
Clamp Screw  		STCM8	M8 x 1.0	25MM	4.0MM HEX	TS Torx Head Screw  		TS1	1 - 72	2.38	T-6 TORX		
		STCM9	M5 x 0.8	15MM	2.5MM HEX			TS25	M2.5 x 0.45	5.5MM	T-8 TORX		
	STCM11	M6 x 1.0	20MM	3.0MM HEX	TS250		M2.5 x 0.45	4.8MM	T-8 TORX				
Flat Head Cap Screw  	S-111 (SF-20)	4 - 40	9.53	T-9 TORX	Differential Screw 	XNS-35	10 - 32	14.99	3/32 HEX				
	SAM3	M3.5 x 0.5	11MM	2.0 HEX		XNS-510	5/16 - 24	31.75	5/32 HEX				
	SAM4	M4 x 0.7	15MM	2.5 HEX		XNS-51	-	-	-				
	SAM5	M5 x 0.8	22MM	T-25 TORX		XNSM-0515	M5 x 0.8	15.0	2.5MM HEX				
	SFM10	M3 x 0.5	6MM	2.0MM HEX		XNSM-0825	M8 x 1.0	25.0	4.0MM HEX				
	SFM30	M3 x 0.5	10MM	2.0MM HEX									
	SFM40	M3.5 x 0.5	12MM	2.0MM HEX									
	SFM42	M3.5 x 0.5	15MM	2.0MM HEX									
	SFM45	M3.5 x 0.5	19MM	2.0MM HEX									
	SFM47	M3.5 x 0.5	13MM	2.0MM HEX									
	SFM48	M3.5 x 0.5	6MM	2.0MM HEX									
	SFM50	M5 x 0.7	10MM	2.5MM HEX									
	SFM60	M5 x 0.7	12MM	2.5MM HEX									
	SFM65	M5 x 0.8	13MM	3.0MM HEX									
	SFM69	M5 x 0.8	19MM	3.0MM HEX									
	SFM80	M5 x 0.8	13MM	3.0MM HEX									
	SFM85	M5 x 0.8	16MM	3.0MM HEX									
	SFM90	M8 x 1.25	25MM	5.0MM HEX									
	SFM95	M6 x 1.0	19MM	3.0MM HEX									
	SN-2T	M2.5 x 0.45	.265	T-8 TORX									
SN-3T	5 - 40	.375	T-8 TORX										
PT-324	5 - 40	9.53	1/16 HEX										
PT-586T	M3 x 0.5	.410	T-8 TORX										
SCREWS SD Torx Flat Head  	SD1	6 - 40	12.70	T-10TORX	SEATS Chaser Style 	Description		Insert					
	SD2	10 - 32	19.05	T-20TORX		TF1207	CR-8R-3E/4E						
	SD3	10 - 32	19.05	T-20TORX		TF1780	CR-8R-3I/4I						
	SD4	1/4 - 20	31.75	1/8 HEX		TF3218	CR-8R-7I						
	SDM-25	-	-	-		TF8132-E	CR-5B75-4E						
	SSM82	M5 x 0.8	16MM	-		TF8132-I	CR-5B75-4I						
Socket Head Cap Screw  	SM352 (SSM90)	5/16 - 18	25.40	1/4 HEX	SEATS Flo-Lock Style 	SM-267	FLPL-33						
	SM412	10 - 32	19.05	5/32 HEX		SM-268	FLPR-33						
	SSM20	4 - 40	9.53	3/32 HEX		SM-271	FLPL-13						
	SSM51	M4 x 0.7	20MM	3.0MM HEX		SM-272	FLPR-13						
	SSM61	M4 x 0.7	20MM	3.0MM HEX		SM-285	FLPR-5						
	SSM62	M3 x 0.5	10MM	2.5MM HEX		SM-286	FLPL-5						
	SSM63	M3 x 0.6	10MM	2.5MM HEX		SM-412	VPGR						
	SSM64	M4 x 0.7	12MM	3.0MM HEX		SM-414	DPGR						
	SSM65	M4 x 0.7	16MM	3.0MM HEX		SM-416	FL-6						
	SSM81	M5 x 0.8	18MM	4.0MM HEX		SM-420	FL-4						
	SSM82	-	-	-									
	SSM83	M8 x 1.25	20MM	5.0MM HEX									
	SSM85	M5 x 0.8	16MM	4.0MM HEX									
	SSM89	M5 x 0.8	10MM	4.0MM HEX									
	SSM90	M8 x 1.25	25MM	6.0MM HEX									
	SSM91	M5 x 0.8	12MM	3.0MM HEX									
	SSM94	M8 x 1.0	16MM	6.0MM HEX									
	SSM95	M8 x 1.0	25MM	6.0MM HEX									
	SSM100	M6 x 1.0	18MM	5.0MM HEX									
	SSM110	M6 x 1.0	25MM	5.0MM HEX									
	TS-61	M6 x 1.0	16MM	5.0MM HEX									

SPARE PARTS



SPARE PARTS

Description		Length		Description	Insert
SEATS (cont.) Laydown L Style 	LS 43 NO FORM EXT		L43 EXT	ICSN-432	CN -43
	LS 43 NO FORM INT		L43 INT	ICSN-433	CN -43
	LS 53 NO FORM EXT		L53 EXT	ICSN-533	CN -54
	LS 53 NO FORM INT		L53 INT	ICSN-633	CN -64
	LS 43 API EXT		L43 API EXT	IDSN-322	DN -33
	LS 43 API INT		L43 API INT	IDSN-433	DN -43
	LS 53 API EXT		L53 API EXT	IDSN-443	DN -43
	LS 53 API INT		L53 API INT	IDSN-533	DN -54
				IRSN-433	RN -43
				IRSN-533	RN -54
Laydown LT Style 	Description	Angle*	Insert	IRSN-633	RN -64
	YE3 3N	-1.5°	16ER/16NL	ISSN-322	SN -32
	YE3 2N	-0.5°	16ER/16NL	ISSN-433	SN -43
	YE3 1.5N	0°	16ER/16NL	ISSN-533	SN -54
	YE3 1N	0.5°	16ER/16NL	ISSN-633	SN -64
	YE3	1.5°	16ER/16NL	ISSN-844	SN -86
	YE3 1P	2.5°	16ER/16NL	ITSN-322	TN -32
	YE3 2P	3.5°	16ER/16NL	ITSN-323	TN -33
	YE3 3P	4.5°	16ER/16NL	ITSN-433	TN -43
	YE3M NO FORM	1.5°	16ER/16NL	ITSN-533	TN -53
	YE3M 1N	0.5°	16ER/16NL	ITSN-633	TN -66
	YE3M 1.5N	0°	16ER/16NL	ITSN-636	TN -64
	YE3M 2N	-0.5°	16ER/16NL	IVSN-322	VN -32
	YE4 3N	-1.5°	22ER/22NL	IVSN-324	VN -33
	YE4 2N	-0.5°	22ER/22NL	IVSN-433	VN -43
	YE4 1.5N	0°	22ER/22NL	IWSN-322	WN -32
	YE4 1N	0.5°	22ER/22NL	IWSN-323	WN -33
	YE4	1.5°	22ER/22NL	IWSN-433	WN -43
	YE4 1P	2.5°	22ER/22NL	RSN-43	RN -43
	YE4 2P	3.5°	22ER/22NL	RSN-63	RN -64
	YE4 3P	4.5°	22ER/22NL	RSN-84	RN -86
	YE4M NO FORM	1.5°	22ER/22NL	SSN-432	SN -43
	YE4M 1N	0.5°	22ER/22NL	SSN-632	SN -64
	YE4M 1.5N	0°	22ER/22NL	TSN-324	TN -32
	YE4M 2N	-0.5°	22ER/22NL	TSN-434	TN -43
	YE5 3N	-1.5°	27ER/27NL	TSN-534	TN -54
	YE5 2N	-0.5°	27ER/27NL	TSN-535	TN -54
	YE5 1.5N	0°	27ER/27NL	TSN-537	TN -54
	YE5 1N	0.5°	27ER/27NL	TSN-636	TN -66
	YE5	1.5°	27ER/27NL	TSN-637	TN -66
	YE5 1P	2.5°	27ER/27NL		
	YE5 2P	3.5°	27ER/27NL		
	YE5 3P	4.5°	27ER/27NL		
	YE5 8NPT 2M	1.5°	27ER/NL 8NPT 2M		
	YE5 8RD 2M	1.5°	27ER/NL 8RD 2M		
	YE5M NO FORM	1.5°	27ER/27NL		
	YE5M 1N	0.5°	27ER/27NL		
	YE5M 1.5N	0°	27ER/27NL		
	YI3 3N	-1.5°	16NR/16EL		
	YI3 2N	-0.5°	16NR/16EL		
	YI3 1.5N	0°	16NR/16EL		
	YI3 1N	0.5°	16NR/16EL		
	YI3	1.5°	16NR/16EL		
	YI3 1P	2.5°	16NR/16EL		
	YI3 2P	3.5°	16NR/16EL		
	YI3 3P	4.5°	16NR/16EL		
	YI3M NO FORM	1.5°	16NR/16EL		
YI3M 1N	0.5°	16NR/16EL			
YI3M 1.5N	0°	16NR/16EL			
YI3M 2N	-0.5°	16NR/16EL			
YI4 3N	-1.5°	22NR/22EL			
YI4 2N	-0.5°	22NR/22EL			
YI4 1.5N	0°	22NR/22EL			
YI4 1N	0.5°	22NR/22EL			
YI4	1.5°	22NR/22EL			
YI4 1P	2.5°	22NR/22EL			
YI4 2P	3.5°	22NR/22EL			
YI4 3P	4.5°	22NR/22EL			
YI4M NO FORM	1.5°	22NR/22EL			
YI4M 1N	0.5°	22NR/22EL			
YI4M 1.5N	0°	22NR/22EL			
YI4M 2N	-0.5°	22NR/22EL			
YI5 3N	-1.5°	27NR/27EL			
YI5 2N	-0.5°	27NR/27EL			
YI5 1.5N	0°	27NR/27EL			
YI5 1N	0.5°	27NR/27EL			
YI5	1.5°	27NR/27EL			
YI5 1P	2.5°	27NR/27EL			
YI5 2P	3.5°	27NR/27EL			
YI5 3P	4.5°	27NR/27EL			
YI5 8NPT 2M	1.5°	27NR/EL 8NPT 2M			
YI5 8RD 2M	1.5°	27NR/EL 8RD 2M			
YI5M NO FORM	1.5°	27NR/27EL			
YI5M 1N	0.5°	27NR/27EL			
YI5M 1.5N	0°	27NR/27EL			
Ring Grooving 	Description	Length			
	FGS-1A	FGNR-2525-1A			
FGS-2ANL	FGNR-2525-2A				
Turning 	Description			Insert	
	STOP BLOCKS			Description	
				SBH-1	
				SBH-2	
				SBH-4	
	WRENCHES Flag Style Torx 			Description	
				Wrench	
				K05 T-6 TORX	
				K1 T-7 TORX	
				K2 T-8 TORX	
K3 T-10 TORX					
			K4 T-20 TORX		
			K5 T-25TORX		
			K05L T-6 TORX		
			K2L T-8 TORX		
			K3L T-10 TORX		
			K35L T-15TORX		
			K4L T-20 TORX		
			K5L T-25TORX		

SPARE PARTS



Infeed Values for Threading Operations

External ISO Threads --- Recommendations for Steel Workpieces (<300BHN)

PITCH (mm)	6.0	5.5	5.0	4.5	4.0	3.5	3.0	2.5	2.0	1.75	1.5	1.25	1.0	0.75	0.5
# OF PASSES	Reduce cutting speed →														
1	0.016	0.017	0.016	0.015	0.013	0.013	0.011	0.011	0.010	0.009	0.009	0.007	0.007	0.007	0.004
2	0.017	0.016	0.015	0.013	0.013	0.012	0.010	0.010	0.009	0.008	0.008	0.007	0.007	0.006	0.004
3	0.014	0.013	0.013	0.011	0.010	0.010	0.008	0.008	0.007	0.006	0.006	0.006	0.005	0.004	0.003
4	0.012	0.011	0.011	0.009	0.009	0.008	0.007	0.007	0.006	0.006	0.006	0.005	0.004	0.003	0.003
5	0.011	0.009	0.009	0.009	0.007	0.007	0.006	0.006	0.006	0.005	0.005	0.004	0.003	0.020	0.014
6	0.009	0.009	0.009	0.008	0.007	0.007	0.006	0.005	0.005	0.004	0.003	0.003	0.026		
7	0.009	0.008	0.008	0.007	0.006	0.006	0.005	0.005	0.004	0.004	0.038	0.032			
8	0.008	0.007	0.007	0.007	0.006	0.006	0.005	0.004	0.003	0.003					
9	0.008	0.007	0.007	0.006	0.006	0.006	0.005	0.004	0.050	0.045					
10	0.007	0.007	0.007	0.006	0.005	0.005	0.004	0.003							
11	0.007	0.006	0.006	0.006	0.005	0.004	0.004	0.063							
12	0.006	0.006	0.006	0.005	0.005	0.003	0.003								
13	0.006	0.005	0.005	0.005	0.004	0.087	0.074								
14	0.006	0.005	0.004	0.004	0.003										
15	0.005	0.005	0.123	0.111	0.099										
16	0.004	0.004													
	0.147	0.135													

Infeed Values for Threading Operations

Internal ISO Threads --- Recommendations for Steel Workpieces (<300BHN)

PITCH (mm)	6.0	5.5	5.0	4.5	4.0	3.5	3.0	2.5	2.0	1.75	1.5	1.25	1.0	0.75	0.5
# OF PASSES	Reduce cutting speed →														
1	0.018	0.015	0.015	0.014	0.013	0.012	0.011	0.011	0.010	0.009	0.010	0.008	0.007	0.007	0.004
2	0.016	0.014	0.014	0.013	0.012	0.011	0.009	0.009	0.009	0.008	0.008	0.007	0.006	0.005	0.004
3	0.014	0.012	0.012	0.011	0.009	0.009	0.008	0.007	0.007	0.006	0.006	0.005	0.004	0.004	0.003
4	0.011	0.010	0.010	0.009	0.008	0.008	0.006	0.006	0.006	0.005	0.004	0.004	0.004	0.003	0.003
5	0.009	0.009	0.009	0.008	0.007	0.007	0.006	0.006	0.005	0.004	0.004	0.004	0.003	0.019	0.014
6	0.009	0.008	0.009	0.007	0.006	0.006	0.006	0.005	0.004	0.004	0.003	0.003	0.024		
7	0.008	0.007	0.007	0.006	0.006	0.006	0.005	0.004	0.004	0.004	0.035	0.031			
8	0.007	0.007	0.006	0.006	0.006	0.006	0.004	0.004	0.003	0.003					
9	0.007	0.006	0.006	0.006	0.005	0.005	0.004	0.004	0.048	0.043					
10	0.006	0.006	0.006	0.006	0.005	0.004	0.004	0.003							
11	0.006	0.006	0.006	0.005	0.004	0.004	0.004	0.059							
12	0.006	0.006	0.006	0.005	0.004	0.003	0.003								
13	0.006	0.006	0.005	0.004	0.004	0.081	0.070								
14	0.006	0.005	0.004	0.004	0.003										
15	0.005	0.005	0.114	0.104	0.092										
16	0.004	0.004													
	0.136	0.126													



Infeed Values for Threading Operations

External UN Threads --- Recommendations for Steel Workpieces (<300BHN)

TPI	4	5	6	7	8*	9	10	11	12	13	14	16	18	20	24	28	32	36	40	44	48
THREAD DEPTH	4.008	3.205	2.672	2.291	2.004	1.781	1.603	1.458	1.336	1.232	1.146	1.001	0.889	0.800	0.668	0.572	0.500	0.445	0.399	0.363	0.333
# OF PASSES																					
1	0.897	0.757	0.630	0.541	0.500	0.445	0.429	0.399	0.386	0.361	0.345	0.318	0.315	0.302	0.300	0.284	0.249	0.221	0.198	0.185	0.165
2	0.371	0.310	0.267	0.224	0.208	0.185	0.178	0.168	0.163	0.145	0.150	0.137	0.135	0.124	0.122	0.117	0.107	0.091	0.081	0.071	0.069
3	0.287	0.239	0.198	0.196	0.160	0.142	0.135	0.122	0.122	0.112	0.109	0.099	0.099	0.099	0.099	0.091	0.079	0.071	0.071	0.056	0.051
4	0.241	0.201	0.170	0.150	0.135	0.119	0.114	0.104	0.107	0.094	0.091	0.086	0.084	0.081	0.079	0.079	0.066	0.061	0.051	0.051	0.048
5	0.213	0.178	0.147	0.127	0.119	0.107	0.099	0.091	0.091	0.084	0.081	0.074	0.074	0.071	0.069						
6	0.193	0.160	0.132	0.114	0.109	0.094	0.091	0.079	0.081	0.076	0.074	0.066	0.066	0.064							
7	0.178	0.147	0.122	0.104	0.099	0.086	0.079	0.071	0.074	0.069	0.066	0.061	0.061	0.058							
8	0.165	0.137	0.114	0.097	0.091	0.081	0.076	0.066	0.069	0.064	0.061	0.056	0.056								
9	0.155	0.130	0.107	0.091	0.086	0.076	0.074	0.064	0.066	0.061	0.058	0.053									
10	0.145	0.122	0.102	0.086	0.081	0.071	0.071	0.061	0.064	0.058	0.056	0.051									
11	0.137	0.114	0.097	0.081	0.079	0.069	0.069	0.058	0.058	0.056	0.053										
12	0.132	0.109	0.091	0.079	0.074	0.066	0.066	0.056	0.056	0.053											
13	0.124	0.107	0.089	0.076	0.069	0.064	0.064	0.053													
14	0.122	0.104	0.086	0.074	0.066	0.061	0.061	0.051													
15	0.117	0.102	0.084	0.071	0.064	0.058															
16	0.112	0.099	0.081	0.069	0.064	0.056															
17	0.109	0.097	0.079	0.066																	
18	0.107	0.094	0.076	0.064																	
19	0.104																				
20	0.099																				

Infeed Values for Threading Operations

Internal UN Threads --- Recommendations for Steel Workpieces (<300BHN)

TPI	4	5	6	7	8	9	10	11	12	13	14	16	18	20	24	28	32	36	40	44	48
THREAD DEPTH	3.437	2.748	2.291	1.963	1.717	1.527	1.374	1.250	1.146	1.057	0.980	0.859	0.762	0.686	0.572	0.490	0.429	0.381	0.343	0.312	0.284
# OF PASSES																					
1	0.770	0.648	0.541	0.465	0.429	0.381	0.368	0.335	0.333	0.305	0.297	0.272	0.269	0.259	0.257	0.244	0.213	0.191	0.170	0.155	0.142
2	0.318	0.267	0.229	0.193	0.185	0.157	0.163	0.140	0.137	0.127	0.122	0.109	0.112	0.107	0.107	0.099	0.089	0.079	0.074	0.064	0.058
3	0.244	0.211	0.175	0.147	0.135	0.119	0.117	0.112	0.104	0.097	0.094	0.086	0.084	0.081	0.081	0.084	0.069	0.058	0.053	0.048	0.043
4	0.206	0.173	0.145	0.124	0.119	0.102	0.097	0.089	0.089	0.081	0.079	0.071	0.071	0.069	0.069	0.064	0.058	0.053	0.046	0.046	0.028
5	0.180	0.152	0.127	0.109	0.104	0.089	0.086	0.079	0.079	0.071	0.069	0.064	0.064	0.061	0.058						
6	0.163	0.137	0.114	0.099	0.091	0.081	0.079	0.071	0.071	0.064	0.064	0.074	0.058	0.056							
7	0.150	0.127	0.104	0.091	0.084	0.074	0.071	0.066	0.066	0.058	0.058	0.053	0.053	0.053							
8	1.397	0.117	0.097	0.084	0.076	0.069	0.066	0.061	0.061	0.056	0.053	0.051	0.074								
9	0.132	0.109	0.091	0.079	0.071	0.064	0.061	0.056	0.056	0.053	0.051	0.048									
10	0.124	0.104	0.086	0.074	0.069	0.061	0.058	0.053	0.053	0.051	0.048	0.046									
11	0.117	0.099	0.081	0.071	0.066	0.058	0.056	0.051	0.051	0.048	0.046										
12	0.112	0.094	0.079	0.069	0.064	0.056	0.053	0.048	0.048	0.046											
13	0.107	0.091	0.076	0.066	0.061	0.053	0.051	0.046													
14	0.104	0.089	0.074	0.064	0.058	0.051	0.048	0.043													
15	0.102	0.086	0.071	0.061	0.056	0.048															
16	0.099	0.084	0.069	0.058	0.053	0.048															
17	0.097	0.081	0.066	0.056																	
18	0.094	0.079	0.064	0.053																	
19	0.091																				
20	0.089																				



Infeed Values for Threading Operations

External ACME Threads- For Steel Workpieces (<300BHN)

# OF INFEEDS	Pitch Threads/inch Reduce cutting speed →							
	4	5	6	8	10	12	14	16
	Radial infeed per pass (inch)							
1	0.014	0.013	0.013	0.011	0.010	0.010	0.009	0.009
2	0.013	0.013	0.011	0.010	0.009	0.008	0.008	0.008
3	0.012	0.010	0.009	0.008	0.008	0.007	0.007	0.007
4	0.011	0.009	0.008	0.007	0.007	0.006	0.006	0.006
5	0.010	0.009	0.007	0.006	0.006	0.005	0.005	0.005
6	0.010	0.008	0.007	0.005	0.005	0.005	0.004	0.003
7	0.008	0.008	0.006	0.005	0.005	0.004	0.003	0.038
8	0.008	0.008	0.006	0.005	0.004	0.004	0.042	
9	0.008	0.007	0.006	0.005	0.004	0.049		
10	0.007	0.006	0.006	0.004	0.004			
11	0.007	0.006	0.006	0.004	0.062			
12	0.006	0.006	0.005	0.004				
13	0.006	0.005	0.004	0.074				
14	0.006	0.004	0.094					
15	0.006	0.112						
16	0.005							
	0.137							

Infeed Values for Threading Operations

Internal ACME Threads- For Steel Workpieces (<300BHN)

# OF INFEEDS	Pitch Threads/inch Reduce cutting speed →							
	4	5	6	8	10	12	14	16
	Radial infeed per pass (inch)							
1	0.015	0.013	0.013	0.011	0.011	0.010	0.009	0.009
2	0.013	0.012	0.011	0.010	0.009	0.008	0.008	0.008
3	0.012	0.010	0.009	0.008	0.008	0.007	0.007	0.007
4	0.011	0.009	0.008	0.007	0.007	0.006	0.006	0.006
5	0.010	0.008	0.007	0.006	0.006	0.005	0.005	0.005
6	0.009	0.008	0.006	0.006	0.005	0.005	0.004	0.003
7	0.008	0.008	0.006	0.005	0.005	0.004	0.003	0.038
8	0.008	0.008	0.006	0.005	0.004	0.004	0.042	
9	0.008	0.007	0.006	0.005	0.004	0.049		
10	0.007	0.006	0.006	0.004	0.004			
11	0.007	0.006	0.006	0.004	0.063			
12	0.006	0.006	0.005	0.004				
13	0.006	0.005	0.004	0.075				
14	0.006	0.004	0.093					
15	0.005	0.110						
16	0.005							
	0.136							

Infeed Values for Threading Operations

Internal STUB ACME Threads- For Steel Workpieces (<300BHN)

# OF INFEEDS	Pitch Threads/inch Reduce cutting speed →							
	4	5	6	8	10	12	14	16
	Radial infeed per pass (inch)							
1	0.012	0.011	0.011	0.009	0.009	0.009	0.008	0.007
2	0.011	0.010	0.009	0.008	0.007	0.006	0.006	0.005
3	0.010	0.008	0.008	0.007	0.006	0.005	0.005	0.005
4	0.008	0.008	0.007	0.006	0.006	0.004	0.005	0.004
5	0.008	0.007	0.006	0.006	0.006	0.004	0.004	0.004
6	0.007	0.006	0.006	0.006	0.005	0.004	0.028	0.025
7	0.006	0.006	0.006	0.005	0.004	0.032		
8	0.006	0.006	0.005	0.004	0.043			
9	0.005	0.005	0.004	0.051				
10	0.005	0.004	0.062					
11	0.004	0.071						
12	0.004							
	0.086							

Infeed Values for Threading Operations

External STUB ACME Threads-Steel Workpieces (<300BHN)

# OF INFEEDS	Pitch Threads/inch Reduce cutting speed →							
	4	5	6	8	10	12	14	16
	Radial infeed per pass (inch)							
1	0.012	0.011	0.011	0.010	0.009	0.009	0.009	0.008
2	0.011	0.010	0.008	0.008	0.008	0.007	0.007	0.006
3	0.010	0.008	0.008	0.008	0.007	0.006	0.006	0.005
4	0.008	0.008	0.007	0.007	0.006	0.005	0.005	0.004
5	0.008	0.007	0.006	0.006	0.006	0.004	0.004	0.004
6	0.007	0.006	0.006	0.006	0.005	0.004	0.031	0.027
7	0.006	0.006	0.006	0.005	0.004	0.035		
8	0.006	0.006	0.005	0.004	0.045			
9	0.005	0.005	0.004	0.054				
10	0.005	0.004	0.061					
11	0.004	0.071						
12	0.004							
	0.086							



ACME TABLE (Inch)				
PITCH	REGULAR		STUB	
	WIDTH	DEPTH	WIDTH	DEPTH
16	.0206	.0362	.0238	.0238
14	.0239	.0407	.0276	.0264
12	.0283	.0467	.0326	.0300
10	.0319	.0600	.0370	.0400
9	.0360	.0656	.0417	.0433
8	.0411	.0725	.0476	.0475
7	.0478	.0814	.0551	.0529
6	.0566	.0933	.0652	.0600
5	.0689	.1100	.0793	.0700
4	.0875	.1350	.1004	.0850
3-1/2	.1007	.1529	.1155	.0957
3	.1184	.1767	.1356	.1100
2-1/2	.1431	.2100	.1638	.1300
2	.1802	.2600	.2060	.1600
1-1/2	.2419	.3433	.2764	.2100
1-1/3	.2728	.3850	.3116	.2350
1	.3655	.5100	.4172	.3100

We welcome specials! Please call us with your specs.

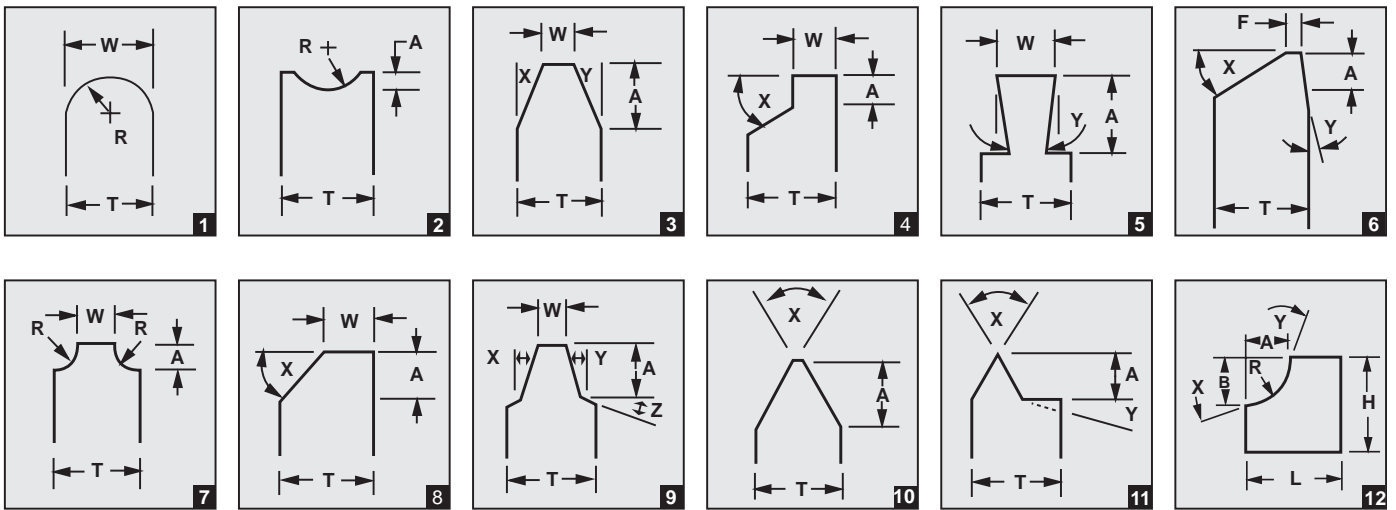

TECHNICAL



Trouble Shooting & Optimizing Tool Life/ Threading Economy

Modern PVD grades and insert geometries have done much to improve the productivity and reliability of thread turning. They have also helped to eliminate or minimize problems in threading. The following chart lists problems, in order of severity, which may still occur in modern threading.

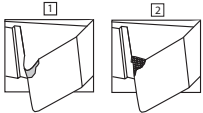
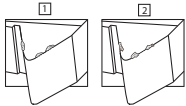
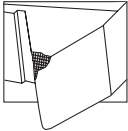
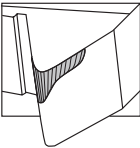
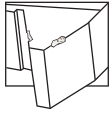
Problem	Cause	Solution	Problem	Cause	Solution
Plastic Deformation  <p>Starts as plastic deformation (1) which leads to plastic break (2)</p>	Excessive temperature in the cutting area Unsuitable grade Inadequate coolant supply	Reduce cutting speed Increase number of infeeds Reduce the largest infeed depth Check diameter before threading Improve coolant supply Choose grade with better resistance to plastic deformation	Poor Chip Control	Incorrect method of infeed Wrong geometry	Modified Flank infeed 3P-5P "CB" or "HCB" geometry with modified flank infeed 1P
Built-up Edge/ Edge Spalling  <p>Built-up edge (1) and edge spalling (2) often occur in combination. Built-up edge accumulates and is then ripped away taking insert material with it</p>	Cutting edge temperature too low Stainless material; CMC codes 05.2, 05.51, and 05.52 Low carbon steel Unsuitable grade	Increase cutting speed Choose an insert with good toughness, preferably PVD coated	Shallow Profile	Wrong center height Insert breakage Excessive wear	Adjust the center height Change cutting edge
Insert Breakage 	Wrong Diameter prior to threading operation Infeed series too tough Unsuitable grade Poor chip control Center height incorrect	Turn to correct diameter before threading--0.0012-0.0028 radially larger than maximum diameter for thread Increase number of infeeds Reduce size of the large infeeds Choose a tougher grade Change to "CB" geometry and use modified flank infeed Correct center height	Incorrect Thread Profile	Unsuitable thread profile angle of thread and nose radius; external inserts used for internal operation and vice versa Wrong center height Holder not 90° to center line Pitch error in machine	Correct tool / insert combination Adjust the center height Adjust to 90° Correct in machine
Rapid Flank Wear 	Highly abrasive material Cutting speed too high Infeed depths too shallow Insert is above centerline	Choose a more wear resistant grade Reduce cutting speed Reduce number of infeeds Correct center height	Excessive Edge Pressure 	Work hardening material in combination with infeed depths which are too shallow Excessive pressure on cutting edge Profile with too small thread profile angle	Reduce the number of infeeds Change to "CB" or "HCB" geometry Use a tougher grade Use incremental flank infeed
Abnormal Flank Wear Poor Finish on One Flank of Thread	Incorrect method for flank infeed Insert's inclination angle does not agree with thread's lead angle	Change method of infeed Change shim to obtain correct angle of inclination	Vibration	Incorrect clamping work piece Incorrect set-up of the tool Incorrect cutting data Incorrect center height	Use softer jaws Minimize overhang of tool Check that the clamping sleeve for bars is not worn Increase cutting speed; if this does not help lower speed dramatically Use constant infeed series Try "CB" or "HCB" geometry Adjust the center height Use heavy metal, solid carbide or carbide cored bar.
Poor Surface Quality on Thread	Cutting speed too low The insert is above center Uncontrolled chips	Increase cutting speed Adjust center height Use "CB" or "HCB" geometry and modified flank infeed			



Optional Infeed Angles for Threading Applications

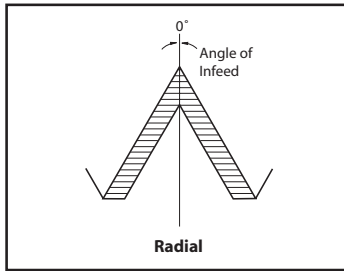

Advantage-

Cutting on both sides of the thread form places all of the cutting edge in the cut and protects edge from chipping.

Disadvantage-

Tool develops a channel chip which may be difficult to handle.

Tip chipping occurs when cutting high-tensile materials.

Burr condition is increased.

Entire cutting edge is engaged at finish of thread, causing increased tendency to chatter.

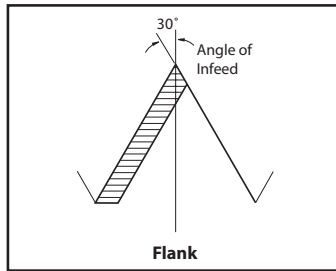

Advantage-

Cutting with the leading edge of the threading tool gives the chip a definite flow out of the thread form area. This reduces the burr problem on the trailing edge of the tool. To avoid bad surface finish, chipping, or excessive flank wear due to rubbing of the trailing edge, the infeed angle should be 3° to 5° smaller than the angle of the thread. This is a type of modified flank.

Disadvantage-

Trailing edge of threading insert may drag or rub, and tends to chip. Torn or poor surface finish threads result when cutting soft, gummy materials such as low carbon steels, aluminum, and stainless steels.

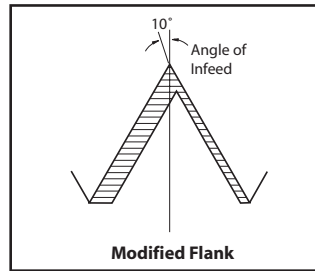

Advantage-

Tool cuts both sides of thread form and, therefore, is protected from chipping similar to 0° infeed. Channel-type chip develops but uneven chip thickness helps remove the chip similar to flank infeed.

Disadvantage-

Similar disadvantages as with 0P infeed, although slightly reduced in magnitude as the cutting forces are better equalized and chip flow is much less of a problem.

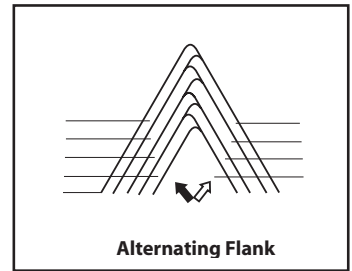

Advantage-

Increased tool life because both edges are used equally. NOTE: Some machine tools may require special programming techniques to achieve this method.

Disadvantage-

Difficult to cut on conventional machinery.

*For premium performance based upon optimal machining conditions, select the grade that will provide you with the highest allowable SFM for the material that is being machined. Optimum grades are in bold print. Grades are specific to certain insert styles. The grades listed below in bold print are stock within the style listed, see appropriate catalog page for precise stocking status.

Bantam: C22 GP4 AC22 GP22	Flo-Lock: C25 GP3 GP4 GP5 GP50 AC22 AC3 AC50 GPM6 CB200 CB400 PC33 C22 C3 Laydown: (LT style) GP22 GP4 GP50 AC22 AC50 C22	Laydown: GP22 GP3 GP5 GP50 AC22 C22 Milling: GP5 C5H On Edge: GP22 GP3 GP54 GP50 GPM6 AC22 AC3 AC50 AC54 C22 C25 C3	Threadmill: C3 GP3 GP22 Turning: G525 (Negative) AG525 AG535 AG615 Turning: AC3 (Positive) AC50 C3 V-Bottom: GP3 (V84/V85) GP50 AC50 C3 V-Bottom: C3 (VDB/VDG) GP3 AC3 AC50 CB200/CB400
--	--	--	---



Recommended SFM for Grooving Applications

	Free Machining Carbon Steels	Plain Carbon Steels	Alloy Steels 190-330 HB	Alloy Steels 330-450 HB	Martensitic/Ferritic Stainless Steel 400 Series	Austenitic Stainless 300 Series	Gray Cast Iron 190-330 HB	Gray Cast Iron 330-450 HB	Alloy / Ductile Irons	Free Machining Aluminum Alloys	High-Silicon Aluminum Alloys	Copper / Zinc / Brass	Non-Metallics	High Temperature Alloys 200-260 HB	High Temperature Alloys 260-450 HB	Titanium Alloys (Ti 6Al-4V)	Hardened Materials 48-65 HRC
C22	---	---	---	---	---	45.7-91.4	30.5-106.7	30.5-91.4	---	30.5-457.2	---	30.5-152.4	30.5-304.8	24.4-39.6	15.2-30.5	30.5-60.9	---
C25	---	---	---	---	---	60.9-106.7	30.5-114.3	30.5-106.7	---	60.9-518.2	---	60.9-182.9	121.9-365.8	24.4-39.6	15.2-30.5	30.5-60.9	---
C26S	---	---	---	---	---	---	---	---	---	457.2-914.4	---	121.9-243.8	121.9-365.8	---	---	---	---
C3	---	---	---	---	---	60.9-121.9	30.5-114.3	30.5-106.7	---	60.9-609.6	---	60.9-213.4	121.9-426.7	24.4-39.6	15.2-30.5	30.5-60.9	---
G50	91.4-213.4	91.4-213.4	91.4-213.4	91.4-182.9	91.4-182.9	---	---	---	91.4-182.9	---	---	---	---	---	---	---	---
GP22	45.7-91.4	45.7-91.4	45.7-91.4	45.7-91.4	45.7-91.4	45.7-121.9	45.7-121.9	45.7-106.7	45.7-91.4	45.7-609.6	---	45.7-213.4	152.4-457.2	30.5-53.3	24.4-45.7	30.5-76.2	---
GP25	45.7-91.4	45.7-91.4	45.7-91.4	45.7-91.4	45.7-91.4	45.7-121.9	45.7-121.9	45.7-106.7	45.7-91.4	45.7-609.6	---	45.7-213.4	152.4-457.2	30.5-53.3	24.4-45.7	30.5-76.2	---
GP26	121.9-243.8	121.9-243.8	91.4-182.9	60.9-152.4	91.4-182.9	60.9-152.4	121.9-243.8	91.4-182.9	91.4-182.9	365.8-1066.8	---	91.4-2438.4	91.4-365.8	30.5-60.9	30.5-60.9	30.5-76.2	---
GP3	60.9-121.9	60.9-121.9	60.9-121.9	60.9-106.7	60.9-121.9	60.9-152.4	60.9-182.9	60.9-152.4	30.5-60.9	91.4-609.6	---	60.9-274.3	91.4-457.2	30.5-60.9	30.5-53.3	45.7-91.4	---
GP4	18.3-53.3	18.3-53.3	18.3-45.7	18.3-45.7	18.3-45.7	18.3-45.7	18.3-45.7	18.3-45.7	18.3-45.7	18.3-45.7	---	---	---	15.2-24.3	15.2-24.4	15.2-24.4	---
GP5	60.9-152.4	60.9-152.4	60.9-121.9	60.9-121.9	60.9-121.9	---	---	---	60.9-121.9	---	---	---	---	---	---	---	---
GP54	60.9-152.4	60.9-152.4	60.9-121.9	60.9-121.9	60.9-121.9	---	---	---	60.9-121.9	---	---	---	---	---	---	---	---
GP50	60.9-182.9	60.9-182.9	60.9-152.4	60.9-137.2	60.9-152.4	---	---	---	60.9-152.4	---	---	---	---	---	---	---	---
AC22	76.2-152.4	76.2-152.4	76.2-137.2	76.2-121.9	60.9-137.2	91.4-182.9	91.4-182.9	60.9-167.6	76.2-137.2	182.9-670.6	---	91.4-274.3	106.7-365.8	24.4-60.9	24.4-53.3	24.4-91.4	---
AC26	152.4-304.8	152.4-304.8	121.9-243.8	91.4-182.9	121.9-243.8	91.4-213.4	152.4-304.8	121.9-243.8	121.9-243.8	457.2-1524.0	---	121.9-304.8	121.9-457.2	30.5-60.9	30.5-60.9	60.9-91.4	---
AC3	76.2-137.2	76.2-137.2	76.2-121.9	76.2-121.9	76.2-137.2	76.2-213.4	91.4-213.4	91.4-182.9	60.9-137.2	182.9-762.0	---	121.9-304.8	121.9-457.2	30.5-76.2	30.5-60.9	30.5-91.4	24.4-45.7
AC54	106.7-152.4	106.7-152.4	106.7-152.4	91.4-152.4	91.4-152.4	---	---	---	91.4-152.4	---	---	---	---	---	---	---	---
AC50	121.9-243.8	137.2-243.8	121.9-243.8	121.9-228.6	106.7-213.4	---	---	---	91.4-213.6	---	---	---	---	---	---	---	---
ZA22	76.2-152.4	76.2-152.4	76.2-137.2	76.2-121.9	60.9-137.2	91.4-182.9	91.4-182.9	60.9-167.6	76.2-137.2	182.9-670.6	---	91.4-274.3	106.7-365.8	24.4-60.9	24.4-53.3	24.4-91.4	---
ZA26	152.4-304.8	152.4-304.8	121.9-243.8	91.4-182.9	121.9-243.8	91.4-213.4	152.4-304.8	121.9-243.8	121.9-243.8	457.2-1524.0	---	121.9-304.8	121.9-457.2	30.5-60.9	30.5-60.9	60.9-91.4	---
ZA3	76.2-137.2	76.2-137.2	76.2-121.9	76.2-121.9	76.2-137.2	76.2-213.4	91.4-213.4	91.4-182.9	60.9-137.2	182.9-762.0	---	121.9-304.8	121.9-457.2	30.5-76.2	30.5-60.9	30.5-91.4	24.4-45.7
ZA50	121.9-243.8	137.2-243.8	121.9-243.8	121.9-228.6	106.7-213.4	---	---	---	91.4-213.4	---	---	---	---	---	---	---	---
ZL22	76.2-152.4	76.2-152.4	76.2-137.2	76.2-121.9	60.9-137.2	91.4-182.9	91.4-182.9	60.9-167.6	76.2-137.2	182.9-670.6	---	91.4-274.3	106.7-365.8	24.4-60.9	24.4-53.3	24.4-91.4	---
ZL26	152.4-304.8	152.4-304.8	121.9-243.8	91.4-182.9	121.9-243.8	91.4-213.4	152.4-304.8	121.9-243.8	121.9-243.8	457.2-1524.0	---	121.9-304.8	121.9-457.2	30.5-60.9	30.5-60.9	60.9-91.4	---
ZL3	76.2-137.2	76.2-137.2	76.2-121.9	76.2-121.9	76.2-137.2	76.2-213.4	91.4-213.4	91.4-182.9	60.9-137.2	182.9-762.0	---	121.9-304.8	121.9-457.2	30.5-76.2	30.5-60.9	30.5-91.4	24.4-45.7
ZR22	76.2-152.4	76.2-152.4	76.2-137.2	76.2-121.9	60.9-137.2	91.4-182.9	91.4-182.9	60.9-167.6	76.2-137.2	182.9-670.6	---	91.4-274.3	106.7-365.8	24.4-60.9	24.4-53.3	24.4-91.4	---
ZR26	152.4-304.8	152.4-304.8	121.9-243.8	91.4-182.9	121.9-243.8	91.4-213.4	152.4-304.8	121.9-243.8	121.9-243.8	457.2-1524.0	---	121.9-304.8	121.9-457.2	30.5-60.9	30.5-60.9	60.9-91.4	---
ZR3	76.2-137.2	76.2-137.2	76.2-121.9	76.2-121.9	76.2-137.2	76.2-213.4	91.4-213.4	91.4-182.9	60.9-137.2	182.9-762.0	---	121.9-304.8	121.9-457.2	30.5-76.2	30.5-60.9	30.5-91.4	24.4-45.8
ZR50	121.9-243.8	137.2-243.8	121.9-243.8	121.9-228.6	106.7-213.4	---	---	---	91.4-213.4	---	---	---	---	---	---	---	---
ZS22	76.2-152.4	76.2-152.4	76.2-137.2	76.2-121.9	60.9-137.2	91.4-182.9	91.4-182.9	60.9-167.6	76.2-137.2	182.9-670.6	---	91.4-274.3	106.7-365.8	24.4-60.9	24.4-53.3	24.4-91.4	---
ZS26	152.4-304.8	152.4-304.8	121.9-243.8	91.4-182.9	121.9-243.8	91.4-213.4	152.4-304.8	121.9-243.8	121.9-243.8	457.2-1524.0	---	121.9-304.8	121.9-457.2	30.5-60.9	30.5-60.9	60.9-91.4	---
ZS3	76.2-137.2	76.2-137.2	76.2-121.9	76.2-121.9	76.2-137.2	76.2-213.4	91.4-213.4	91.4-182.9	60.9-137.2	182.9-762.0	---	121.9-304.8	121.9-457.2	30.5-76.2	30.5-60.9	30.5-91.4	24.4-45.7
ZS50	121.9-243.8	137.2-243.8	121.9-243.8	121.9-228.6	106.7-213.4	---	---	---	91.4-213.4	---	---	---	---	---	---	---	---
ZU22	76.2-152.4	76.2-152.4	76.2-137.16	76.2-121.9	60.9-137.2	91.4-182.9	91.4-182.9	60.9-167.6	76.2-137.2	182.9-670.6	---	91.4-274.3	106.7-365.8	24.4-60.9	24.4-53.3	24.4-91.4	---
ZU26	152.4-304.8	152.4-304.8	121.9-243.8	91.4-182.9	121.9-243.8	91.4-213.4	152.4-304.8	121.9-243.8	121.9-243.8	457.2-1524.0	---	121.9-304.8	121.9-457.2	30.5-60.9	30.5-60.9	60.9-91.4	---
ZU3	76.2-137.16	76.2-137.16	76.2-121.92	76.2-121.9	76.2-137.2	76.2-213.4	91.4-213.4	91.4-182.9	60.9-137.2	182.88-762.0	---	121.9-304.8	121.9-457.2	30.5-76.2	30.5-60.9	30.8-91.4	24.4-45.7
ZU50	121.9-243.8	137.2-243.8	121.9-243.8	121.9-228.6	106.7-213.4	---	---	---	91.4-213.4	---	---	---	---	---	---	---	---
GPM6	182.9-457.2	182.9-365.8	152.4-335.3	182.9-243.8	152.4-243.8	152.4-304.8	121.9-335.3	106.7-289.6	106.7-289.6	---	---	---	---	---	---	---	---
CB200	---	---	---	---	---	---	121.9-762.0	304.8-548.6	---	---	---	---	---	91.4-182.9	76.2-137.2	---	45.7-106.7
CB400	---	---	---	---	---	---	---	---	---	---	---	---	---	---	---	---	60.9-152.4
PC33	---	---	---	---	---	---	---	---	---	304.8-2438.4	304.8-1524.0	304.8-1219.2	304.8-1371.6	---	---	---	---
DX200	---	---	---	---	---	---	---	---	---	304.8-2133.6	304.8-914.4	304.8-1066.8	304.8-1219.2	---	---	---	---



Zenith

TOOL-FLO's
New Premium Coatings

Grade Name	ANSI range	ISO range	Coating	Description
C2	C1-C2	K05-K15	Uncoated	Uncoated general purpose C2 grade. Good for all non-ferrous materials.
C22	C1	K30	Uncoated	Uncoated grade with a tough, micro-grain, unalloyed substrate. Good for threading at low to medium speeds, while capable of handling interruptions. Works well in stainless steel, high-temperature alloys, and standard steels at low to medium SFM.
C25	C1-C2	K05-K10 M05-M10	Uncoated	Uncoated general purpose C2 grade. Good for all non-ferrous materials.
C26S	C1	K30-K40	Uncoated	Uncoated grade with a tough, fine grain, unalloyed substrate. Main uncoated grade for Rigid-lock endmill inserts. Edge is up-sharp for use in non-ferrous and composite applications.
C3	C3	K15-K25 M05-M20	Uncoated	Uncoated micro-grain C3 grade. Versatile grade that combines high hardness with toughness. Good for all non-ferrous, stainless steel, and nickel-based alloys at low to medium SFM.
GFI	C1-C5A	K30/P30	Uncoated	Uncoated extremely tough grade that perform well at very slow SFPM with minimal breakage or chipping.
C5	C5	P10-P35 M15-M30	Uncoated	Uncoated general purpose C5 grade. Good for all carbon/alloy steels at low to medium SFM.
C6	C6	P15-P20 M10-M20	Uncoated	Uncoated general purpose C5/C6 harder grade. Good for all carbon/alloy steels at low to medium SFM.
GP2	C1-C2	K05-K15	PVD TiN coated	PVD TiN coated grade. Works well in stainless steel, high-temperature alloys, and standard steels at low to medium SFM.
GP22	C1	K30	PVD TiN coated	PVD TiN grade with a tough, micro-grain substrate. Good for threading at low to medium speeds, while capable of handling interruptions. Works well in stainless steel, high-temperature alloys, and standard steels at low to medium SFM.
GP25	C1-C2	K05-K10 M05-M10	PVD TiN coated	PVD TiN coated general purpose C2 grade. Good for all non-ferrous materials at low to medium SFM.
GP26	C1	K30-K40	PVD TiN coated	PVD TiN grade with a tough, micro-grain, unalloyed substrate. Rigid-Lok endmill grade. Good choice for steels, stainless, high-temperature alloys, and non-ferrous materials. Good in low to high SFM, will handle interruptions and high feed rates.
GP3	C3	K15-K25 M05-M20	PVD TiN coated	PVD TiN grade with a wear resistant micro-grain substrate. Excellent choice in stainless steels, high-temperature alloys, aerospace materials, and non-ferrous materials. Good in standard steels at low to medium SFM.
GP4	C1-C5A	K30/P30	PVD TiN coated	PVD TiN grade with our toughest substrate. First choice at low SFM (50-150) applications and heavy interruptions. Used in all applications where tool breakage is an issue.
GP44	C5A	P35-P50	PVD TiN coated	PVD TiN coated extremely tough sub-micron grade that perform well at very slow SFPM with minimal breakage or chipping.
GP5	C5	P10-P35 M15-M30	PVD TiN coated	PVD TiN grade with a medium tough substrate. Good general purpose grade for steel applications. Primary grade in LPGC and TPGC style inserts.
GP50	C5	P10-P35 M15-M30	PVD TiN coated	PVD TiN grade with a medium tough substrate and excellent wear properties. Great general purpose grade for steel applications.
GP54	C5A	P35-P50	PVD TiN coated	PVD TiN grade with a tough substrate.
GP6	C6	P15-P20 M10-M20	PVD TiN coated	PVD TiN coated general purpose grade. Good for all carbon/alloy steels at medium SFM.
AC2	C1-C2	K05-K15	PVD AlTiN coated	PVD AlTiN coated grade with a tough, micro-grain, unalloyed substrate. Good for threading at low to medium speeds, while capable of handling interruptions. Works well in stainless steel, high-temperature alloys, and standard steels at low to medium SFM.
AC22	C1	K30	PVD AlTiN coated	PVD TiAlN grade with a tough, micro-grain substrate. First choice in Laydown Threading in all materials. Dry machining capable.
AC25	C1-C2	K05-K10 M05-M10	PVD AlTiN coated	PVD AlTiN coated general purpose C2 grade. Good for all non-ferrous materials at medium to high SFM.
AC26	C1	K30-K40	PVD AlTiN coated	PVD TiAlN grade with a tough, fine grain, unalloyed substrate with excellent wear properties. First choice in Rigid-Lock inserts for steels, stainless, high-temp alloys, and non-ferrous materials. Performs very well at low to high SFM and will handle interruptions and high feed rates. Coating provides highest resistance to oxidation, physical abrasion, and chip welding. Dry machining capable.
AC3	C3	K15-K25 M05-M20	PVD AlTiN coated	PVD TiAlN grade. First choice for grooving and threading in stainless steel, high-temperature alloys, aerospace materials, and non-ferrous materials. Excellent in standard steels at medium SFM. Dry machining capable.
AC5	C5	P10-P35 M15-M30	PVD AlTiN coated	PVD AlTiN coated general purpose grade. Good for all carbon/alloy steels at medium to high SFM.
AC50	C5	P10-P35 M15-M30	PVD AlTiN coated	PVD TiAlN grade. First choice for grooving and threading in all standard steels and 400 series stainless. Application range is medium to high SFM. Dry machining capable.
AC54	C5A	P35-P50	PVD AlTiN coated	PVD AlTiN coated grade. Good for all carbon/alloy steels at medium SFM.
AC6	C6	P15-P20 M10-M20	PVD AlTiN coated	PVD AlTiN coated grade. Good for all carbon/alloy steels at medium SFM.



Grade Name	ANSI range	ISO range	Coating	Description
ZA22	C1	K30	PVD AlTiN coated	PVD TiAlN grade with a tough, micro-grain substrate. Dry machining capable.
ZA26	C1	K30-K40	PVD AlTiN coated	PVD TiAlN grade with a tough, fine grain, unalloyed substrate with excellent wear properties. First choice in Rigid-Lock inserts for steels, stainless, high-temp alloys, and non-ferrous materials. Performs very well at low to high SFM and will handle interruptions and high feed rates. Coating provides highest resistance to oxidation, physical abrasion, and chip welding. Dry machining capable.
ZA3	C3	K15-K25 M05-M20	PVD AlTiN coated	PVD TiAlN grade. First choice for grooving in stainless steel, high-temperature alloys, aerospace materials, and non-ferrous materials. Excellent in standard steels at medium SFM. Dry machining capable.
ZA50	C5	P10-P35 M15-M30	PVD AlTiN coated	PVD TiAlN grade. First choice for grooving and threading in all standard steels and 400 series stainless. Application range is medium to high SFM. Dry machining capable.
ZS22	C1	K30	PVD AlTiN coated	PVD AlTiN grade with a tough, micro-grain substrate. Good in Laydown Threading in all materials. Dry machining capable.
ZS26	C1	K30-K40	PVD AlTiN coated	PVD AlTiN grade with extra lubricity, a tough, fine grain, unalloyed substrate with excellent wear properties. First choice in Rigid-Lock inserts for steels, stainless, high-temp alloys, and non-ferrous materials. Performs very well at low to high SFM and will handle interruptions and high feed rates. Coating provides highest resistance to oxidation, physical abrasion, and chip welding. Dry machining capable.
ZS3	C3	K15-K25 M05-M20	PVD AlTiN coated	PVD AlTiN grade for grooving and threading in stainless steel, high-temperature alloys, aerospace materials, and non-ferrous materials. Excellent in standard steels at medium SFM. Dry machining capable.
ZS50	C5	P10-P35 M15-M30	PVD AlTiN coated	PVD AlTiN grade for grooving and threading in all standard steels and 400 series stainless. Application range is medium to high SFM. Dry machining capable.
ZL22	C1	K30	PVD AlTiN coated	PVD grade with a tough, micro-grain, unalloyed substrate. Good for turning at low to medium speeds, while capable of handling interruptions. Works well in high-temperature alloys and aluminum.
ZL26	C1	K30-K40	PVD AlTiN coated	PVD grade with a tough, micro-grain, unalloyed substrate. Rigid-Lok endmill grade. Good choice for aluminum, high-temperature alloys, and non-ferrous materials. Good in low to high SFM, will handle interruptions and high feed rates.
ZL3	C3	K15-K25 M05-M20	PVD AlTiN coated	PVD grade with a wear resistant micro-grain substrate. Excellent choice in high-temperature alloys, aerospace materials, and non-ferrous materials.
ZR22	C1	K30	PVD AlTiN coated	PVD AlTiN grade with a tough, micro-grain, unalloyed substrate. Good for threading at low to medium speeds, while capable of handling interruptions. Works well in stainless steel, high-temperature alloys, and standard steels at low to medium SFM.
ZR26	C1	K30-K40	PVD AlTiN coated	PVD AlTiN grade with a tough, micro-grain, unalloyed substrate. Rigid-Lok endmill grade. Good choice for steels, stainless, high-temperature alloys, and non-ferrous materials. Good in low to high SFM, will handle interruptions and high feed rates.
ZR3	C3	K15-K25 M05-M20	PVD AlTiN coated	PVD AlTiN grade with a wear resistant micro-grain substrate. Excellent choice in stainless steels, high-temperature alloys, aerospace materials, and non-ferrous materials. Good in standard steels at low to medium SFM.
ZR50	C5	P10-P35 M15-M30	PVD AlTiN coated	PVD AlTiN grade with a medium tough substrate and excellent wear properties. Great general purpose grade for steel applications.
ZU22	C1	K30	PVD AlTiN coated	PVD AlTiN grade with a tough, micro-grain, unalloyed substrate. Good for threading at low to medium speeds, while capable of handling interruptions. Works well in stainless steel, high-temperature alloys, and standard steels at low to medium SFM.
ZU26	C1	K30-K40	PVD AlTiN coated	PVD AlTiN grade with a tough, micro-grain, unalloyed substrate. Rigid-Lok endmill grade. Good choice for steels, stainless, high-temperature alloys, and non-ferrous materials. Good in low to high SFM, will handle interruptions and high feed rates.
ZU3	C3	K15-K25 M05-M20	PVD AlTiN coated	PVD AlTiN grade with a wear resistant micro-grain substrate. Excellent choice in stainless steels, high-temperature alloys, aerospace materials, and non-ferrous materials. Good in standard steels at low to medium SFM.
ZU50	C5	P10-P35 M15-M30	PVD AlTiN coated	PVD AlTiN grade with a medium tough substrate and excellent wear properties. Great general purpose grade for steel applications.
GPM6	C6/C7	P1-P10 K1-K10	PVD TiN coated Cermet	PVD TiN coated cermet grade. First choice for grooving in high-speed finishing of most carbon, alloy, and stainless steels. Performs very well in cast and ductile irons. Provides excellent workpiece finishes.
G50	C5	P10-P35 M15-M30	CVD coated	CVD TiN/TiC/TiN grade. API chaser grade for Q-Series material.
CB200	C8	K01	PCBN	PCBN tip brazed onto a carbide insert. High content CBN. First choice for cast iron and high-temperature alloys. Suited for roughing to finishing in hardened steels greater than 45 HRC, such as bearing steel, hot and cold work tool steels, high-speed steels, die steels, case hardened steels, nitrided irons, and some hard coatings.
CB400	C8		PCBN	PCBN tip brazed onto a carbide insert. Low content CBN. First choice for roughing to finishing of hardened steels 45 HRC and higher. Use on bearing steel, hot and cold work steels, die steels, case hardened steels, carburized and nitrided irons.
CB410	C8		PCBN	PCBN tip brazed onto a carbide insert. Low content CBN. First choice for roughing to finishing of hardened steels 45 HRC and higher. Use on bearing steel, hot and cold work steels, die steels, case hardened steels, carburized and nitrided irons.
PC33			PCD	PCD tip brazed onto a carbide insert. First choice for high silicone aluminum applications at high SFM. Use on all types of highly abrasive materials including non-ferrous metals and non-metallics. High SFM only!
DX200	C1-C2	K05-K15	PCD CVD coated	PCD CVD coated grade. Rigid-Lock insert grade. First choice at high SFM in non-metallic materials such as graphite, epoxy based resins, plastics and aluminum.

ORDERING INFORMATION

CONDITION OF SALE

Sales are made in accordance with our standard Conditions of Sale current at the time orders are accepted. Specifications and prices subject to change without notice.

QUOTATIONS

Will be subject to acceptance 60 days from the date of quotation unless otherwise agreed. **In order to receive special quoted pricing, a quote number must be referenced at the time the order is placed.**

TERMS OF PAYMENT

Net 30 Days

DELIVERY TERMS

F.O.B. Shipping point; Charges will be added to invoice.

WARRANTY

We will replace any material which is proven defective within 90 days from date of shipment to the customer. No claim for labor or damage will be allowed. Claims for error must be made upon receipt of material.

PRICING

So far as the resale of items in this price list is concerned, the prices referred to are to be regarded as suggested only. The distributor, in its sole discretion, determines the actual resale price. These suggested resale prices are based on quantities of identical items released by purchaser on one order for shipment at one time to one destination. The reseller should determine whether savings in cost can justify the suggested quantity price differential, as may be required by the Robinson-Patman Act or other applicable law.

OVER AND UNDER SHIPMENTS

For Non-Stock or Special items, unless otherwise specified or agreed, the following over and under allowances may be made:

Lots of	10-19	20-49	50-99	100+
Over/Under	1 piece	2 pieces	3 pieces	5%

MINIMUM ORDER

\$50 Net per order. For Extended Discount Program - \$100 Net per order.

RETURNS

Each Distributor will be allowed at a certain time of year to exchange 1% of their Net Sales for the previous year up to a maximum of \$1,000. These exchanges will be limited to Stock Standard items only and will be replaced by such. The exchange schedule is as follows:

Group A Distributors:	January - March
Group B Distributors:	July - September
Group C Distributors:	April - June
Group D Distributors:	October - December

All Non-Stock and Specials are non-returnable and/or non-exchangeable.

A Returned Material Authorization (RMA) number must be assigned by Tool-Flo prior to any material being returned. Purchase Order numbers and original invoice numbers must be supplied before an RMA number can be issued.

RELEASE ORDER POLICY

- A. Prices are to be based on total quantity of each item. Prices will be firm for six (6) months from the date of purchase. In the event of a price increase during the term of the order, one of the following conditions will apply:
1. If the increase becomes effective during the first six (6) months of the order, the balance of the order can be released within six (6) months from the date of purchase at existing prices. Any subsequent releases will be invoiced at the new price.
 2. If the increase becomes effective after the first six (6) months of the order, the balance can be released immediately upon notification of the price increase at existing prices. All items not released immediately will be invoiced at the new price.
- B. Minimum release order is 400 pieces. Releases must be made every 30 days. Initial release must be made within 30 days of order date. Minimum release is 50 pieces every 30 days. Releases not to exceed twelve (12) months. At the end of the twelve (12) month period from the date of the order, any remaining pieces will be shipped.



11.....	10, 115, 118	DGCHL/R.....	73	HS-MTFNL/R.....	203	TBFI.....	39
16.....	10-13, 111-128	DNGA.....	159,160	HS-MTHOL/R.....	23,24,156	TBNR.....	36
22.....	10-13, 115-117	DNMG.....	182	HS-MVUNL/R.....	203	TBRR.....	37
27.....	11-13, 115-117	DPGR.....	166	HS-MWLNL/R.....	204	TBNC.....	38
A-FLDLPL.....	169	FC.....	68	IDR.....	26,125-131	TBNS.....	37
A-FLDLPR.....	169	FCBM.....	46	L43.....	14,15,17,125-129	TBXR.....	37
A-FLEL.....	103	FCEDVOR.....	69	L53.....	14,15,17,125-129	TCMT.....	184
A-FLELT.....	75,104	FCIVOR.....	68	LDS.....	14-17,127-130	TCN.....	174
A-FLER.....	103	FCVOR.....	68,69	LFL/R.....	133	TCP.....	177
A-FLERT.....	75,104	FGNR.....	22	LN.....	131	TCS.....	177
A-FLKLCL.....	170	FLA.....	94,95	LNCX.....	138	TCT.....	173
A-FLKLCR.....	170	FLAS.....	94,95	LNFL/R.....	133,134	TD.....	7,63,64
A-FLKQCL.....	170	FLASL/R.....	59,102	LNTL/R.....	134	TDAB.....	46
A-FLKQCR.....	170	FLD.....	8,96	LPGC.....	126,130,131	TDCG.....	46
A-FLKXCL.....	170	FLDC.....	8,9,96-98	LTL/R.....	134	TE.....	195
A-FLKXCR.....	170	FLDLPL.....	167	MCFNL/R.....	185	TF_CP.....	106
A-FLSL/R.....	80	FLDLPR.....	167	MCGNL/R.....	185	TFHD.....	34
A-FLVLCL.....	170	FLDPPN.....	168	MCKNL/R.....	185	TFL/R.....	195
A-FLVLCR.....	170	FLEL.....	79,102	MCLNL/R.....	186	TFM.....	139
A-MFLEL/R.....	103	FLELT.....	103	MCMNN.....	186	TFMG.....	139
ABL/R.....	214	FLER.....	79,102	MCRNL/R.....	186	TGL/R.....	195
AFHL/R.....	81	FLERT.....	103	MDJNL/R.....	187	TI1N.....	175-177
AHL/R.....	213	FLF.....	78,89	MDPNN.....	187	TI1P.....	172-175
AHL/R-FC.....	69	FLF-CB.....	78,89	MLPE.....	215	TI15N.....	175-177
AL.....	59,121	FLFD.....	78,80	MRGNL/R.....	187	TI75P.....	172-174
APKT.....	138	FLFD-CB.....	78,80	MS-CLHOL/R.....	216	TNEB.....	150,153
APIP.....	21	FLFD-I.....	91	MSDNN.....	188	TNFA.....	17,130
AVL/R-FCED.....	70	FLFD-I-CB.....	91	MSKNL/R.....	188	TNGA.....	161
AVL/R-FCL.....	69	FLFT.....	79,92	MSRNL/R.....	189	TNMA.....	18,19,142-150,153,159
AVL/R-FCS.....	68	FLG.....	85-87,163	MSSNL/R.....	189	TNMC.....	18,19,142-151,153
AVR.....	122	FLG-CB.....	33,85	MTANL/R.....	190	TNMG.....	183
B10.....	27,28	FLGD.....	91	MTCNN.....	190	TNPGC.....	131
B12.....	28	FLGD-CB.....	91	MTENNS.....	190	TPCB.....	48
B6.....	28	FLGP.....	87	MTENR.....	132	TPCG.....	48
B64.....	28	FLGT.....	73,92	MTFNL/R.....	190	TPG.....	138
B8.....	27,28	FLJ.....	98	MTGNL/R.....	191	TPGC.....	126,127,131
B85.....	28	FLJF.....	98	MTHOL/R.....	154	TPMA.....	142-144,151,153
B86.....	28	FLJK.....	99	MTJNL/R.....	191	TPMC.....	142-144,152,153
BBM.....	47,50,54	FLJP.....	98	MTLNL/R.....	191	TSHI.....	178
BBCM.....	57	FLKLCR/R.....	168	MTRNL/R.....	192	TSSI.....	178
BFRM (3).....	47,49,53	FLKCLF/RF.....	169	MTVNL/R.....	132	TSSX.....	178
BFRM (4).....	48, 49,51,44	FLKPCN.....	169	MTVOL/R.....	154	V120.....	208,212
BFR3.....	48,51,55	FLPGL/R.....	166	MTWNL/R.....	192	V84.....	20,21,208,209,212
BFR4.....	52,55,59	FLPL/R.....	166	MVJNL/R.....	192	V85.....	20,21,208,209,212
BHRM.....	53,56	FLR.....	87,88,163	MVLNL/R.....	192	V96.....	208,212
BHR4.....	56	FLR-CB.....	87	MVNNL/R.....	193	V98.....	212
BHV.....	53	FLRD.....	91	MVTNL/R.....	193	VCMT.....	184
BNBR.....	47	FLRL.....	102	MWLNL/R.....	193	VDB.....	80,81,163,211,212
BNGR/L.....	50,57	FLRP.....	89	NVR.....	122	VDB-CB.....	81,210,211
BNPR.....	47	FLRR.....	102	PCFNR.....	64	VDG.....	72
BNRR/L.....	50	FLRT.....	74,92	PV.....	32	VNGA.....	162
BNVR/L.....	54,57	FLSL.....	79,101	QCBI.....	48	VNMG.....	183
BSBR.....	46	FSLT.....	81,85	QSBI.....	48	VPGR.....	167
BSGR.....	49	FLSR.....	79,101	RAL/R.....	194	WNMG.....	183
BSRM.....	46,49,52	FLSRT.....	74,79,103	SBH.....	87,216-218		
BSVR.....	52	FLT.....	100	SBL/R.....	194		
BTBL.....	49	FLT-CB.....	100	SCMT.....	184		
BTBR.....	49	FLTB.....	96	SEKN.....	138		
BTGL.....	51	FLTC.....	99	SI-CDHOR.....	214		
BTGR.....	51	FLTF.....	100	SI-CHORM.....	65		
BTLM.....	49,51	FLTK.....	100	SI-CLHOR.....	64		
BTRM.....	49,51	FLTP.....	101	SI-MCLNL/R.....	196		
BTRL.....	51,56	FLU.....	101	SI-MDJNL/R.....	196		
BTRR.....	51	FLV.....	33,101	SI-MSKNL/R.....	196		
BTVL.....	56	FLVLCL/R.....	167	SI-MTFNL/R.....	197		
BTVR.....	56	FLVVCN.....	168	SI-MTHOL/R.....	155		
CCBM.....	45	FSBI.....	50	SI-MVJNL/R.....	197		
CCMT.....	184	GC.....	210	SI-MVLNL/R.....	197		
CDCD.....	45	GR.....	211	SI-MVPNL/R.....	198		
CDCG.....	45	GTB.....	155	SI-MWLNL/R.....	198		
CDHOL/R.....	81,213,214	H-AVR.....	23,122	SI-PCLHORM.....	65		
CDVOC.....	214	H-BLANK.....	25	SI-SCFCL/R.....	198		
CDVOL/R.....	69,213	H-CDHOL/R.....	24,216	SI-SCLCL/R.....	199		
CEDVOL/R.....	73	H-FLER3.....	22,104	SI-SDUCL/R.....	199		
CHL/R.....	213	H-LNFL/R.....	22,132	SI-STFCL/R.....	199		
CHL/R-FC.....	69	H-MCLNL/R.....	201	SI-STHOL/R.....	156		
CHL/R-FCED.....	70	H-MDUNL/R.....	201	SI-STUCL/R.....	200		
CHL/R-FCL.....	69	H-MSKNL/R.....	202	SNGA.....	160		
CHL/R-FCS.....	68	H-MTFNL/R.....	202	SNMG.....	183		
CLVOR/L.....	64,81	H-MTHOL/R.....	23,156	SPG.....	138		
CNGA.....	159	H-MVUNL/R.....	203	SPUB.....	26		
CNMG.....	182	H-MWLNL/R.....	203	SQ86.....	26		
CNMM.....	182	HS-AVR.....	23,122	S-44.....	25,200		
CPGM.....	166	HS-BLANK.....	25	S-570.....	25,200		
CR.....	6,7,62-64	HS-CDHOL/R.....	24,216	STCNR.....	33		
CSBM.....	45	HS-FLER3.....	22,111	STVOL/R.....	154		
DBP.....	210	HS-LNFL/R.....	23,132	TAL/R.....	194		
DBV.....	34	HS-MCLNL/R.....	201	TBDC.....	79		
DCMT.....	184	HS-MDUNL/R.....	202	TBDI.....	39		
DGAHL/R.....	73	HS-MSKNL/R.....	202	TBDS.....	39		

The Source For All Your Cutting Tool Needs! 38 Years!

Call us toll free: 1-800-345-2815



Tool-Flo Manufacturing Inc.

7803 Hansen Road

Houston, TX 77061

Phone: (713) 941-1080, (800) 345-2815

Fax: (713) 941-8099 (800) 342-0992

Customer Service:

(800) 345-2815

Fax: (800) 342-0992

sales@toolflo.com